



# aquatherm orange system

**Surface heating system**  
for old and new buildings



**aquatherm**  
state of the pipe



Our sales and delivery conditions (January 2012) and the contacts of our technical sales and distribution see on our homepage [www.aquatherm.de](http://www.aquatherm.de).

Subject to technical alterations, errors and misprints excepted. With the edition of this catalogue, all former ones become void.



Dear customers...

...since ancient times, mankind has been thinking of effective ways of transporting and using "aqua" (lat. for water) and "therm" (lat. for warmth).

Applied technologies have been developed and changed considerably over the ages, but the motivation has remained the same: Hygiene, health and well-being.

aquatherm has participated in this development over the past 40 years and in some areas has been able to make decisive contributions. An example is the aquatherm green pipe-system produced by aquatherm.

By constantly adapting its products to the needs of the market and developing the relevant know-how, aquatherm has achieved worldwide success and prestige within the last 40 years: a fact which we are proud of, but at the same time giving us the motivation to continue making constant improvements.

This documentation is to give you a first idea of our products and services - and to make you curious to gain more information.

In case of further questions and of course also suggestions, we and our team will be pleased to be at your disposal!

**Christof Rosenberg**  
Managing Director

**Dirk Rosenberg**  
Managing Director

**Maik Rosenberg**  
Managing Director

**Gerhard Rosenberg**  
President of the Advisory Board

- 1973
- Founding of aquatherm by Gerhard Rosenberg
- 1978
- Transfer to the first factory in Biggen/D-Attendorf
- 1985
- Completion of factory 1 in Biggen/D-Attendorf
- 1992
- Founding of the branch in Radeberg near D-Dresden
- 1996
- Founding of the metal processing company aquatherm metal, D-Attendorf
- 1998
- Founding of a subsidiary in Carrara/Italy
- 1999
- Completion of the main site in D-Attendorf as one complex (Factories 1+2, Production and Store, Laboratory and Training Centre)
- 2001
- Completion of the extension Factory 2 in D-Attendorf
- 2001
- Opening of the new training centre in D-Radeberg
- 2002
- Completion of the logistics centre in D-Attendorf
- 2003
- Completion of rebuilding and finishing of the training centre in D-Attendorf
- 2003
- 30 year celebration of the company aquatherm
- 2005
- Adding of 2 storeys on the administration building
- 2005/06
- Completion of the 4-storey hall on the premises in Attendorf
- Basement: Store
- Ground floor: Assembly/Packing
- 1st Floor: Laboratory and Technical department
- 2nd Floor: Special manifold construction
- 2008
- Aquisition of the former storehouse of the forwarding agent Kost, which also accomodates the room of the plant maintenance.
- 2009
- Opening of the new expertise centre for technical application.



+7(495) 928-0008

info@agpipe.ru | www.agpipe.ru

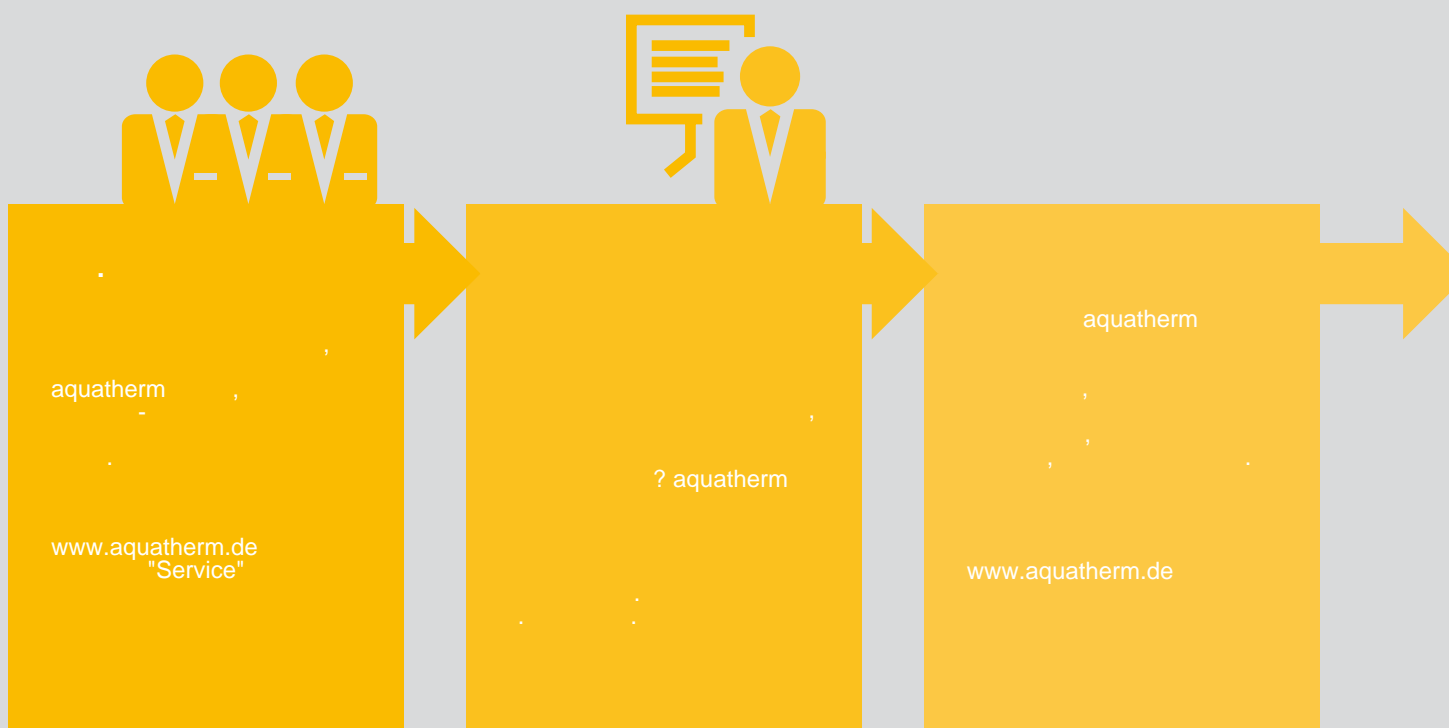

## CERTIFICATIONS IN ACCORDANCE WITH ISO 9001, ISO 14001 & ISO 50001

Since 1996 aquatherm has been meeting the requirements of the certifiable quality management system according to DIN ISO 9001. The 2012 TÜV certificate was extended by the environmental management system according to ISO 14001 and currently by the energy management system according to ISO 50001.

This success is a great contribution and represents a further step to strengthen our competitive position and to meet the high requirements and the responsibility for our customers, partners and the environment.



Management System  
ISO 9001:2008  
ISO 14001:2004  
ISO 50001:2011  
www.tuv.com  
ID 0091005348



### Laboratory

The aquatherm laboratory: from the testing of granulate through to the finished product the customer can be assured of only the highest quality products.



### Software-Service

The aquatherm-software service provides Datanorm-files, an independent graphical program (liNear), and the appropriate training.



### Miscellaneous

Different aquatherm-CD's, prospects, catalogues, poster, leaflets, mailings,calen-dars, a.s.m. are investigated and produced from the internal advertising department. All information regarding the company, the technology, the products, the various trainings and fairs as well as all catalogues in pdf-form can be called and downloaded from the aquatherm - website: [www.aquatherm.de](http://www.aquatherm.de).

# SERVICE

## TABLE OF CONTENTS

<b>Heating pipe</b>	<b>8-11</b>
- New buildings – surface heating / Old buildings – surface heating	8
- General description (System element)	9
- aquatherm orange system-Heating pipes made of polyethylene (PE-RT)	10-11
<b>Manifold technique</b>	<b>12-22</b>
- Heating circuit manifold with flow meter	12
- Heating circuit manifold valves	13
- Accessories for manifold	14-15
- manifold cabinet (concealed installation)	16-17
- Universal manifold cabinet (surface installation)	18
- Pump module	19
- Distribution technique	20-21
<b>Automatic control</b>	<b>23-40</b>
- Automatic control (heating - 230 Volt) Room thermostat & Programmable analogue room thermostat	26
- Automatic control (heating - 230 Volt) connection system	27
- Automatic control (heating - 230 Volt) Control module & Actuator module	28
- Automatic control (heating - 230 Volt) Timer module & Pump module	29
- Automatic control (heating, 24 Volt, wireless)	30-32
- Automatic control (heating and cooling, 24 Volt, wireless)	32-40
<b>Floor Construction</b>	<b>41-76</b>
- DIN-Regulations	42
- Conditions for installation	43
- Examples of design	44
- Impact sound insulation	45-46
- System elements	47
- System element insulation roll	48-50
- System element aluminium foil	51-53
- Accessories system elements	54-55
- aquatherm orange system-System element knob plate F ND 30-2	56-61
- aquatherm orange system-System element TS 25	62-64
- aquatherm orange system-Edge insulation	65
- aquatherm orange system-Expansion joint section	66-67
- Screeds	68
- aquatherm orange system-Screed additive floor mix	69
- aquatherm orange system-Special floor mix	70
- aquatherm orange system-Screed measuring point	71
- Movement joints / Dummy joints	72
- Floor reinforcement / Procedures floor coverings	73
- Floor coverings / Conditions for placing	74
- Heating of screed / Moisture content equilibrium	75
- Starting record of aquatherm-hot water underfloor heating acc. to DIN EN 1264, Part 4	76

## TABLE OF CONTENTS

<b>Planning and Design</b>	<b>77-104</b>
- Regulations / decrees / laws	77
- Calculation	78-79
- Floor surface coverings / symbols / rugs	80
- Length of heating circuit / area of manifold connection / material requirements	81
- Thermal output as per DIN EN 1264	82
- Flow temperature / DIN CERTCO registration	83
- Pressure loss graphs	84
- Graph of heat output	85-90
- Fine control valves	91
- Membrane expansion vessel	92
- Types of Placing	93
- Example of placing: Pipe spacing	94
- Laying of system element TS 25	95-98
- Graph of heat output System element TS 25	99-104
<b>Notes</b>	<b>105-106</b>



aquatherm the surface heating system that started it all is now

## aquatherm orange system

Developed 40 years ago as one of the first surface heating systems, it formed the basis for the company aquatherm. The most traditional system in our lineup changes not only the name but also the colour. In the future, the PE-RT pipes will be produced in this orange colour.

article-no.	old brand name	new branding structure					
		new brand name		colour	structure of pipe	special feature of pipe	material
		company	system				
90020 ... 90030	aquatherm underfloor heating system	aquatherm	orange system	orange	M	OT	PE-RT
90306 ... 90317	aquatherm underfloor heating system	aquatherm	orange system	grey	M	OT	PB

### Fields of application



#### New buildings – surface heating

More than three decades experience in the production and application of underfloor heating systems as well as the continuous development to achieve energy saving and efficient technology, make aquatherm one of the most experienced and globally successful manufacturers of underfloor heating.

The performance of an underfloor heating system is mainly determined by the quality of the installed components:

- > insulation
  - > insulation roll
  - > aluminium foil
  - grid marked sheet
  - > knob plate
  - > element TS 25
- > heating pipe
  - > PE-RT pipe
  - > PB pipe
- > manifold technology
- > control technique

#### Old buildings – surface heating

With the development of the system element TS 25 aquatherm offers an all-purpose heating system for lowest construction thickness in the field of surface heating. It meets all requirements of old and new buildings – especially for refurbishments.

Whether in dry or wet construction, all requirements of an underfloor heating system can be complied with. The extruded system plate with pre-fabricated pipe channels is suitable for every floor plan and each room layout.

#### Advantages

Lowest construction depth (e.g. 50 mm with dry floor, 55 mm with screed, 60 mm with floating floor) due to low plate thickness. The aquatherm system element 25 is the ideal solution for all situations of laying. Interruptions in the progress of construction work is avoided.

# aquatherm orange system



## GENERAL DESCRIPTION (SYSTEM ELEMENT)

### Heating pipes: General description

The operation of a floor heating system is determined by the quality of the heating pipe used.

Typical for the aquatherm orange system-floor heating pipes are the following features:

- › excellent creep strength also at higher temperatures
- › smooth inner pipe surface
- › low friction loss
- › high heat-stabilized
- › corrosion resistance
- › outstanding resistance against chemicals
- › high flexibility
- › high impact rate
- › less sound of flow
- › oxygen-tight due to EVOH-coating acc. to DIN EN 1264

### Processing

aquatherm orange system-heating pipes can be laid without preliminary tempering cold from the roll. For practical reasons, the heating pipes should generally be laid with the aquatherm orange system-pipe hasp.

### Connection technique

Only those pipe joints indicated by the manufacturer should be used for the respective type of pipe.

The aquatherm orange system-connectors and screw connections for manifolds conform to DIN 8076 Part 1, requested in DIN EN 1264.

### Linear expansion

aquatherm orange system-floor heating pipes for wet construction systems are embedded directly into the heating screed.

A change in length resulting from a temperature difference prevented by embedding into the heating screed. The material absorbs tensions so that they are not critical.

### Oxygen-tightness

Manufacturing of the aquatherm orange system-floor heating pipes with an oxygen barrier layer is achieved according to a specially developed extrusion procedure.

Due to the EVOH-coating deposited on the basic pipe as an all-over compound, the pipe reaches an optimum tightness. The adhesive layer between basis pipe and barrier layer results in an adhesion resisting against hardest site conditions.

The oxygen-tight aquatherm orange system-underfloor heating pipes are in accordance with DIN EN 1264.

A system separation by means of a heat exchanger is not necessary as per DIN EN 1264 when using these pipes.

### Heating water additions

In principle only heating water additions with controlled harmlessness regarding the material used by aquatherm can be used. Heating water additions must be expressly released by aquatherm.

The application of corrosion inhibitors is not necessary when using aquatherm orange system-underfloor heating pipes.

### Packing

aquatherm orange system-underfloor heating pipes are packed in site-adapted cardboards impervious to light for protection against mechanical damage or effects from UV-rays.

The pipe bundles have to be stored in the packing until installation.

The pipes are supplied as a ring bundle. Remaining bundles have to be restored in the cardboard.

### External supervision

The supervision contracts necessary in the scope of DIN-CERTCO have been concluded with the SKZ (South German Plastic Centre Würzburg).

### Internal supervision

aquatherm orange system-underfloor heating pipes are self-supervised according to the requirements of the manufacturing works.



## aquatherm orange system HEATING PIPES MADE OF POLYETHYLENE (PE-RT)

Heating pipes made from PE-RT

### Characteristics

aquatherm orange system -underfloor heating pipes made of polyethylene (PE-RT) combined with outside EVOH-barrier acc. to DIN EN 1264/16833/ISO 22391-1,2,5 have an unique molecular structure with controlled side chain distribution, ensuring an excellent environment stress cracking resistance, and a very good long term internal pressure behaviour at high flexibility.

### Designation

AQUATHERM ORANGE SYSTEM FLOOR HEATING PIPE – ART.-No. 90026 – 16 x 2,0 mm – OXYGEN-TIGHT – DIN EN 1264 – DIN 16833 – DATE OF MANUFACTURING / TIME – MACHINE-NO – MTR.-MARKING – MADE IN GERMANY

Moreover, every coil is printed continuously with the length in meters. An instruction leaflet containing the identification data is added to every coil.

### Surplus material

Surplus pipes can be applied with the tested and certified aquatherm grey pipe -connection technique for radiator connection.

aquatherm orange system-Heating pipes made of Polyethylene (PE-RT)		
Art.-No.	Diameter	Length of coil
90020	10 x 1,25 mm	250 m
90024	14 x 2,0 mm	250 m
90034	14 x 2,0 mm	500 m
90026	16 x 2,0 mm	250 m
90036	16 x 2,0 mm	500 m
90027	17 x 2,0 mm	250 m
90037	17 x 2,0 mm	500 m
90028	20 x 2,0 mm	250 m
90030	25 x 2,3 mm	250 m
90038	20 x 2,0 mm	500 m

**Elastic modulus**

The modulus of elasticity as an important parameter of the bending resistance of the pipes is for Polyethylene (PE-RT) at 20° C about 580 N/mm<sup>2</sup>.

Consequently is the smallest admissible

**bending radius 5 x d**

in which d has been determined as outside diameter. For pipes with a diameter of 16 x 2 mm the bending radius will be  $r = 5 \times 16 \text{ mm} = 80 \text{ mm}$ .

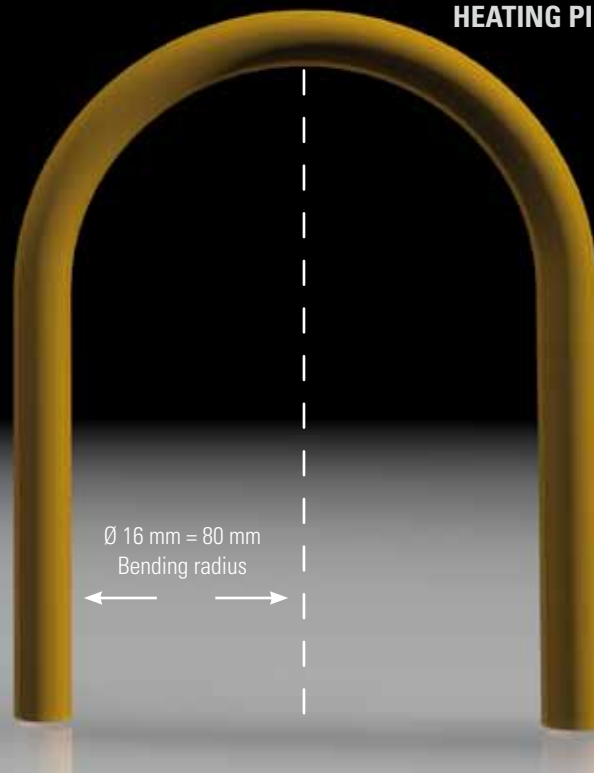
**aquatherm orange system HEATING PIPES MADE OF POLYETHYLENE (PE-RT)****Physical properties of the material PE-RT**

Physical properties	Unit	Test method	Value
Melt-flow index, 190°C / 2.16 kg	g/10 min	ISO 1133	0.7
Melt-flow index, 190°C / 5.16 kg	g/10 min	ISO 1133	2.2
Density	g/cm <sup>3</sup>	ISO 1183	0.933
Vicat softening point	°C	ISO 306 (Method A)	122
Thermal conductivity	W/(mk)	DIN 52612-1	0.4
Linear thermal expansion coefficient	10 <sup>-4</sup> /K	DIN 53752 A (20°C - 70°C)	1.95
Mechanical properties	Unit	Test method	Value
Shore hardness D	%	ISO 868	53
Yield stress	MPa	ISO 527	16.5
Yield tensile elongation	%	ISO 527	13
Tensile strength	MPa	ISO 527	34
Elongation at tear	%	ISO 527	> 800
Flexural modulus	MPa	ISO 178	550
Elastic modulus	MPa	ISO 527	580
Izod impact strength	KJ/m <sup>2</sup> at 23°C KJ/m <sup>2</sup> at - 40°C	ISO 180 ISO 180	no break 8
ESCR Environment Stress Cracking Resistance	h h h	ASTM D 1693-B 10 % 50 % anti-freezer (PEG) 10 % corrosion inhibitor	>8760 (0 Error) >8760 (0 Error)

## HEATING CIRCUIT MANIFOLD WITH FLOW METER

### Characteristics

The aquatherm orange system -manifold is installed for the distribution and adjustment of the volume flow of each single circuit of the surface heating.

The volume is adjusted with a square spanner at the return valve. The regulated rate of flow can be read directly at the flow meter. Thus always the right volume circulating through circuits is guaranteed.

The distributor can be connected selectable from the right as well as from the left side. All commercial Euroconus connector can be connected with the connection nipple G 3/4" for Euro connection. Made from a high-quality brass pipe MS 63 it is equipped on both sides with a male thread 1" for flat packing connection, end pieces with joints, feed valve, and ventilation valve as well as ball valve set 1" with threaded joint.

The manifold is assembled is on a galvanized sound insulated console acc. to DIN 4109.

Please order accessories (Euroconus connectors) separately.

### Special advantages

Flow meter 0-4 l/min with Quickstop stop valve for flow.

Adjustment- and stop valve for return with manual control cap and upper part of a thermostat.

Suitable for all commercial Euroconus connectors.

Extensive accessories.

### Technical data

max. static pressure: PN6	6bar
max. linear heating temperature:	60° C
Feed cock and drain:	R 3/8"
Ventilation valve:	R 3/8"
Heating circuit connection Euroconus:	R 3/4"
<b>Return - manifold (bottom)</b>	
Axial female thread	R 1"
Axial connection nut (flat sealing)	R 1 1/4"
Control valve male thread	M 30 x 1,5
Pressure pin sealing:	double-O-ring
Schließmaß	11,8 mm
Valve lift max.	3,5 mm
Valve opening power	~ 39 N
KVS value	3,0 m³/h
<b>Flow-manifold (top)</b>	
Axial- female thread	R 1"
Axial - connection nut (flat sealing)	R 1 1/4"
with flow indicator „DFA 0-3,5 l/min	R 3/8"



Heating circuit manifold with flow meter

Art.-No.	Circuits	PU
92302	2	1 Pc
92303	3	1 Pc
92304	4	1 Pc
92305	5	1 Pc
92306	6	1 Pc
92307	7	1 Pc
92308	8	1 Pc
92309	9	1 Pc
92310	10	1 Pc
92311	11	1 Pc
92312	12	1 Pc

## HEATING CIRCUIT MANIFOLD VALVES

### Return valves

The integrated return valves enable a problem free exchange of the manual construction protection caps against an electro thermal actuator or manual control caps.

The return valves are provided with stainless steel spindles and double o-ring seal.

### Rate control

The hydraulic compensation of the heating circuits is made at the return control valve according to the calculated values. The mass flow is preset by turning the adjustment spindle left. The actual value at the manifold 92302-92312 is read at the flow meter.

### Packing

The aquatherm orange system -manifolds are supplied in site adapted cartons.

A set of self-adhesive marking plates is added to every manifold. Same can be adhered on the designated fields of the manual control cap or on the actuator.

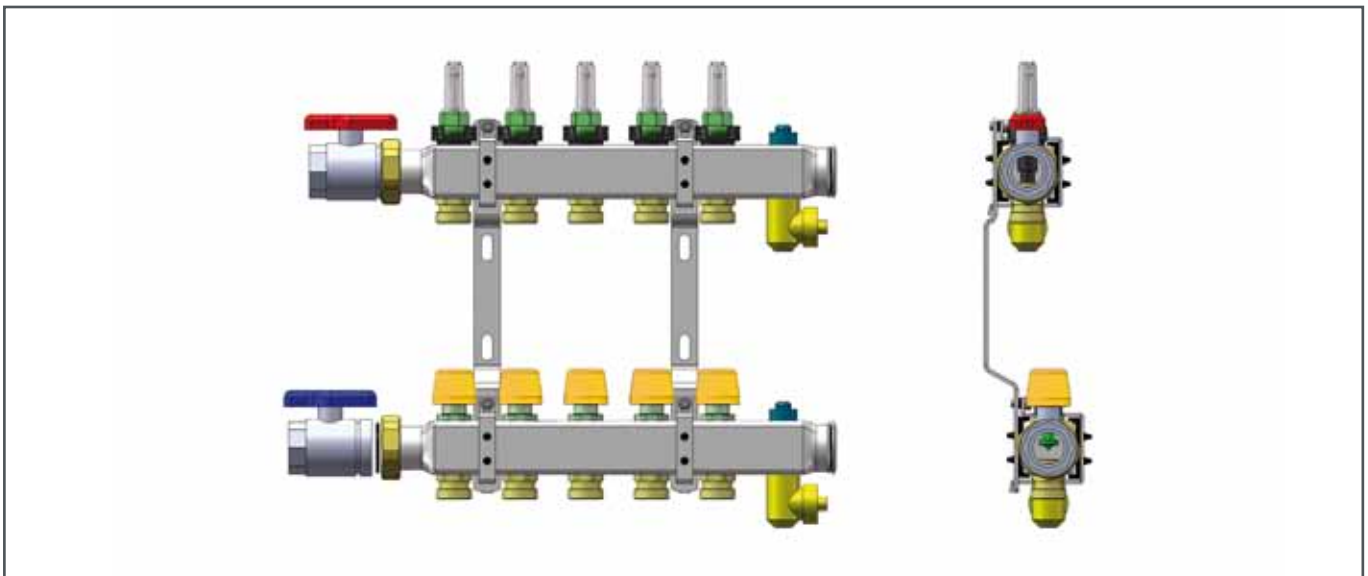

Branches	2	3	4	5	6	7	8	9	10	11	12
Length L in mm	190	240	290	340	390	440	490	540	590	640	690
With ball valve	Length L + 45 mm										
Total length in mm	255	305	355	405	455	505	555	605	655	705	755
Depth maximum	D approx. 95 mm										

## ACCESSORIES FOR MANIFOLD

Following accessories for the aquatherm orange system -manifold are available:

### Euroconus connector

for diameter:

- 10 x 1.25 mm
- 14 x 2.0 mm
- 16 x 2.0 mm
- 17 x 2.0 mm
- 20 x 2.0 mm



Euroconus connector

10 x1,25 mm	Art.-No. 92100
14 x 2,0 mm	Art.-No. 92104
16 x 2,0 mm	Art.-No. 92106
17 x 2,0 mm	Art.-No. 92107
20 x 2,0 mm	Art.-No. 92108

### Connection set

for vertical connection of ball valves



Connection set

Size 1"	Straight Art.-No.: 92320 Angle Art.-No.: 92321
---------	---

**ACCESSORIES FOR MANIFOLD****Universal-flow meter**

add-on kit



Universal-flow meter

Size 1"

**Art.-No. 92323****Manual adjustment cap**

Manual adjustment cap

with +/- scale

**Art.-No. 99109**

## MANIFOLD CABINET ( CONCEALED INSTALLATION)

### aquatherm orange system -Manifold cabinet for concealed installation

#### Characteristics

The aquatherm orange system -universal manifold cabinets for concealed installation are made from hot galvanized sheet steel in lacquered design (RAL 9010).

The manifold cabinet is available in five sizes for manifolds from 2-12 circuits.

#### Special advantages

Universal mounting (C-profile) (3), vertically and horizontally infinitely variable.

Frame (1) with door, infinitely extractable from 110 mm-150 mm, lacquered in white as per RAL 9010.

The lower lining (6), adaptable to the respective height of the finished floor.

The tubular feed through (2) pre-pressed in the lateral parts.

Enabling an reciprocal pipe guidance.

Bases (5), adjustable up to 160 mm of the total height and applicable as fixed points.

The top hat rail (7), for containing the aquatherm orange system-connecting systems.



Manifold cabinet

Art.-No.	Size
93102	Height: 700 - 850 Width: 400 mm Depth: 110 - 150 mm
93104	Height: 700 - 850 mm Width: 550 mm Depth: 110 - 150 mm
93106	Height: 700 - 850 mm Width: 750 mm Depth: 110 - 150 mm
93108	Height: 700 - 850 mm Width: 950 mm Depth: 110 - 150 mm
93110	Height: 700 - 850 mm Width: 1150 mm Depth: 110 - 150 mm

#### Installation dimensions for surface cabinet

Type of cabinet	Size I	Size II	Size III	Size IV	Size V
Height of cabinet inside from / to / mm	700 850	700 850	700 850	700 850	700 850
Width of cabinet inside mm	400	550	750	950	1150
Depth of cabinet inside from / to / mm	110-150				

**MANIFOLD CABINET (CONCEALED INSTALLATION)**

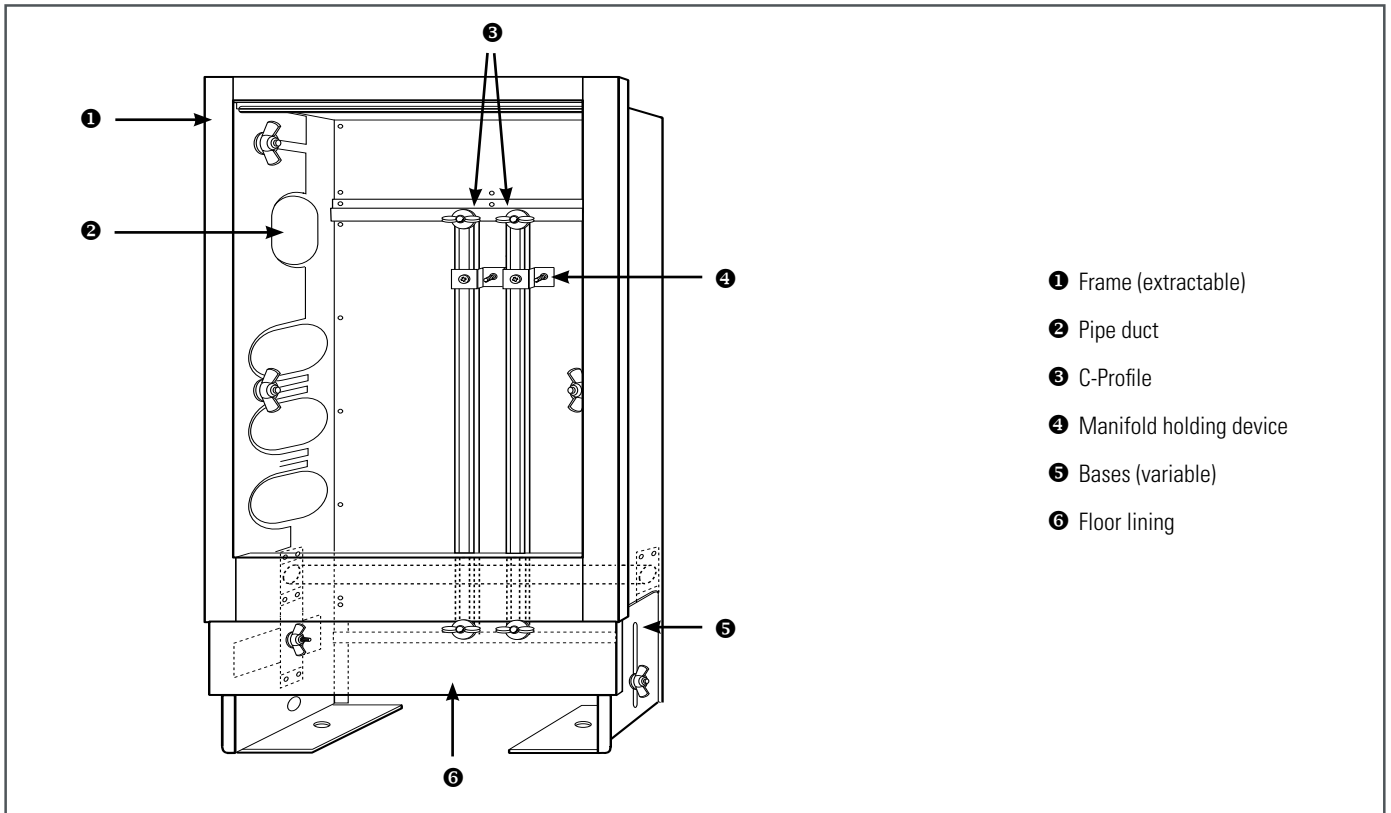

- ❶ Frame (extractable)
- ❷ Pipe duct
- ❸ C-Profile
- ❹ Manifold holding device
- ❺ Bases (variable)
- ❻ Floor lining

**1. Legend**

**2. Construction**

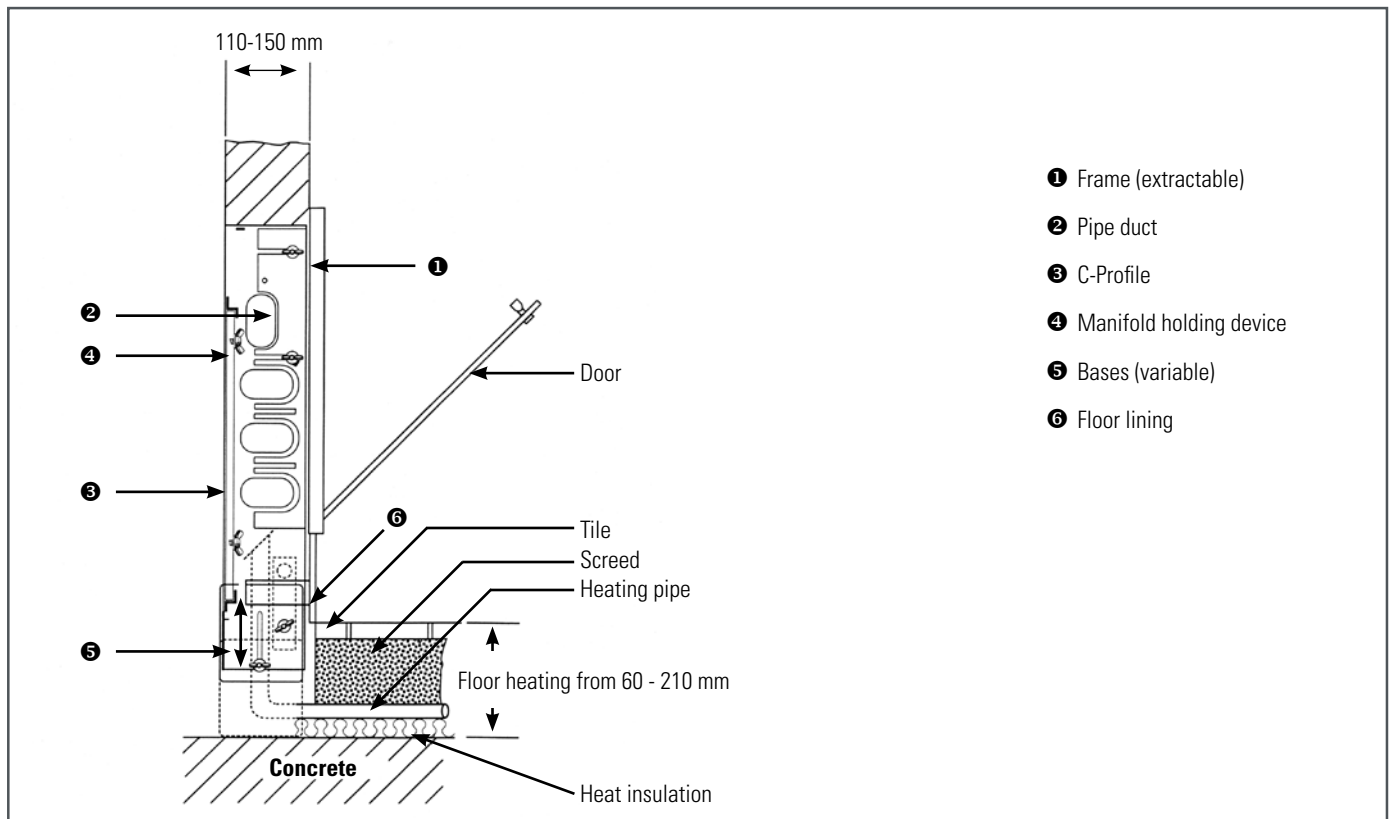

- ❶ Frame (extractable)
- ❷ Pipe duct
- ❸ C-Profile
- ❹ Manifold holding device
- ❺ Bases (variable)
- ❻ Floor lining

## UNIVERSAL MANIFOLD CABINET (SURFACE INSTALLATION)

### aquatherm orange system -Universal manifold cabinet for surface installation

#### Special advantages

If there is no possibility for concealed installation, the aquatherm orange system -heating circuit manifold for surface installation is the alternative:

The casing of hot galvanized sheet steel is supplied in lacquered design (RAL 9010 white) including the back panel.

The back panel is also made of hot galvanized sheet steel (without coat of lacquer) and equipped with a cleat for holding the aquatherm orange system-manifold.



Universal manifold cabinet (surface installation)

#### Installation dimensions for surface cabinet

Art-No.	93112	93114	93116	93118
Type of cabinet	AP I	AP II	AP III	AP IV
Height of cabinet inside mm	730	730	730	730
Width of cabinet outside mm	455	605	805	1005
Depth of cabinet inside mm	128			

#### Manifold installation sizes and range of cabinets

Heating circuit manifold	Length incl. ball valve + manifold end piece	Manifold cabinet size, concealed	Manifold cabinet size, surface	Length with pump module	Manifold cabinet size, concealed	Manifold cabinet size, surface	Length incl. heat meter adapter kit (vertical)	Manifold cabinet size, concealed	Manifold cabinet size, surface
Circuits	mm			mm			mm		
2	255	1	1	400	2	1	330	1	1
3	305	1	1	450	2	2	380	2	1
4	355	2	1	500	2	2	430	2	2
5	405	2	2	550	3	2	480	2	2
6	455	2	2	600	3	3	530	3	2
7	505	3	2	650	3	3	580	3	3
8	555	3	3	700	3	3	630	3	3
9	605	3	2	750	4	4	680	3	3
10	655	3	3	800	4	4	730	4	3
11	705	4	3	850	4	4	780	4	4
12	755	4	3	900	4	4	830	4	4

## PUMP MODULE

### aqualtherm orange system -Pump module

Composed of:

- > Injection-mixing valve for adjustment of flow temperature in the floor circuit
- > Circulating pump
- > Safety temperature limiter
- > Thermometer

### Adjustment / extension

The adjustment and/or extension of an existing radiator system with underfloor heating is

- > safe
- > economic
- > and inexpensive

practicable.

Only one riser of the radiator's temperature level (e.g. 70/50° C) is sufficient.

The rest is adjusted after the installation of the pump module, functioning as a combined adjustment.



Pump module

Art.-No.	Size	PU
92162	up to 80 m <sup>2</sup> heating surface	1 Pc

## DISTRIBUTION TECHNIQUE

### Mode of operation of the pump module

The injection valve is designed as a proportional controller working without parasitic energy. The thermostat, placed in the medium is perpetually charged with the updated flow temperature.

Variations from the set point directly effect a valve lift, so that the hot water quantity injected from the boiler circuit changes.

The injected water quantity intermixes at the input of the circulation pump with the return water from the manifold and keeps the flow temperature constantly in a delineated temperature range.

### Technical data / materials

Maximum permitted operating temperature: 90 °C

Armatures: Brass Ms 58

Maximum permitted operating pressure: 6 bar

Pipe components: Brass Ms 63

Temperature control range: 20 – 45 °C

Springs: stainless steel

Factory setting of flow temperature: 40 °C

O-rings: EPDM

Factory setting of temperature limiter: 55 °C

Flat gaskets: AFM 34 respectively EPDM

Nominal heat capacity: circa 10 kW

Ball valve hubs: PTFE

Flow indicator: 2 - 12 l

Pump capacity: circa 100 W\*

\*regard type label of pump

### Regulation of under floor flow temperature

For maximum power requirement (nominal capacity) the boiler flow temperature must be at least 15 °C higher than the desired flow temperature in the floor circuit!



1

The maximum required admixing quantity of boiler water is regulated with the flow indicator (controlled volume flow in the boiler circuit). The admixing quantity depends on the flow temperature of the boiler circuit.



2

The flow temperature of the mixing valve is regulated at the mode dial (20 - 45° C). The safety temperature limiter switches off the circulation pump when exceeding the adjusted flow temperature (15K over mixing valve temperature).

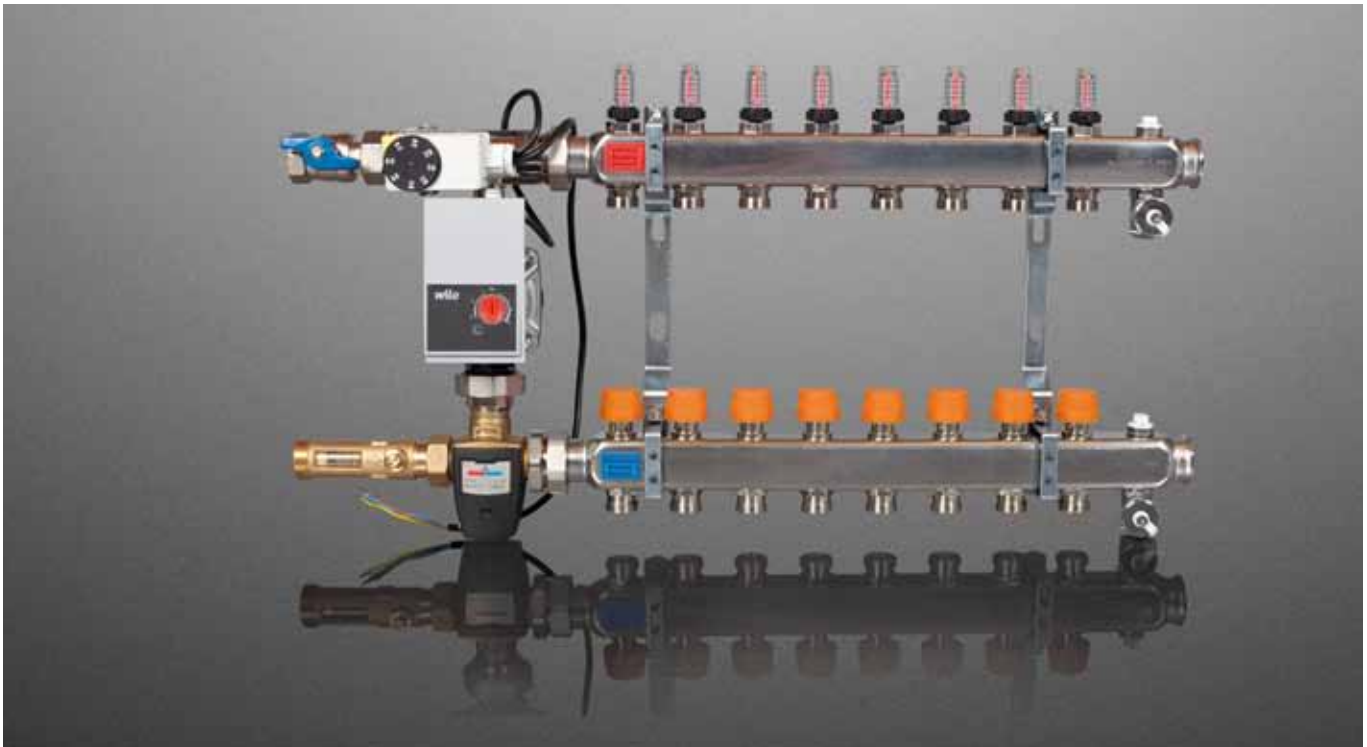
**DISTRIBUTION TECHNIQUE**

**aquaTherm orange system** -Manifold for underfloor heating

**Installation**

The fixed command control can be installed optionally left or right at the aquaTherm orange system heating circuit manifold.

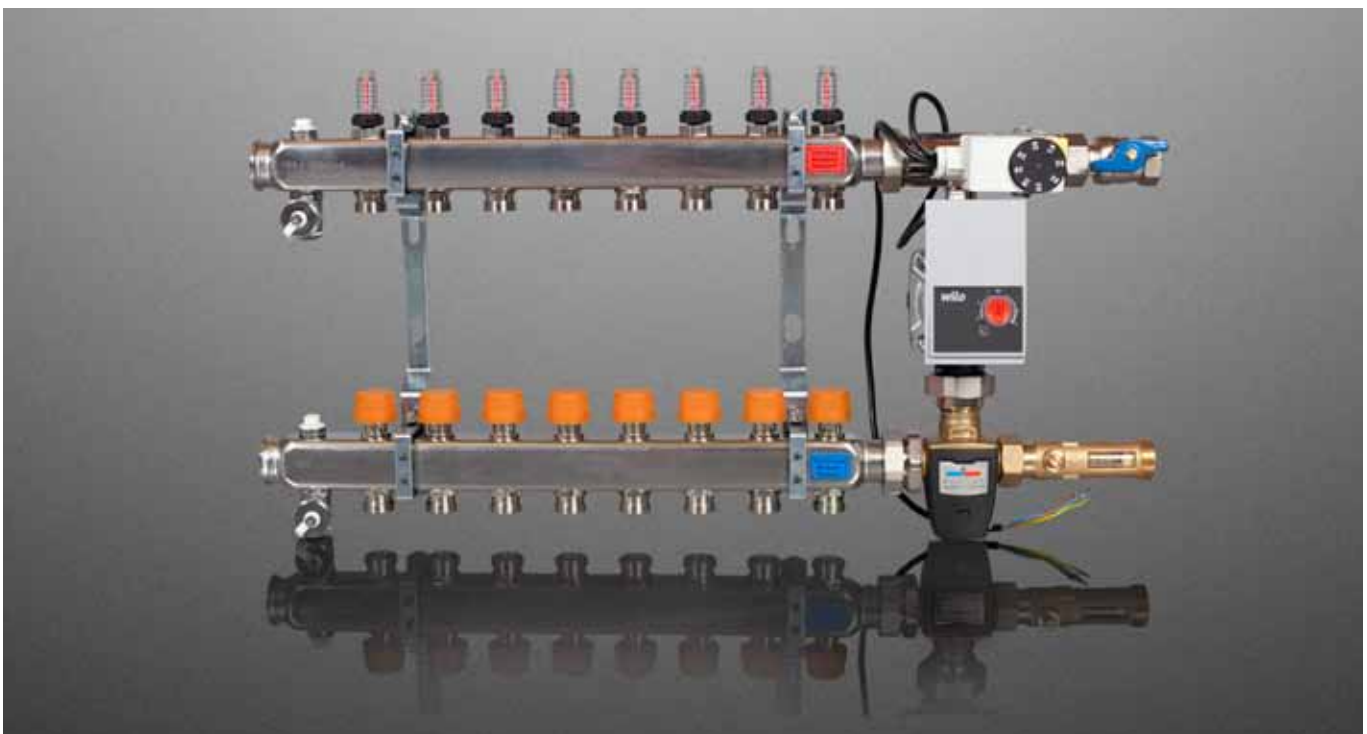

**Function**

The aquatherm orange system -pump module works according to the principle of the mixing controls as set value.

The required flow temperature for the underfloor heating is adjusted with the hand wheel. The necessary water quantity is mixed from the boiler circuit (e.g. 60° C) via the manifold-return to the underfloor heating circuit.

The safety temperature limiter disconnects the circulation pump when exceeding the maximum temperature.

Room thermostats for the control of individual rooms are urgently requested acc. to heating installation regulations.

As far as only one room is equipped with floor heating, the thermostat can be fitted on the circulation pump.

**Advice**

The aquatherm orange system -pump module is only designed for application in a pump hot-water heating installation, constructed according to the following plant scheme.

Different volumen flows and inlet pressures in front of the control valves and pumps possibly require the application of "an element for hydraulical balancing".

Particularly in connections with boilers the application of "elements for hydraulical balancing" is recommended by aquatherm.

(Elements for hydraulical balancing are not part of the aquatherm product range.They must be dimensioned and installed by customers.)

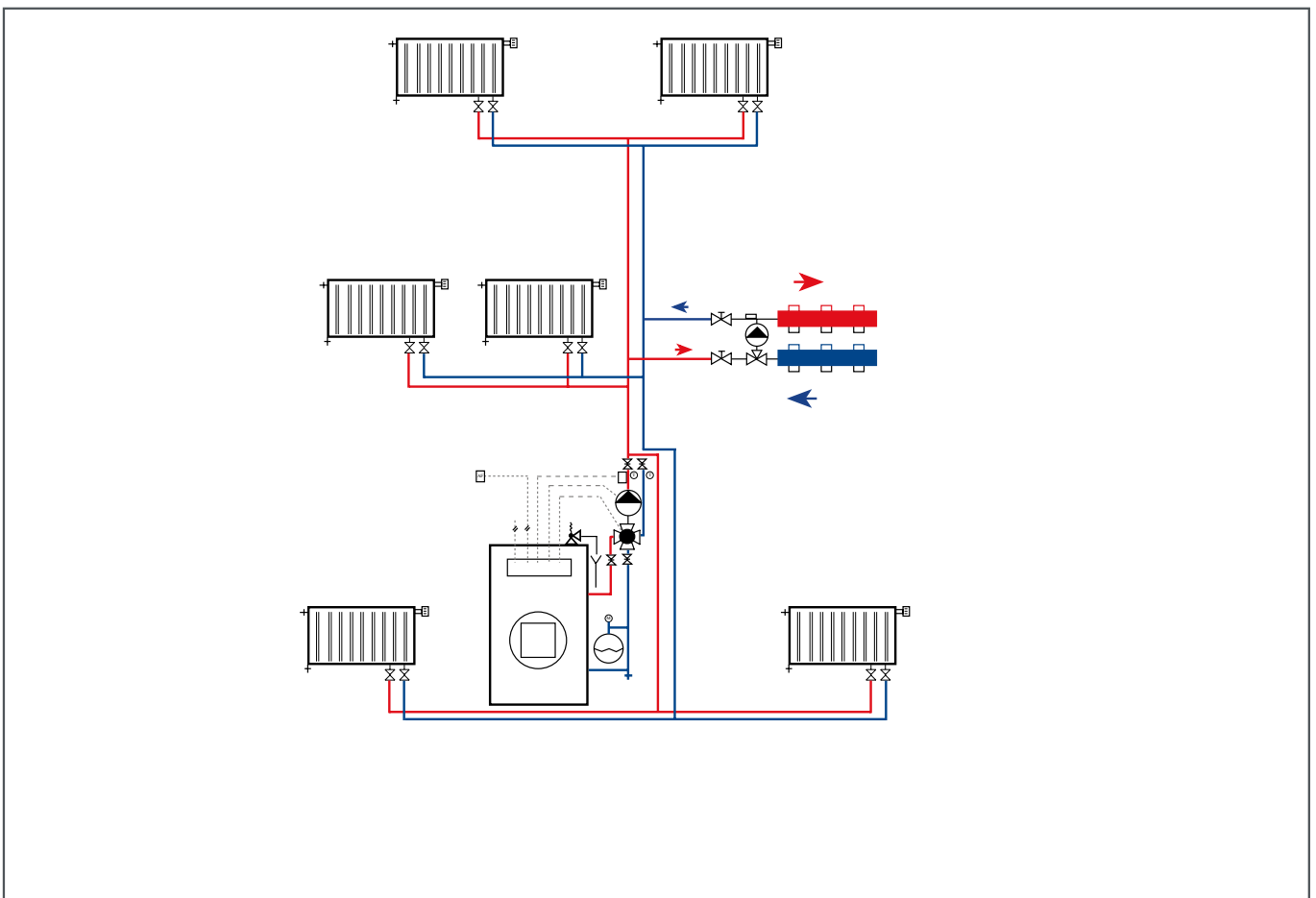



## AUTOMATIC CONTROL

### Requirements

The regulation for energy saving thermal protection and energy saving installation technique for buildings (Decree for Energy Saving – EnEv), stipulates in §14 Distributing Facilities and Hot Water Systems:

“Heating systems must be equipped with automatically operating devices for adjusting the temperature in each room.”

Consequently, every underfloor and wall heating system in residential buildings has to be provided with an individual room control system.

### Pre-control

As defined by the Regulation for Heating Systems the underfloor and wall heating systems must be pre-controlled with outside temperature sensors.

This requirement is met by a sliding operation of the heat generators. In case of combined systems a mixing loop is used so that there is an external temperature control for both control circuits.

### Programmable thermostat (night setback)

A night setback is also useful for underfloor and wall heating systems. Only the setback and heating-up times are advanced accordingly.

Delays of approx. 1.5 - 3.0 hours have to be expected.

### Protection against excess temperature

A protection against excess temperature is a necessity!

Normally contact thermostats are installed disconnecting the circulation pump upon excess of the adjusted temperature or closing the mixing motor.

A gravity brake or a return valve have to be used. The excess temperature protection control should be adjusted to 60° C.

### Circulation pump

The circulation pump has to be selected according to the calculated water quantity and the highest pressure loss.

## AUTOMATIC CONTROL

### aquatherm orange system -Actuator

#### Characteristics

The thermoelectric actuator is a final control element tested by VDE with a spark protection suitable for aquatherm orange system manifold valves.

It has a special electrically heated expansion system and is controlled by a room thermostat. The actuator works without noise and keeps the valve closed in a powerless condition.

The case is heat resistant and made of shock-resistant plastic.

The actuator is provided with a 100 cm connection cable and especially suitable for installation into manifold cabinets due to its compact design.

The actuator shows a uniform opening and closing course. After expiration of a delay time of approx. 2-3 minutes the opening course procedure is effected by the electrically heated expansion system.

The closing procedure is started after interruption of the current supply by cooling down the expansion system.

The actuation - due to the "first open function" - is supplied currentless open. After snap-on installation - in the shell phase - it is possible to heat without electric drive.

When starting (electrical connection) it is ready by the first lifting (power off).

The valve position indicator registers if the valve is open or closed.

The valve is open when the blue field is indicated.  
The indicator is well visible from each position.



Actuator

Art.-No.	Technical data	PU
94102	230 Volt	1 St
94103	24 Volt	1 St

**AUTOMATIC CONTROL (HEATING - 230 VOLT)  
ROOM THERMOSTAT & PROGRAMMABLE  
ANALOGUE ROOM THERMOSTAT**

**aquatherm orange system -Room thermostat**

**Characteristics**

The aquatherm orange system -room thermostat with thermal feedback controls the room temperature in connection with the aquatherm actuator.

The base is suitable for installation to the wall and on switch boxes. It fits to most switch combinations.

**Special advantages**

The selected room temperature keeps constant.

Energy is saved.

Modern convenience.

The control is designed for night set-back by an external signal (Timer). The adjusted temperature is lowered by approx. 4K.



Room thermostat with thermal feedback

Art.-No.	Technical Data	Switching difference	Colour	PU
94107	230 V 50 Hz 10 A	0,5 K	white	1 Pc

**aquatherm orange system -Programmable analogue room thermostat**

**Characteristics**

The aquatherm orange system -programmable analogue room thermostat is equipped with a daily and weekly program disc.

By this rooms are heated resp. lowered at different times and on different days.

This is an ideal alternative for the heating of:

- > Bedrooms and children's rooms
- > Office buildings
- > Doctor's practices
- > Holiday flats

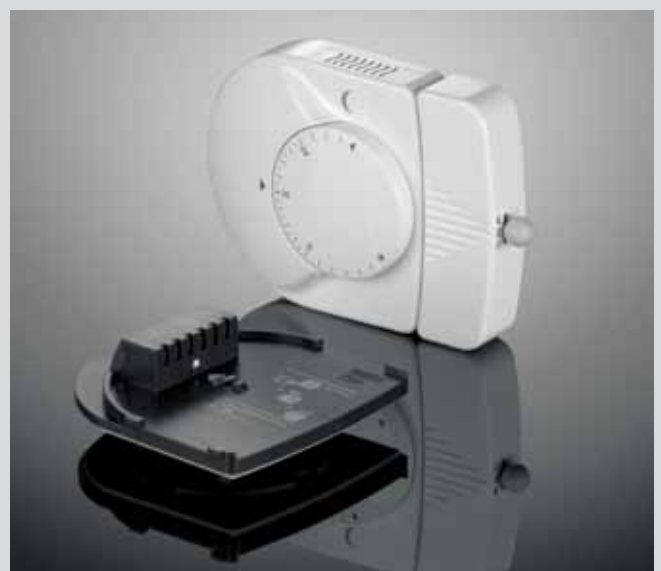

Programmable analogue room thermostat

Art.-No.	Technical Data	Switching difference	Colour	PU
94108	230 V 50 Hz 10 A	0,5 K	white	1 Pc

## AUTOMATIC CONTROL (HEATING - 230 VOLT) CONNECTION SYSTEM

### aquatherm orange system -Connection system 230 Volt

#### Characteristics

With the aquatherm orange system -connection system AB 2006-N 230 V the actuators are wired rapidly with room thermostats, timer thermostats or clock thermostats.

The usual cable tangle in distribution boxes or cable ducts definitely belongs to the past.

Due to the compact design installation on the top hat rail within the aquatherm orange system manifold cabinets is guaranteed.

#### Special advantages

Perfect individual room control with the aquatherm orange system-connection system AB 2006-N 230 V by:

Clear allocation of the connection

Proper cable guiding

Up to 6 room thermostats connectable

Up to 14 actuators connectable

Overload protection, overvoltage protection

Ready to be installed into the aquatherm orange system-manifold cabinet

Plug-in 2 channel digital clock possible

Plug-in extension of control and driving modules possible

Plug-in extension of pump-power module

Installation by screwless connections  
(spring/clamped connection)



Connection system AB 230 V

Art.-No.	Technical Data	Colour	PU
94140	230 V 50 Hz 10 A	grey	1 Pc

## AUTOMATIC CONTROL (HEATING - 230 VOLT)

### CONTROL MODULE & ACTUATOR MODULE

#### Extensions

With an extension module the aquatherm orange system -connection system AB 2006 230 V can be adapted to technical conditions with respect to demands. The extension modules are connected collateral at the integrated cut with the connection system.

The installation of the extension modules is effected according to the installation of the connection systems on the top hat rail in the manifold cabinet.

#### aquatherm orange system -Control module AB RM 2000

Plug-in extension to connect  
2 additional thermostats

Connection options: 2 thermostats, 8 actuators

Function display for switching output of the thermostats

#### Technical data

Connection options: max. 2 thermostats  
max. 4 actuators per thermostat  
Function display: switching output thermostat  
Housing colour: silver grey (RAL 7001)  
Housing colour cover: transparent  
Dimension (mm) H / B / L: 70 / 75 / 88

#### aquatherm orange system -Actuator module AB AM 2000

Plug-in extension to connect additional actuators  
(more than 4 circuits per thermostat)

Connection option: 2 groups in circuits of 4

Jumpers for selecting the heating zone

#### Technical data

Connection options: 4 actuators max. each for  
2 heating zones of the  
connection system  
Function display: jumper for selecting the  
heating zone  
Housing colour: silver grey (RAL 7001)  
Housing colour cover: transparent  
Dimension (mm) H / B / L: 70 / 75 / 88



Control module AB RM 2000 230 Volt

Art.-No.	Technical Data	Colour	PU
94141	2 thermostates 8 actuators	grey	1 Pc



Actuator module AB AM 2000 230 Volt

Art.-No.	Technical Data	Colour	PU
94142	2 groups for each 4 actuators	grey	1 Pc

## AUTOMATIC CONTROL (HEATING - 230 VOLT) TIMER MODULE & PUMP MODULE

### aquatherm orange system -Timer module AB TM 1000

Easy programming of heating periods  
(42 storage locations)

2 heating programs (C1 / C2)

Easy operation by clear text menu guiding

6 languages selectable

Automatic switching between summer- / wintertime

#### Technical data

Power reserve: approx. 120 h  
Function display: switching output thermostat  
Housing colour: silver grey (RAL 7001)  
Housing lid colour: transparent  
Dimension (mm) H / B / L: 46 / 75 / 65

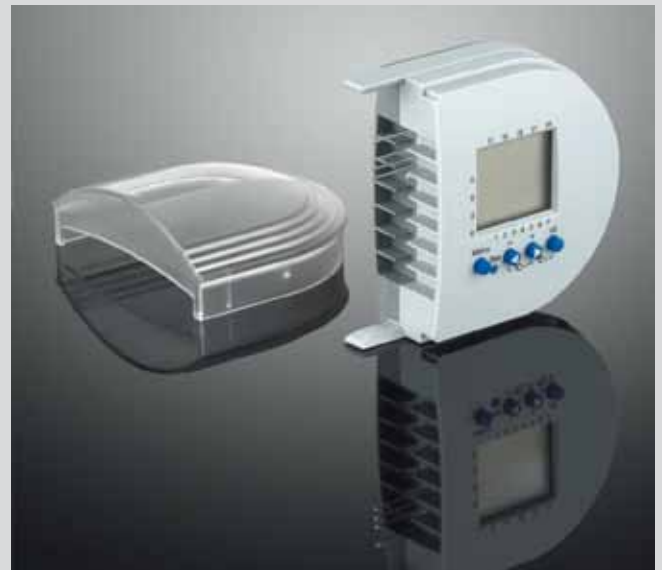

Timer module AB TM 1000

Art.-No.	Technical Data	Colour	PU
94143	2 weekly programs 42 storage locations switching between summer / wintertime	white	1 Pc

### aquatherm orange system -Pump module AB PL 2000

Selection of operation mode pump module resp. power module

Pump module: Automatic shut-down pump,  
Interval mode for summer operation  
Jumper for adjusting the follow-up time 0-15 min.

Power module: load free switching of external units

#### Technical data

Connection options: 2 x NYM 2 x 1.5mm<sup>2</sup> (through wiring) for external units  
Function: Jumper for selecting operation mode (pump module / power module)  
Jumper for adjusting the follow-up time  
Floating contact: Changeover contact  
230 V / 5 A (AC)  
Operating voltage: 230 V, 50/60 Hz  
Housing colour: silver grey (RAL 7001)  
Housing lid colour: transparent  
Dimension (mm) H / B / L: 70 / 75 / 88



Pump module AB PL 2000 230 Volt

Art.-No.	Technical Data	Colour	PU
94144	plug-in extension for switching of circulating pump	grey	1 Pc

**AUTOMATIC CONTROL  
(HEATING, 24 VOLT, WIRELESS)**

**aqualtherm orange system -Connection system wireless 24 Volt**

The aquatherm orange system -connection system wireless is used for installation of underfloor and wall heating in new buildings as well as for refurbishment.

The advantage of this installation is the wireless and individual placement of the room thermostats, as no mortise and plaster works are necessary.

By SET-key button the heating zone at the wireless connection system is linked to the corresponding wireless room thermostat.

The signal codes sent from the control unit grant an exclusive transmission to the assigned channels.

**aqualtherm orange system -Connection system wireless AB 4071-6**

Perfect connection system with six heating zones for room thermostats and actuators

System transfo 24 V plug-in

Automatic temperature setback of two heating programs C1/C2 by timer module as an option

Option of extension by pump module

**Technical data**

Number of thermostats: max. 6  
 Number of actuators: max. 13  
 Function display: operating voltage, safety device, switching output, thermostat  
 Transformer: 230 V, 24 V, 50 / 60 Hz, 50 vA  
 Operating voltage : 24 V, 50/60 Hz  
 Housing colour : silver grey (RAL 7001)  
 Housing lid colour: transparent  
 Dimension (mm) H / B / L: 70 / 75 / 305



Connection system wireless AB 4071-6 24 Volt

Art.-No.	Technical Data	Colour	PU
94148	6 wireless controls 13 actuators	grey	1 Pc

**AUTOMATIC CONTROL**  
**(HEATING, 24 VOLT, WIRELESS)**

**aqualtherm orange system -Connection system wireless AB 4071-12 24 Volt**

Perfect connection system with twelve heating zones for room thermostats and actuators

System transfo 24 V plug-in

Automatic temperature setback of two heating programs C1 / C2 by timer module as an option

Extension module by pump module

**Technical data**

Number of thermostats: max. 12  
 Number of actuators: max. 13  
 Control indicator: operating voltage, safety device, switch exit, thermostat  
 Transformer: 230 V, 24 V, 50 / 60 Hz, 50 vA  
 Operating voltage: 24 V, 50 / 60 Hz  
 Housing colour: silver grey (RAL 7001)  
 Housing lid colour: transparent  
 Dimension (mm) H / B / L: 70 / 75 / 305



Connection system wireless AB 4071-12 24 Volt

Art.-No.	Technical Data	Colour	PU
94149	12 wireless controls 13 actuators	grey	1 Pc

**AUTOMATIC CONTROL**  
**(HEATING, 24 VOLT, WIRELESS)**

**aquatherm orange system-Pump module AB PL 4000 24**

Selection of operation mode pump module resp. power module by jumper

Pump module: automatic pump shutdown, interval mode for summer operation, adjustable follow-up time 0-15 min

Power module: load free switching of external units

- Number of thermostats: 2 x NYM 2 x 1.5 mm<sup>2</sup> (through-wiring) for external units
- Functions: Jumper for selecting heating zones / operating mode (pump module, power module) Jumper for adjusting the follow-up time 0-15 min.
- Floating contact: changeover contact 230 V / 5 A (AC)
- Operating voltage: 24 V, 50 / 60 Hz
- Housing colour: silver grey
- Housing lid colour: transparent
- Dimension (mm) H / B / L: 70 / 75 / 88



Pump module AB PL 4000 24 Volt

Art.-No.	Technical Data	Colour	PU
94150	plug-in extension for switching of circulating pump	grey	1 Pc

**aquatherm orange system-Room thermostate wireless AR-4070 KF**

The installation of the wireless room thermostats is simple and flexible due to its assembly without cables.

Via SET-button the heating zone of the wireless connection system assigns the corresponding wireless room thermostat.

Temperature control using wireless transmission

Rotary temperature control knob with degree "soft clicks"

Limitation of set temperature range

Selection of operating mode (ON / OFF / AUTOMATIC)

Operating voltage more than 2 x Mignon (AA) Alkaline-Megan-Cells, approx. 5 years lifetime

Transmitter frequency 868 MHz, radiated power approx. 1 mW. Signal coverage in buildings approx. 25 m.

Automatic temperature setback (4K)

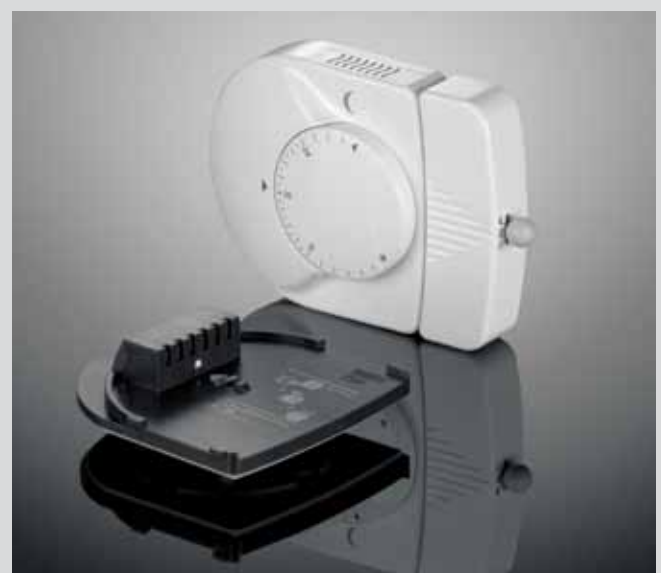

Room thermostate wireless AR-4070 KF

Art.-No.	Technical Data	Colour	PU
94151	temperature area 10 - 28°C	white	1 Pc

## AUTOMATIC CONTROL (HEATING AND COOLING – 230 VOLT)

### aquatherm orange system -Connection system 230 Volt

With the aquatherm orange system -connection system ASV 6 the actuators are rapidly wired with the room thermostats.

#### Special advantages

- > clear allocation of the connection
- > proper cable guiding
- > up to 6 room thermostats (Art.-No. 94172) connectable
- > overload protection by exchangeable microfuse
- > overvoltage protection by varistor
- > input: C / O= change over (heating / cooling)
- > input: N / R= normal / reduced operation
- > output: 24 V AC; 5 vA



Connection-system ASV 6

Art.-No.	Technical Data	Colour	PU
94170	6 room thermostats, 12 actuators	white	1 Pc

**AUTOMATIC CONTROL  
(HEATING AND COOLING – 230 VOLT)**

**aquatherm orange system -Room thermostat  
for heating and cooling NRT 210 (2-pipe system)**

**Technical data**

Temperature range: 10-30° C  
 Differential gap: 0.5 K  
 Breaking capacity: 5 (2) A; 1 relay  
 Dimension (mm) H / B / L: 76 / 76 / 35



Room thermostat for heating and cooling NRT 210

Art.-No.	Technical Data	Colour	PU
94172	temperature area: 10 - 30 °C	white	1 Pc

**aquatherm orange system -Room thermostat  
for heating and cooling NRT 220 (4-pipe system)**

**Technical data**

Temperature range: 10-30° C  
 Differential gap: 0.5 K  
 Breaking capacity: 2 (1,2) A; 2 relays  
 Dead zone: 1.5 K extended 7 K  
 Dimension (mm) H / B / L: 76 / 76 / 35



Room thermostat for heating and cooling NRT 220

Art.-No.	Technical Data	Colour	PU
94174	temperature area: 10 - 30°C	white	1 Pc

## AUTOMATIC CONTROL

### (HEATING AND COOLING – 24 VOLT)

#### aquatherm orange system -Connection system 24 Volt

##### Characteristics

With the aquatherm orange system -connection system AB 4001-6 24V the actuators are wired rapidly with room thermostats, timer thermostats or clock thermostats.

The usual cable tangle in distribution boxes or cable ducts definitely belongs to the past.

Due to the compact design installation on the top hat rail within the aquatherm orange system-manifold cabinets is guaranteed.

##### Special advantages

Perfect individual room control with the aquatherm orange system-connection system AB 4001-6 24 V by:

- Clear allocation of the connection
- Proper cable guiding
- Up to 6 room thermostats connectable
- Up to 14 actuators connectable
- Overload protection, overvoltage protection
- Ready to be installed into the aquatherm orange system-manifold cabinet
- Plug-in 2 channel digital clock possible
- Plug-in extension of control and driving modules possible
- Plug-in extension of pump-power module
- Installation by screwless connections (spring / clamped connection)



Connection system AB 4001-6

Art.-No.	Technical Data	Colour	PU
94152	230 V/24 V 50 Hz -50 vA	grey	1 Pc

## AUTOMATIC CONTROL (HEATING AND COOLING – 24 VOLT)

### Extensions

With an extension module the aquatherm orange system -connection system AB 4001-6 24 V can be adapted to technical conditions with respect to demands. The extension modules are connected collateral at the integrated cut with the connection system.

The installation of the extension modules is effected according to the installation of the connection systems on the top hat rail in the manifold cabinet.

### aquatherm orange system -Control module AB RM 4000 24 Volt

Plug-in extension to connect 2 additional thermostats

Connection options : 2 thermostats, 8 actuators

Function display for switching output of the thermostats

### Technical data

Connection options: max. 2 thermostats  
max. 4 actuators  
per thermostat  
Function display: switching output thermostat  
Housing colour: silver grey (RAL 7001)  
Housing colour cover: transparent  
Dimension (mm) H / B / L: 70 / 75 / 88

### aquatherm orange system -Actuator module AB AM 4000 24 Volt

Plug-in extension to connect additional actuators  
(more than 4 circuits per thermostat)

Connection option: 2 groups in circuits of 4

Jumpers for selecting the heating zone

### Technical data

Connection options: 4 actuators max. each for  
2 heating zones of the  
connection system  
Function display: jumper for selecting the  
heating zone  
Housing colour: silver grey (RAL 7001)  
Housing colour cover: transparent  
Dimension (mm) H / B / L: 70 / 75 / 88



Control module AB RM 4000 24 Volt

Art.-No.	Technical Data	Colour	PU
94131	2 thermostates 8 actuators	grey	1 Pc



Actuator module AB AM 4000 24 Volt

Art.-No.	Technical Data	Colour	PU
94132	2 groups for each 4 actuators	grey	1 Pc

**AUTOMATIC CONTROL**  
**(HEATING AND COOLING – 24 VOLT)**

**aquatherm orange system -Timer module AB TM 1000 N**

Easy programming of heating periods  
 (42 storage locations)

2 heating programs (C1 / C2)

Easy operation by clear text menu guiding

6 languages selectable

Automatic switching between summer- / wintertime

**Technical data**

Power reserve: approx. 120 h  
 Function display: switching output thermostat  
 Housing colour: silver grey (RAL 7001)  
 Housing lid colour: transparent  
 Dimension (mm) H / B / L: 46 / 75 / 65



Timer module AB TM 1000 N

Art.-No.	Technical Data	Colour	PU
94143	2 weekly programs 42 storage locations switching between summer / wintertime	grey	1 Pc

**aquatherm orange system -Pump module AB PL 4000 24 Volt**

Selection of operation mode pump module resp.  
 power module

Pump module: Automatic shut-down pump  
 Interval mode for summer operation  
 Jumper for adjusting the follow-up time 0-15 min

Power module: load free switching of external units

**Technical data**

Connection options: 2 x NYM 2 x 1.5mm<sup>2</sup> (through  
 wiring) for external units  
 Function: Jumper for selecting  
 operation mode  
 (pump module / power module)  
 Jumper for adjusting the  
 follow-up time  
 Floating contact: Changeover contact  
 230 V / 5 A (AC)  
 Operating voltage: 24 V, 50/60 Hz  
 Housing colour: silver grey (RAL 7001)  
 Housing lid colour: transparent  
 Dimension (mm) H / B / L: 70 / 75 / 88



Pump module AB PL 4000 24 Volt

Art.-No.	Technical Data	Colour	PU
94150	plug-in extension for switching of circulating pump	grey	1 Pc

**AUTOMATIC CONTROL**  
**(HEATING AND COOLING – 24 VOLT)**

**aquatherm orange system -Heating-cooling module**  
**AB HK 4000 24 Volt**

The plug-in extension of the connection system automatically initiates the change-over of all connected room thermostats into the cooling mode by external potential-free contact or manually.

**Technical data**

Function display: mode heating / cooling  
 Input: potential-free contact  
 Operating voltage: 24 V, 50 / 60 Hz  
 Housing colour: silver grey (RAL 7001)  
 Housing lid colour: transparent  
 Dimension (mm) H / B / L: 46 / 75 / 65



Heating-cooling module AB HK 4000 24 Volt

Art.-No.	Technical Data	Colour	PU
94153	Plug-in extension for changeover from heating to cooling	grey	1 Pc

**aquatherm orange system -Room thermostat for heating and cooling in one system 24 Volt**

**Technical data**

Temperature range: 10-30° C  
 Operating voltage: 24 V, 50-60 Hz  
 Type of protection: IP 20  
 Switching hysteresis: 1 K  
 switching capacity: 4A; 24 V  
 Outlets: 1 x heating  
 1 x cooling  
 Features: 2 x relais  
 Luminous diode multi-colour: red= heating operation  
 blue = cooling operation  
 yellow = cooling operation off, due to danger of condensation

The room thermostate has a concealed case fitting to the switch box acc. to DIN 49073.



Roomthermostat AR 4010K; heating and cooling 24 Volt

Art.-No.	Technical Data	Colour	PU
94034	Temperature range: 10 - 30 °C	white	1 Pc

**AUTOMATIC CONTROL  
(HEATING AND COOLING – 24 VOLT)**

**aquatherm orange system -dew point converter**

**Technical Data**

The dew point converter detects the danger of condensation in one or more of the connected dew point feelers.

By a potential free relay contact the cooling unit or a mixer/valve can be closed. Thus the temperature of the cooling medium is regulated in a way that no condensation can develop. The switch signal is activated, when 80 % relative humidity is exceeded.

Up to 5 dew point feeler can be connected in parallel.



Dew point converter, 24 volt

Art.-No.	Technical Data	PU
94035	Dew point converter for switching off the cooling unit or for closing of mixer/valve by potential free relay contact.	1 Pc

**aquatherm orange system -dew point feeler**

The aquatherm-dew point feeler consists of a flexible foil with an integrated conductive path. The foil is fixed at the cold water flow and must be exposed to the ambient air.

**Technical Data**

Length: 98 mm  
 Width: 27 mm  
 Feed cable: 10 mtr LIYY 2 x 0,5 mm

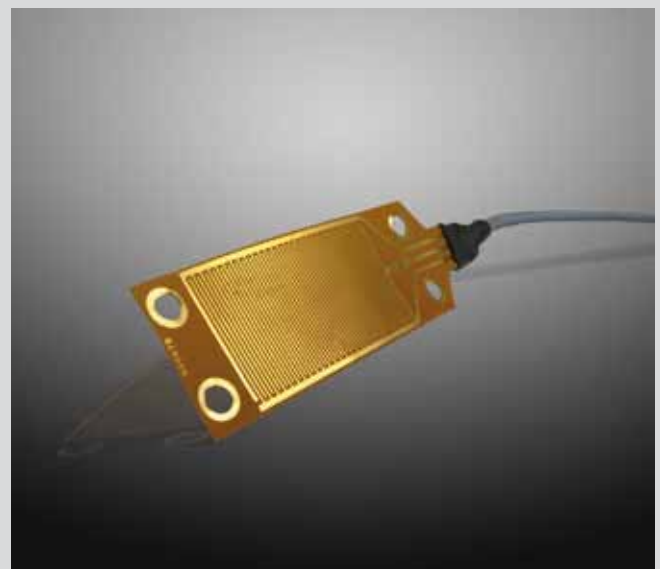

Dew point feeler, 24 Volt

Art.-No.	Technical Data	PU
94036	humidity sensor with flexible foil length of supply = 10 m (LIYY 2 x 0,15 mm)	1 Pc

**AUTOMATIC CONTROL  
(HEATING AND COOLING – 24 VOLT)  
AUTOMATIC CONTROL  
(ZONE CONTROL EDGE / STRAIGHT)**

**aquatherm orange system** -Room thermostat for heating (24 Volt)

**Technical data**

Temperature range: 10-28° C  
Operating voltage: 24 V, 50/60 Hz  
Switching current: 1.0 A  
Switching capacity: max. 5 actuators 24 V  
Dimension (mm) H / B / L: 80 / 84 / 27

Automatical temperature lowering (4K) by external breaker signal.



Room thermostat for heating 24 Volt

Art.-No.	Technical Data	Colour	PU
94156	Temperature range: 10-28 °C	white	1 Pc

## FLOOR CONSTRUCTION

## DIN-REGULATIONS

### DIN-Regulations

European minimum insulation acc. to EN 1264-4

After introduction of the Energy Saving Regulation (EnEV) on 01.02.2002 a minimum insulation acc. to EN 1264, Part 4 for floor heating systems is valid for all European countries to the contract.

This standard is effective for floor heating systems in residential buildings, in offices and all buildings similar to residential buildings.

### Energy Saving Regulation EnEV

The Energy Saving Regulation EnEV is in force since 01.02.2002.

For construction applications from 01.02.2002 the EnEV must be applied.

The EnEV is only effective for the Federal Republic of Germany. The minimum insulation acc. to technical rules is required herein.

### The following has to be considered for hot-water underfloor heating systems:

flat separation ceilings against unheated rooms  
= requirements acc. to DIN 4108-4

ceilings against unheated rooms  
= requirements acc. to EnEV

ceilings against ground  
= requirements acc. to EnEV

ceilings against outside air  
= requirements acc. to EnEV

Designs with better insulation than required in DIN 4108-4 or in EnEV should be passed to the planner.

	Heated room below	Unheated room or in distances heated room below or direkt on the ground*	Outdoor temperature below		
			Dimensioning outdoor temperature $T_d \geq 0 \text{ }^\circ\text{C}$	Dimensioning outdoor temperature $T_d$ $0 \text{ }^\circ\text{C} > T_d \geq -5 \text{ }^\circ\text{C}$	Dimensioning outdoor temperature $T_d$ $-5 \text{ }^\circ\text{C} > T_d \geq -15 \text{ }^\circ\text{C}$
Thermal resistance ( $\text{m}^2\text{K}/\text{W}$ )	0,75	1,25	1,25	1,50	2,00

\* If the ground water level is  $< 5 \text{ m}$ , this value should be increased.

### The following regulations and DIN-standards also have to be considered exactly.

(Individual regional regulations are disregarded)

#### General standards and regulations:

- DIN 4102 Behaviour of materials and components in fire
- DIN 4108 Thermal insulation in high buildings
- DIN 4109 Sound insulation in high buildings
- DIN 18195 Buildings sealing
- DIN 18202 Dimensional tolerance in high buildings
- DIN 18336 Sealing against pressing water
- DIN 18337 Sealing against non-pressing water

### VOB Contract procedure for building works, part C

- DIN 18352 Tiles and plate works
- DIN 18353 Screed works
- DIN 18356 Parquetry
- DIN 18365 Floor covering works

#### Components of the floor construction

- DIN EN 13813 Screed mortar and screed compounds
- DIN 18560 Screed in building works

## CONDITIONS FOR INSTALLATION

The conditions for placing on site have to be checked prior to starting the installation.

The following conditions are required for a perfect installation:

1. Walls and ceilings have to be plastered, tiled or prepared in such a way that there is no dirt accumulation after placing of the underfloor heating.
2. Windows and outside doors have to be installed.  
(Screed has to be protected against weather!)
3. For rooms adjacent to the ground a humidity sealing as per DIN has to be installed. If there is no sealing, the works supervisor must be informed in order to clarify the conditions prior to the start of installation.

In case of buildings sealing made of bituminous material or other plasticizer separating materials an intermediate foil has to be laid before placing the polystyrene heat impact sound insulation. On using polyurethane HR foam boards the intermediate foil is not necessary.

4. The grounding may not have coarse unevenness, point bumps, different levels or insufficient solid surfaces. The tolerance of flatness must correspond to the requirements of DIN 18202 "Tolerances in high buildings" (flatness tolerances for surfaces of covers and walls).

The requirements of DIN 18560 as well as DIN EN 1264 have to be considered. The rough concrete cover has to be cleaned by the customer.

5. The aquatherm orange system-manifolds are installed and tested under pressure.
6. Connecting supplies for individual room control are planned and laid.

EXAMPLES OF DESIGN

Example for floor construction with building sealing by customer acc. to DIN 18195 with aquatherm orange system-system element insulation roll 35-3.

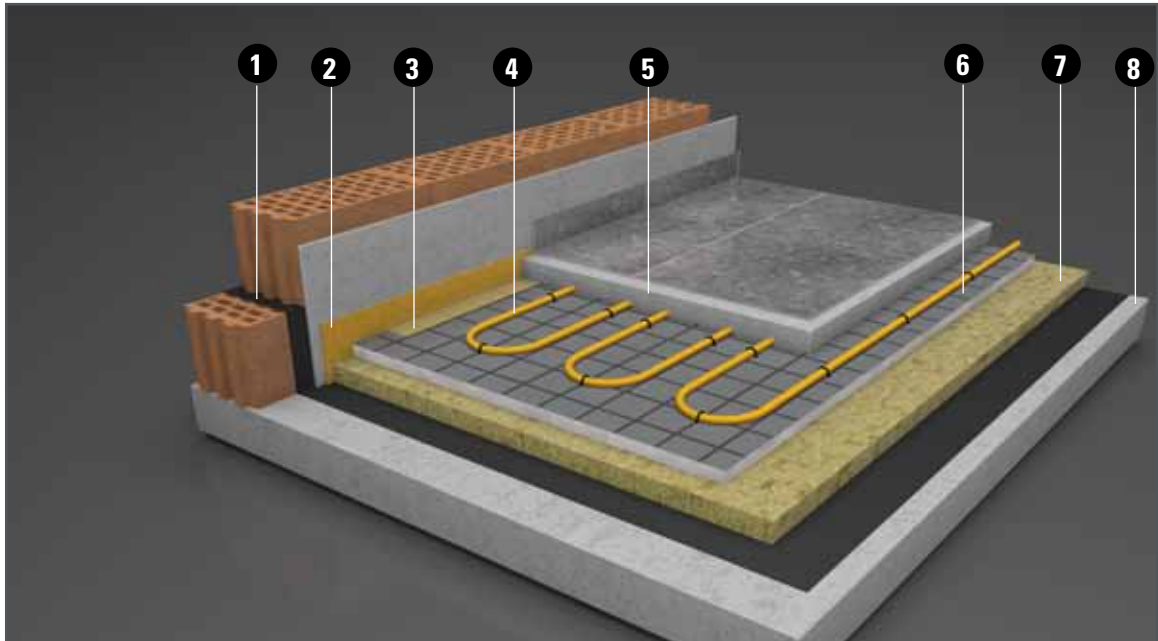

- |   |  |
|---|--|
| <b>1</b> Waterproofing of buildings DIN 18195     | <b>5</b> Cement screed                   |
| <b>2</b> Edge insulation (min. 8mm thickness)     | <b>6</b> Insulation roll 35-3 resp. 30-2 |
| <b>3</b> Welded-on PE foil of the edge insulation | <b>7</b> Additional insulation           |
| <b>4</b> Heating pipe                             | <b>8</b> Concrete                        |

Example for floor construction with building sealing by customer acc. to DIN 18195 and additional sealing against surface water (baths, shower, etc.) acc. to DIN 19337 (sealing above the heating surface), with aquatherm orange system-system element knob plate F ND 35-3.

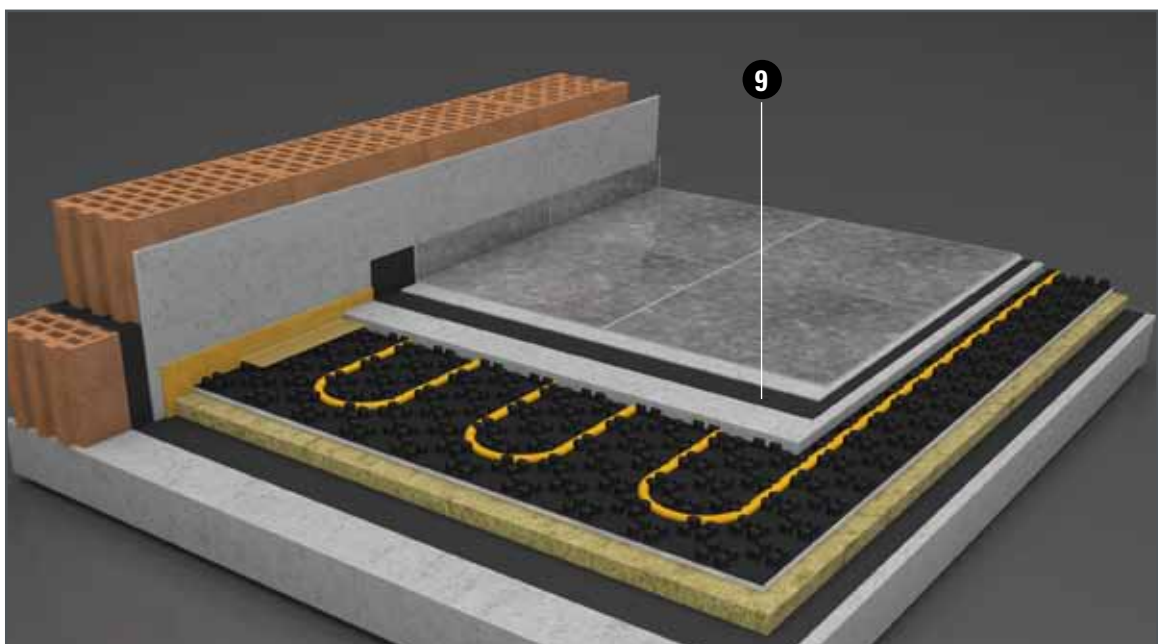

- |   |
|---|
| <b>9</b> Sealing against surface water according to DIN 18337 |
|---|

## IMPACT SOUND INSULATION

Since the publishing of DIN 4109 in November 1989, requirements and demands for sound insulation have been regulated. This standard aims to protect people against unacceptable nuisances of sound transmission.

In the field of underfloor heating the impact sound insulation concerns planners, trade and building-owners.

Following components have to be considered:

- > **Rough cement floor**
- > **Impact sound insulation**
- > **Screed**
- > **Edge insulation**

(soft elastic floor coverings may not be considered due to the possible interchangeability).

The calculation procedure of DIN 4109 uses the following terms:

<b><math>L_n, W, eq, R</math></b>	=	<b>equivalent evaluated standard impact sound insulating level</b>
<b><math>\Delta L_w, R</math></b>	=	<b>impact sound improvement dimension</b>
<b><math>L'_{n, W}</math></b>	=	<b>evaluated standard impact sound insulating level</b>

The equivalent standard impact sound insulation level considers the mass of the rough cover in relation to the surface (solid cover).  
(DIN 4109, supplement 1, table 16)

With the impact sound improvement dimension the impact sound insulating effect of the cover coat (insulating material) is considered.  
(DIN 4109, supplement 1, table 17)

The evaluated standard impact sound insulating level is the requirement of DIN 4109, supplement 2, table 2 + 3.

It is distinguished according to the following criteria:

### Criteria A:

Sound transmission from an adjoining living or working area:

- > minimum demands = 53 dB
- > proposal for increased sound protection = 46 dB

### Criteria B:

Sound transmission from own living or working area:

- > minimum demands = 56 dB
- > proposal for increased sound protection = 46 dB

On calculating the evaluated standard impact sound insulating level  $L_n, w, R$ , a correction value of 2 dB has to be considered.

## IMPACT SOUND INSULATION

The required or requested impact sound insulating level can be calculated with the following calculation scheme:

$L_{n,w,eq}$	+	dB
$\Delta L_{w,R}$	-	dB
$L'_{n,W,R}$	=	dB
Correction value	+	dB
<hr/>		
$L'_{n,w}$	=	dB

In fact an increased sound protection with a requirement of 46 dB normally can only be fulfilled by soft elastic cover coats.

When using hard (ceramic) covers this value can only be reached by the installation of a sound insulating sublayer.

The planner is responsible for a sufficient impact sound insulation.

Solid cover	Thickness (cm)	12	14	16	18	20
Reinforced concrete plain sheet volume weight = 2300 kg/m <sup>3</sup>	Mass in relation to the surface (kg/m <sup>2</sup> )	276	322	368	414	460
	$L_{n,w,eq,R}$ (equivalent evaluated standard impact sound level)	79	77	75	73	71

Evaluated standard impact sound level  $L_{n,w,R}$  in dB as per DIN 4109 depending on the dynamic rigidity of the insulation material as per DIN 18165 (MN/m<sup>3</sup>)

System elements as footfall sound level					
Knob plate F ND 30-2 s' m 20, ( $\Delta L_{w,R} = 28$ )	53	51	49	47	45
insulation roll 35-3 s' m 10, ( $\Delta L_{w,R} = 30$ )	51	49	47	45	43
insulation roll 30-2 s' m 20, ( $\Delta L_{w,R} = 28$ )	53	51	49	47	45

Cover coat / floating floor	$\Delta L_{w,R} (VM_R)$ dB	
	With a hard cover coat	with a soft elastic cover coat <sup>1)</sup> $\Delta L_{w,R}$ m 20 dB ( $VM_R$ m 20 dB)
Floor pavements as per DIN 18560 part 2 <sup>2)</sup> with a mass in relation to the surface of $\leq 70$ kg/m <sup>2</sup> on insulation layers of insulation material as per DIN 18165 part 2 with a dynamic rigidity „s“ of maximum:		
50 MN/m <sup>3</sup>	22	23
40 MN/m <sup>3</sup>	24	25
30 MN/m <sup>3</sup>	26	27
20 MN/m <sup>3</sup>	28	30
15 MN/m <sup>3</sup>	29	33
10 MN/m <sup>3</sup>	30	34

1) Due to the possible interchangeability of the soft elastic cover coats as per tabel 18, being subject to wear and to special requests of the residents, same may not be taken into account for the proof of demands as per DIN 4109.

2) DIN 18560 part 2, Screed in the building trade screed and heating screed on insulation layers.

## SYSTEM ELEMENTS

## SYSTEM ELEMENT INSULATION ROLL 35-3 AND 30-2

### Insulation roll

#### Characteristics

The aquatherm orange system-system element insulation roll 35-3 is an effective heat-impact sound insulation system.

Cuts at the rear of the polystyrene insulation roll allow a homogenous close insulation layer after laying.

The cloth-lined covering layer on the upper surface provides a good fixing of the heating pipes by means of pipe clips.

With this type of placing, known as tacker-technique, quick installation times can be achieved. The insulation roll is available in 10.000 mm length and 1.000 mm width.

#### Special advantages

Variable laying distances

Exact placing of heating pipe - horizontal and vertical - acc. to DIN EN 1264

No cuttings

Imprinted screen for placing (Division: 50 mm rising)



Insulation roll

Technical data insulation roll	
35-3	30-2
Thermal resistance: 0,75 m <sup>2</sup> K/W	Thermal resistance: 0,75 m <sup>2</sup> K/W
Dynamic rigidity: 10 MN/m <sup>3</sup>	Dynamic rigidity: 20 MN/m <sup>3</sup>
Impact sound improv. dimension: 30 db	Impact sound improv. dimension: 28 db
max. carrying capacity: 4,0 kN/m <sup>2</sup>	max. carrying capacity: 5,0 kN/m <sup>2</sup>
Insulation size: 35 mm	Insulation size: 30 mm
Art-No. 91035	Art-No. 91033

Combined with additional insulations the requirements acc. to EnEV can be met.

## SYSTEM ELEMENT INSULATION ROLL

Floor detail for **heated rooms** =  
Requirements acc. to DIN 1264-4

## FLOOR CONSTRUCTION

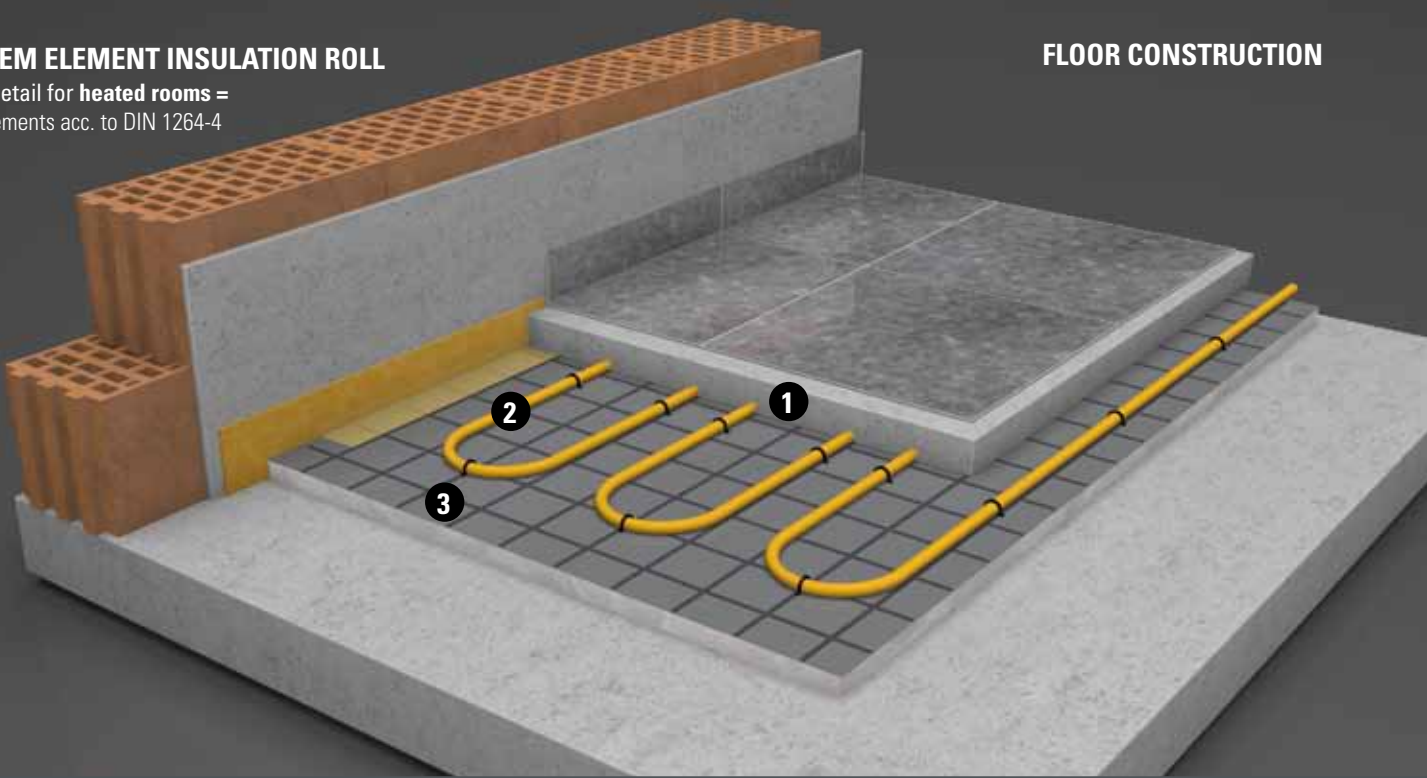

Example of structure	Type of screed					
	Cement screed CT-F4		Cement screed CT-F5*		Floating screed CAF-F4/F5	
1. Construction height of screed	65 mm		46 mm		51 mm	
2. Heating pipe	16 x 2 mm		16 x 2 mm		16 x 2 mm	
3. Insulation roll	Art No. 91035	Art.-No. 91033	Art No. 91035	Art.-No. 91033	Art No. 91035	Art.-No. 91033
Height	35 mm	30 mm	35 mm	30 mm	35 mm	30 mm
4. Insulation e.g. EPS DEO (WLG 040)	-	-	-	-	-	-
<b>= construction height without flooring</b>	<b>100 mm</b>	<b>95 mm</b>	<b>81 mm</b>	<b>76 mm</b>	<b>86 mm</b>	<b>81 mm</b>

## SYSTEM ELEMENT INSULATION ROLL

Floor detail for **unheated rooms** =  
Requirements acc. to EnEV  
(minimum requirements acc. to EN 1264-4)

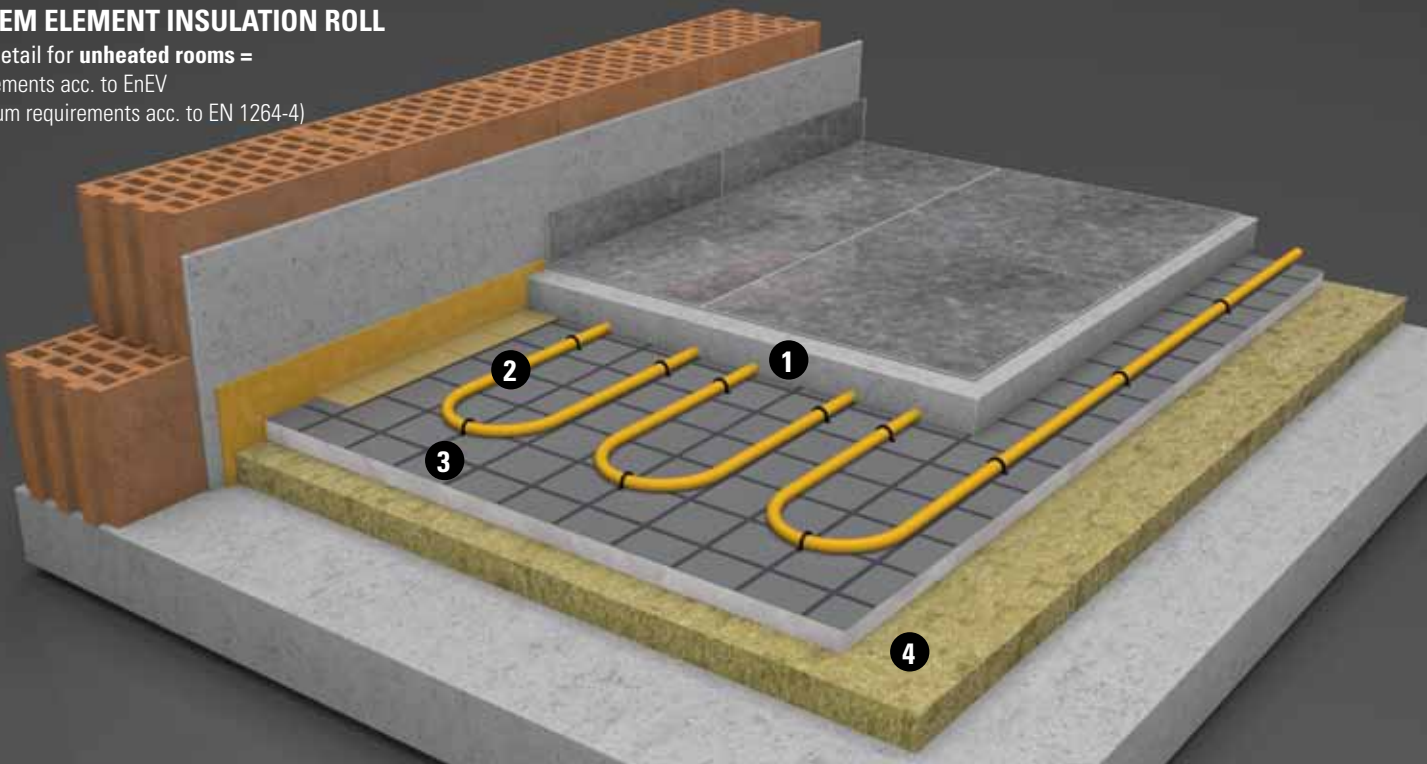

Example of structure	Type of screed					
	Cement screed CT-F4		Cement screed CT-F5*		Floating screed CAF-F4/F5	
1. Construction height of screed	65 mm		46 mm		51 mm	
2. Heating pipe	16 x 2 mm		16 x 2 mm		16 x 2 mm	
3. Insulation roll	Art No. 91035	Art.-No. 91033	Art No. 91035	Art.-No. 91033	Art No. 91035	Art.-No. 91033
Height	35 mm	30 mm	35 mm	30 mm	35 mm	30 mm
4. Insulation e.g. EPS DEO (WLG 040)	20 mm	20 mm	20 mm	20 mm	20 mm	20 mm
<b>= construction height without flooring</b>	<b>120 mm</b>	<b>115 mm</b>	<b>101 mm</b>	<b>96 mm</b>	<b>106 mm</b>	<b>101 mm</b>

## SYSTEM ELEMENT INSULATION ROLL

Floor detail for **ground** =  
Requirements acc. to EnEV  
(minimum requirements acc. to EN 1264-4)

## FLOOR CONSTRUCTION

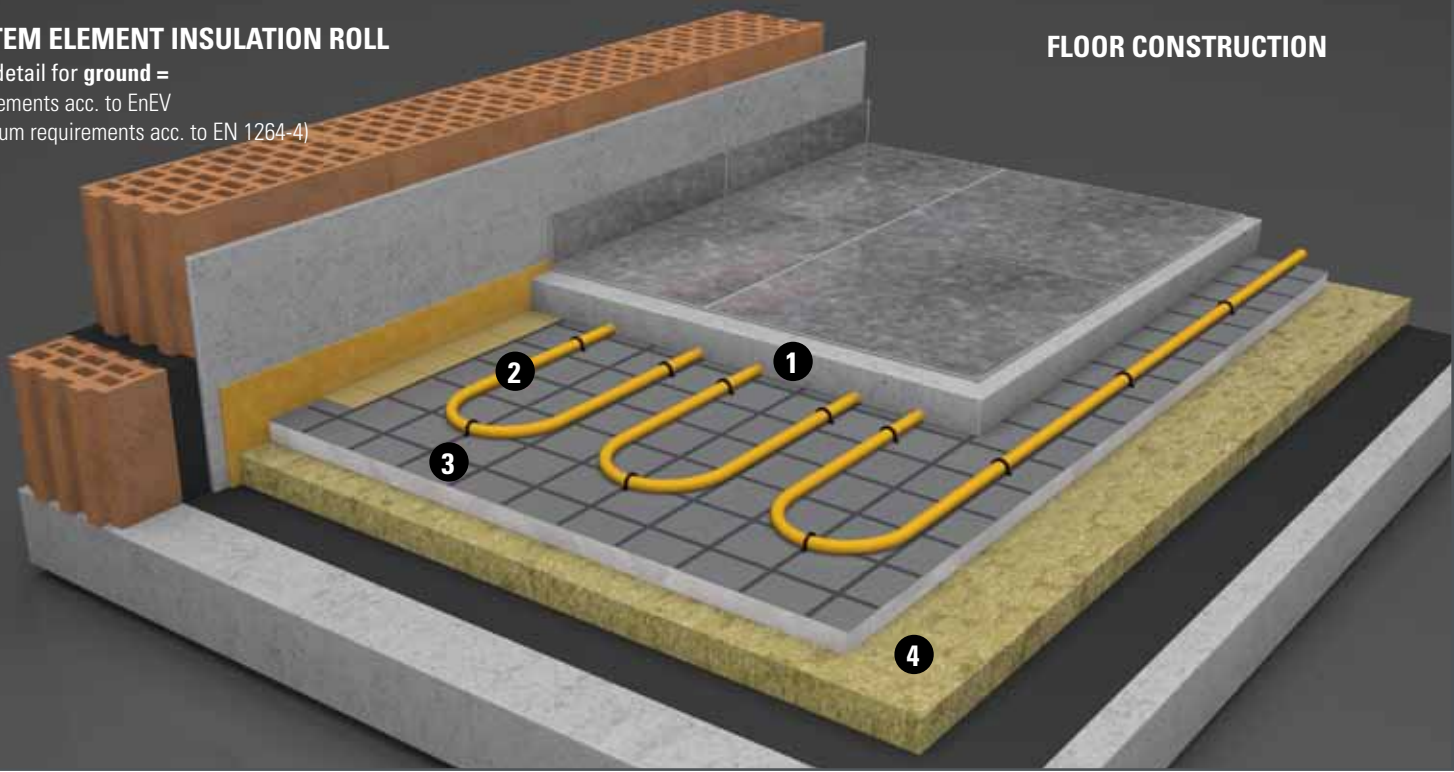

Example of structure	Type of screed					
	Cement screed CT-F4		Cement screed CT-F5*		Floating screed CAF-F4/F5	
1. Construction height of screed	65 mm		46 mm		51 mm	
2. Heating pipe	16 x 2 mm		16 x 2 mm		16 x 2 mm	
3. Insulation roll	Art No. 91035	Art.-No. 91033	Art No. 91035	Art.-No. 91033	Art No. 91035	Art.-No. 91033
Height	35 mm	30 mm	35 mm	30 mm	35 mm	30 mm
4. Insulation e.g. EPS DEO (WLG 040)	20 mm	20 mm	20 mm	20 mm	20 mm	20 mm
<b>= construction height without flooring</b>	<b>120 mm</b>	<b>115 mm</b>	<b>101 mm</b>	<b>96 mm</b>	<b>106 mm</b>	<b>101 mm</b>

## SYSTEM ELEMENT INSULATION ROLL

Floor detail for **outside air** =  
Requirements acc. to EnEV  
(minimum requirements acc. to EN 1264-4)

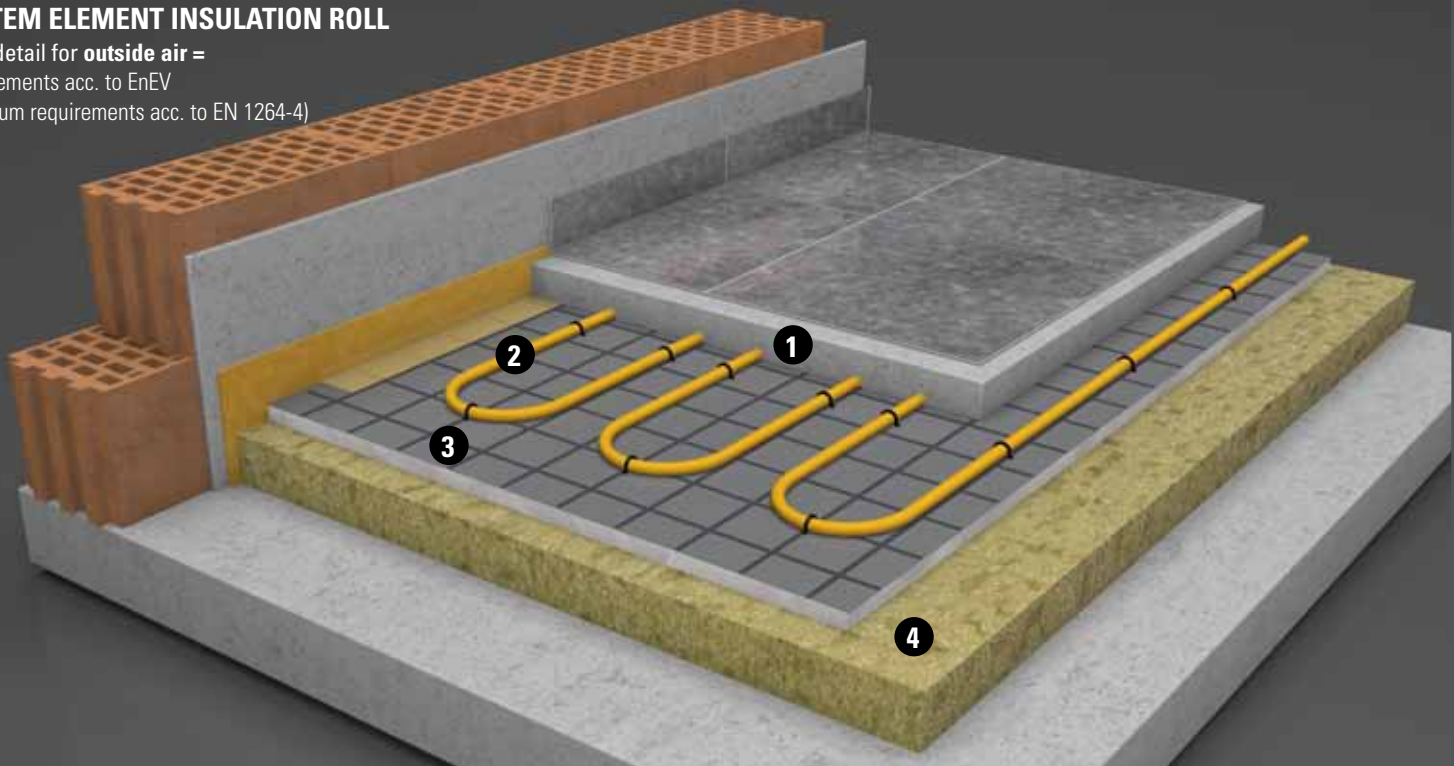

Example of structure	Type of screed					
	Cement screed CT-F4		Cement screed CT-F5*		Floating screed CAF-F4/F5	
1. Construction height of screed	65 mm		46 mm		51 mm	
2. Heating pipe	16 x 2 mm		16 x 2 mm		16 x 2 mm	
3. Insulation roll	Art No. 91035	Art.-No. 91033	Art No. 91035	Art.-No. 91033	Art No. 91035	Art.-No. 91033
Height	35 mm	30 mm	35 mm	30 mm	35 mm	30 mm
4. Insulation e.g. EPS DEO (WLG 040)	50 mm	50 mm	50 mm	50 mm	50 mm	50 mm
<b>= construction height without flooring</b>	<b>150 mm</b>	<b>145 mm</b>	<b>131 mm</b>	<b>126 mm</b>	<b>136 mm</b>	<b>131 mm</b>

## SYSTEM ELEMENT ALUMINIUM FOIL WITH IMPRINTED GRID

### System element aluminium foil

#### Characteristics

The aquatherm orange system-system element aluminium foil is an aluminium covered coating improving the heat distribution.

The grid coating is placed on commercial insulations. The fabrics at the upper surface effect a close fixing of the heating pipes by means of pipe clips.

The self-adhesive profile rails are also applicable.

The grid foil has to be laid with an overlapping of at least 80 mm and fixed with plastic nails or by pasting up the linings.

#### Special advantages

- › Variable laying distances
- › Exact placing of heating pipe - horizontal and vertical - acc. to DIN EN 1264
- › Applicable on all commercial high resistance foam insulations.
- › No cuttings.
- › Imprinted screen for placing (Division: 50 mm rising).
- › Well suitable for liquid screed.

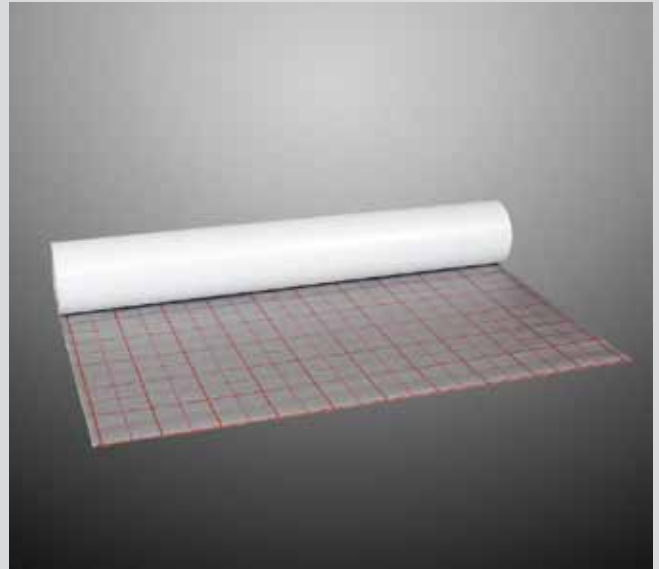

aluminium foil

Technical data aluminium foil
Length: 100.000 mm
Width: 1.030 mm
Overlapping: 30 mm
Packing unit: 50 m <sup>2</sup>
Screen-Printing: 50 / 100 mm
Art.-No. 91210

## SYSTEM ELEMENT ALUMINIUM FOIL

Floor detail for **heated rooms**=  
Requirements acc. to DIN 1264-4

## FLOOR CONSTRUCTION

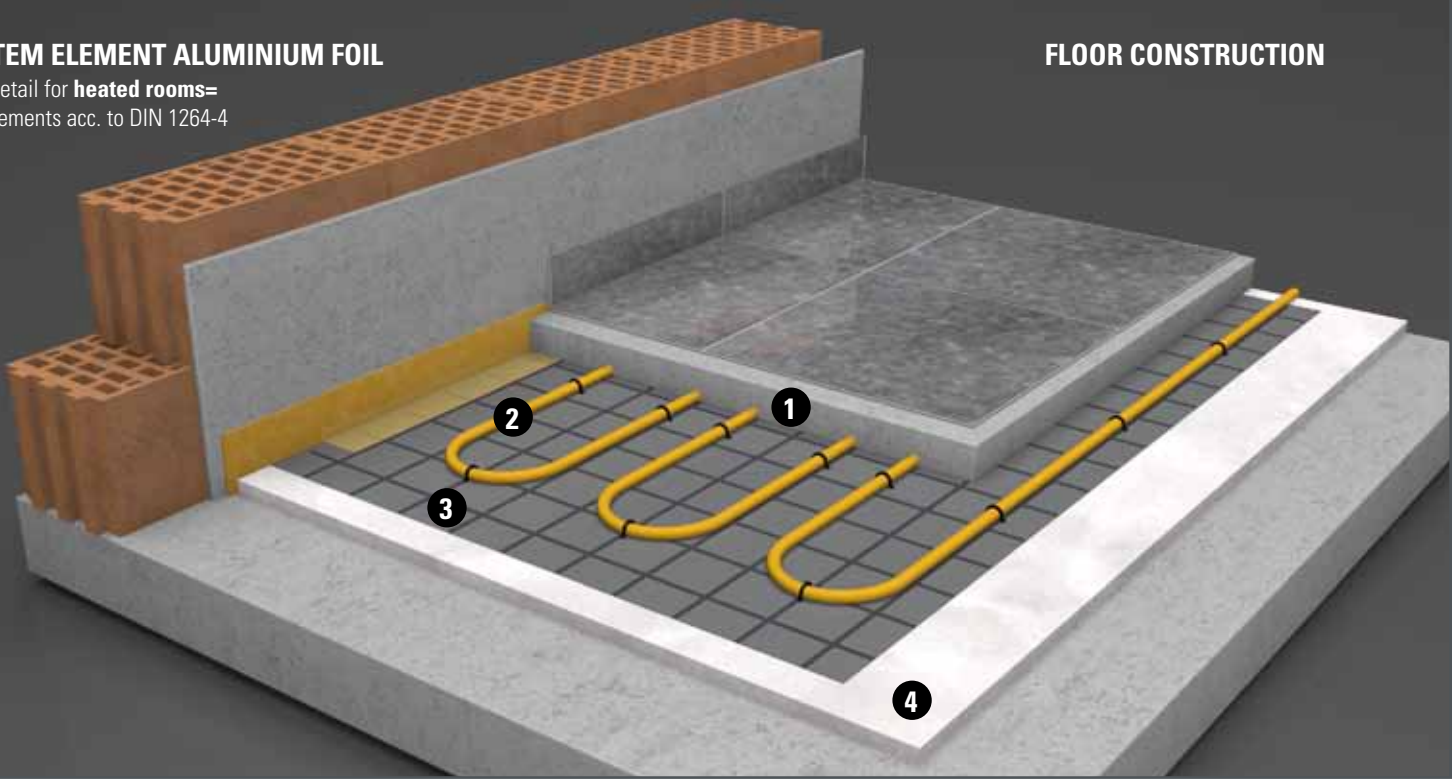

Example of structure	Type of screed		
	Cement screed CT-F4	Cement screed CT-F5*	Floating screed CAF-F4/F5
1. Construction height of screed	65 mm	46 mm	51 mm
2. Heating pipe	16 x 2 mm	16 x 2 mm	16 x 2 mm
3. Aluminium foil	Art No. 91210	Art No. 91210	Art No. 91210
4. Insulation e.g. EPS DEO (WLG 040)	30 mm	30 mm	30 mm
<b>= construction height without flooring</b>	<b>95 mm</b>	<b>76 mm</b>	<b>81 mm</b>

## SYSTEM ELEMENT ALUMINIUM FOIL

Floor detail for **unheated rooms**=  
Requirements acc. to EnEV  
(minimum requirements acc. to EN 1264-4)

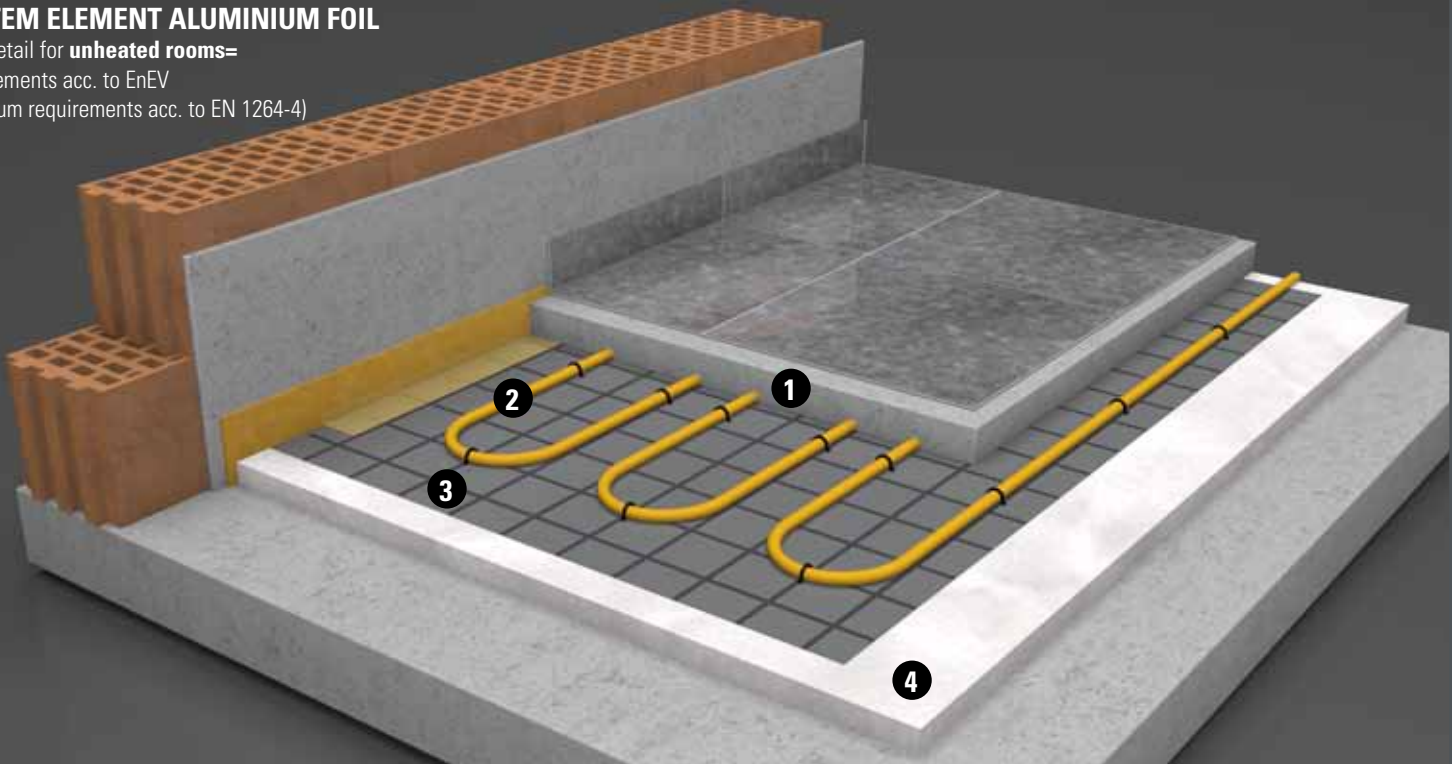

Example of structure	Type of screed		
	Cement screed CT-F4	Cement screed CT-F5*	Floating screed CAF-F4/F5
1. Construction height of screed	65 mm	46 mm	51 mm
2. Heating pipe	16 x 2 mm	16 x 2 mm	16 x 2 mm
3. Aluminium foil	Art No. 91210	Art No. 91210	Art No. 91210
4. Insulation e.g. EPS DEO (WLG 040)	50 mm	50 mm	50 mm
<b>= construction height without flooring</b>	<b>115 mm</b>	<b>96 mm</b>	<b>101 mm</b>

## SYSTEM ELEMENT ALUMINIUM FOIL

Floor detail for **ground** =

Requirements acc. to EnEV  
(minimum requirements acc. to EN 1264-4)

## FLOOR CONSTRUCTION

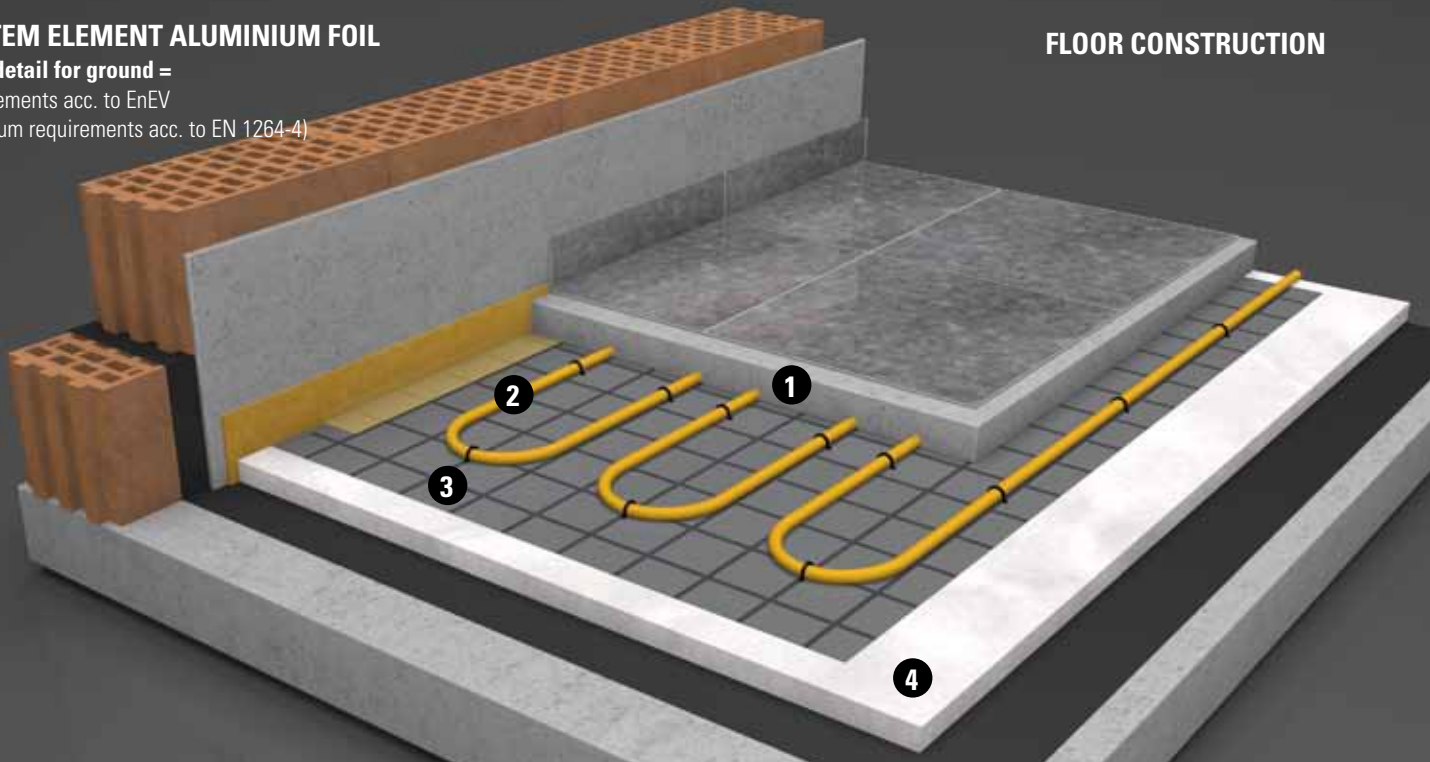

Example of structure	Type of screed		
	Cement screed CT-F4	Cement screed CT-F5*	Floating screed CAF-F4/F5
1. Construction height of screed	65 mm	46 mm	51 mm
2. Heating pipe	16 x 2 mm	16 x 2 mm	16 x 2 mm
3. Aluminium foil	Art No. 91210	Art No. 91210	Art No. 91210
4. Insulation e.g. EPS DEO (WLG 040)	50 mm	50 mm	50 mm
<b>= construction height without flooring</b>	<b>115 mm</b>	<b>96 mm</b>	<b>105 mm</b>

## SYSTEM ELEMENT ALUMINIUM FOIL

Floor detail for **outside air** =

Requirements acc. to EnEV  
(minimum requirements acc. to EN 1264-4)

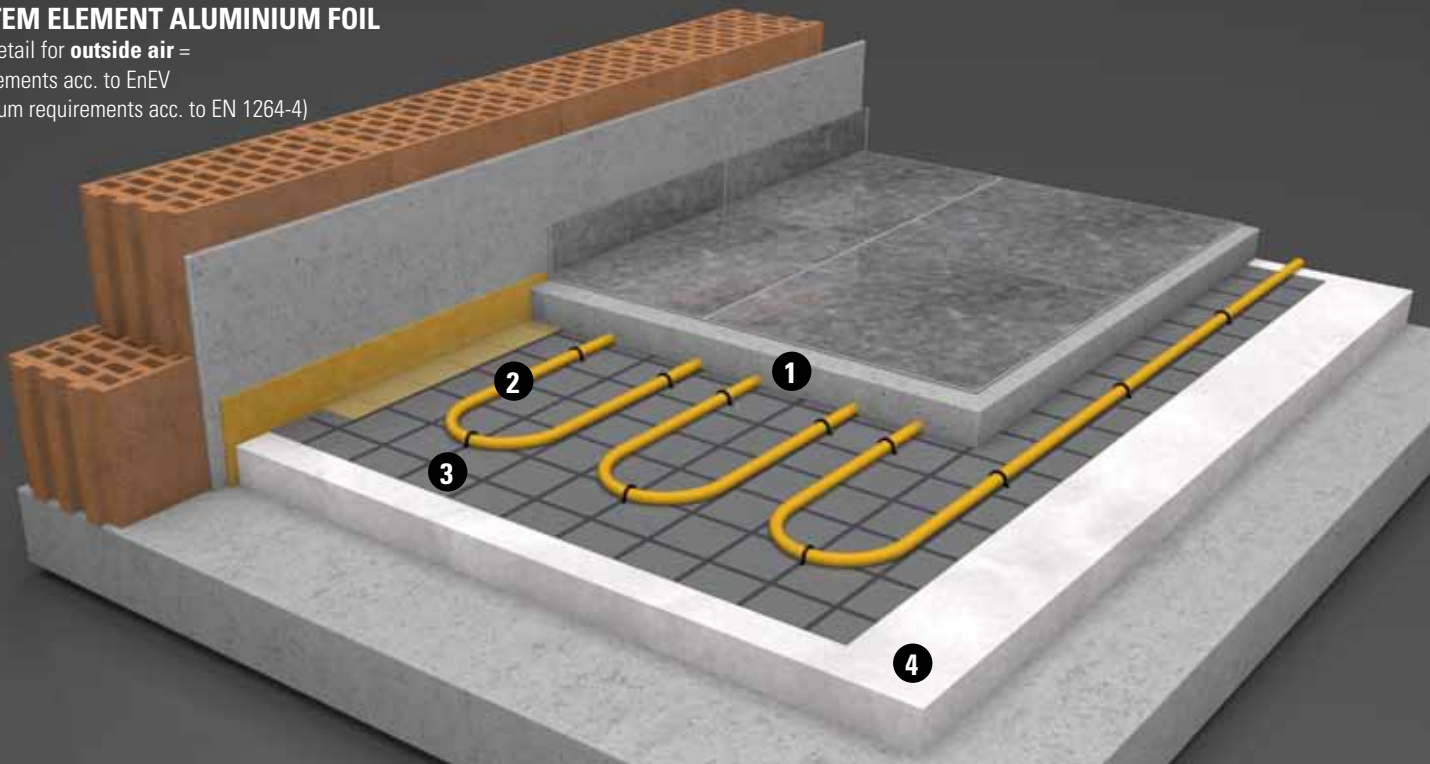

Example of structure	Type of screed		
	Cement screed CT-F4	Cement screed CT-F5*	Floating screed CAF-F4/F5
1. Construction height of screed	65 mm	46 mm	51 mm
2. Heating pipe	16 x 2 mm	16 x 2 mm	16 x 2 mm
3. Aluminium foil	Art No. 91210	Art No. 91210	Art No. 91210
4. Insulation e.g. EPS DEO (WLG 040)	80 mm	80 mm	80 mm
<b>= construction height without flooring</b>	<b>145 mm</b>	<b>126 mm</b>	<b>131 mm</b>

## ACCESSORIES FOR SYSTEM ELEMENTS

### aquatherm orange system -Pipe clip

#### Characteristics

aquatherm orange system elements are equipped with a proven woven cloth. The pipe clip is pressed over the heating pipes, through the body ply into the insulation.

The barbs of the pipe clip brace in the cloth and keep the aquatherm orange system-floor heating pipes.



Pipe clip

Technical data pipe clip
Material: Polyamide
Dimension: 14-17 mm
Art.-No. 90504
Material: Polyamide
Dimension: 20 mm
Art.-No. 90504

### aquatherm orange system - tacker

#### Characteristics

aquatherm orange system-pipe clips for the tacker are supplied in 25 piece magazines with self adhesive tape.

After filling the tacker with pipe clips, the placing is preferably made by 2 installers to reach shortest placing times.



Tackfix-tacker

## ACCESSORIES FOR SYSTEM ELEMENTS

### aquatherm orange system -Profile rail

#### Characteristics

With the aquatherm orange system -profile rail (alternative to tacker-technique) the floor heating pipes can be fixed on the insulation.

The profile rail is provided with a self-adhesive tape at the bottom side effecting its safe fixing.

Quick assembly-times are guaranteed due to rated break points, at which the rail can be cut without additional tools. Pipes can be divided into 50 mm distances.

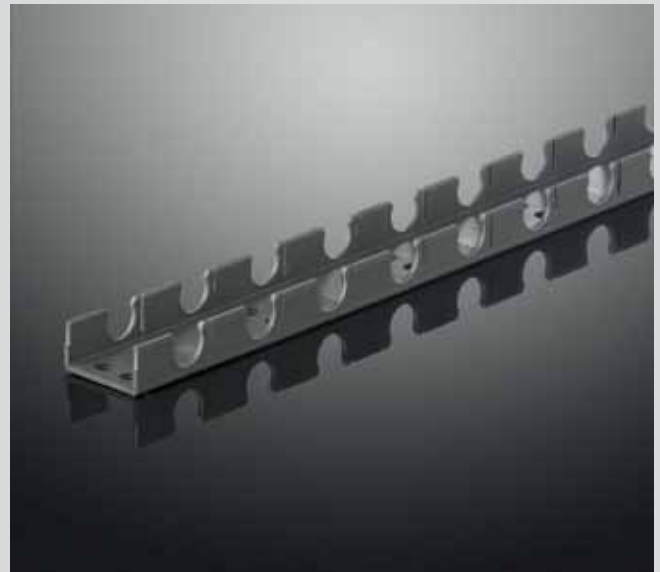

Profile rail

Technical data profile rail	
Length: 2000 mm	
Material: Polyamide	
Pipe distance: 50 mm	
Dimension 14 mm	Art-No. 90515
Dimension 16 mm	Art-No. 90517
Dimension 20 mm	Art-No. 90518

### aquatherm orange system -Self adhesive tape

#### Characteristics

The aquatherm orange system-self adhesive tape closes the gaps at the joints of the system elements.

The gluing is made by means of a commercial manual dispenser and should be made directly after placing of the insulation elements.



Self adhesive tape

Technical data self adhesive tape	
Length: 66 m	
Width: 50 mm	
Art.-No. 91104	

**aquatherm orange system**

**SYSTEM ELEMENT KNOB PLATE F ND 30-2**

**Characteristics**

The aquatherm orange system-system element knob plate F ND 30-2 is made of polystyrene high resistance foam with integrated pipe keeping knobs.

The surface is refined with PS-foil and has overlays.

The knobs are safe and keep the heating pipes perfectly.

The element has a sound insulation at its under side.

The element is suitable for heating pipes of dimension 14 x 2.0 mm, 16 x 2.0 mm. or 17x2,0mm.

**Special advantages**

- Variable pipe spacings in 50 mm grid.
- Ideal for liquid screed due to special overlapping.
- Good heat efficiency due to complete pipe integration.
- One-man-placing without problems.
- Easy assembly without special tools.
- Exact placing of heating pipe - horizontal and vertical - conform to DIN EN 1264.
- Diagonal laying also possible.



System element knob plate F ND 30-2

Technical Data knob plate F ND 30-2
Thermal resistance: 0.75 m <sup>2</sup> K / W
Insulation size: 30 mm
Total size inclusive pipe holding knobs: 49 mm
Max. working load: 5.0 kN / m <sup>2</sup>
Dynamic rigidity: 20 MN/m <sup>3</sup>
Impact sound improvement size: 28 dB
Artikel-Nr. 91115

In combination with additional insulation material the requirements of EnEV can be met.

## SYSTEM ELEMENT KNOB PLATE F ND 30-2

Intermediate floor with **heated lower rooms** =  
Requirements acc. DIN 1264-4

## FLOOR CONSTRUCTION

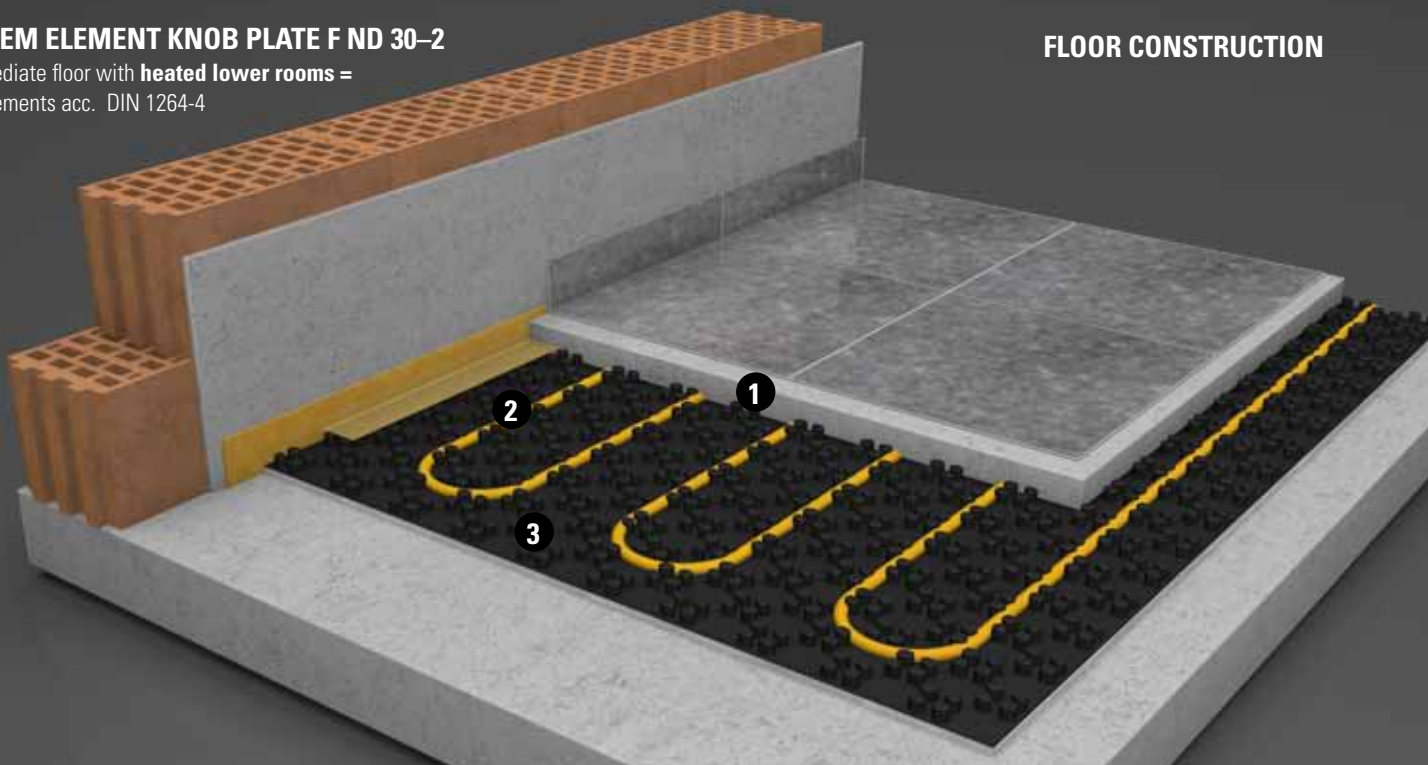

Example of structure	Type of screed		
	Cement screed CT-F4	Cement screed CT-F5*	Floating screed CAF-F4/F5
1. Construction height of screed	65 mm	46 mm	51 mm
2. Heating pipe	16 x 2 mm	16 x 2 mm	16 x 2 mm
3. Knob plate F ND 30-2	Art No. 91115	Art No. 91115	Art No. 91115
Height	30 mm	30 mm	30 mm
4. Insulation e.g. EPS DEO (WLG 040)	-	-	-
<b>= construction height without flooring</b>	<b>95 mm</b>	<b>76 mm</b>	<b>81 mm</b>

## SYSTEM ELEMENT KNOB PLATE F ND 30-2

Floor detail for **unheated rooms** =  
Requirements acc. to EnEV  
(minimum requirements acc. to EN 1264-4)

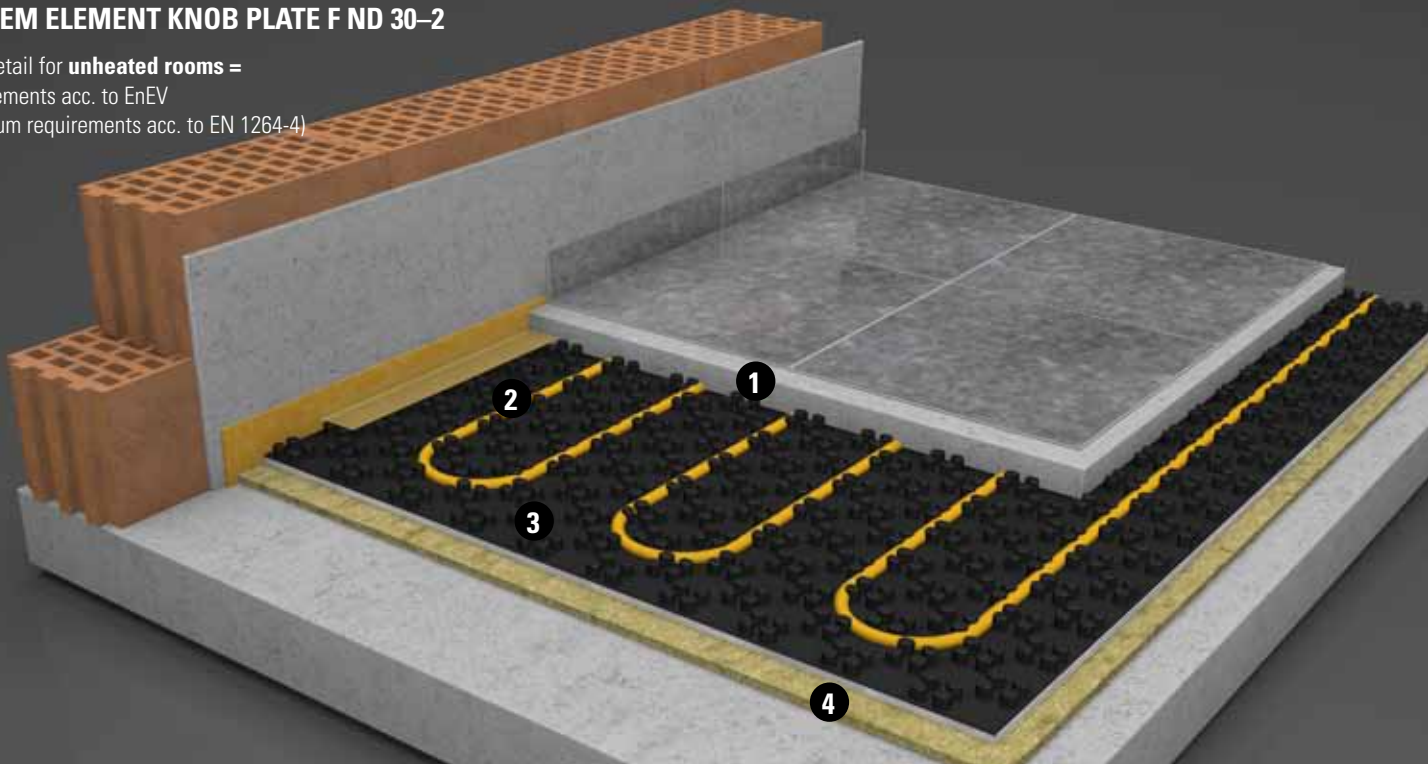

Example of structure	Type of screed		
	Cement screed CT-F4	Cement screed CT-F5*	Floating screed CAF-F4/F5
1. Construction height of screed	65 mm	46 mm	51 mm
2. Heating pipe	16 x 2 mm	16 x 2 mm	16 x 2 mm
3. Knob plate F ND 30-2	Art No. 91115	Art No. 91115	Art No. 91115
Height	30 mm	30 mm	30 mm
4. Insulation e.g. EPS DEO (WLG 040)	20 mm	20 mm	20 mm
<b>= construction height without flooring</b>	<b>115 mm</b>	<b>96 mm</b>	<b>101 mm</b>

## SYSTEM ELEMENT KNOB PLATE F ND 30-2

Floor detail for **ground =**  
Requirements acc. to EnEV  
(minimum requirements acc. to EN 1264-4)

## FLOOR CONSTRUCTION

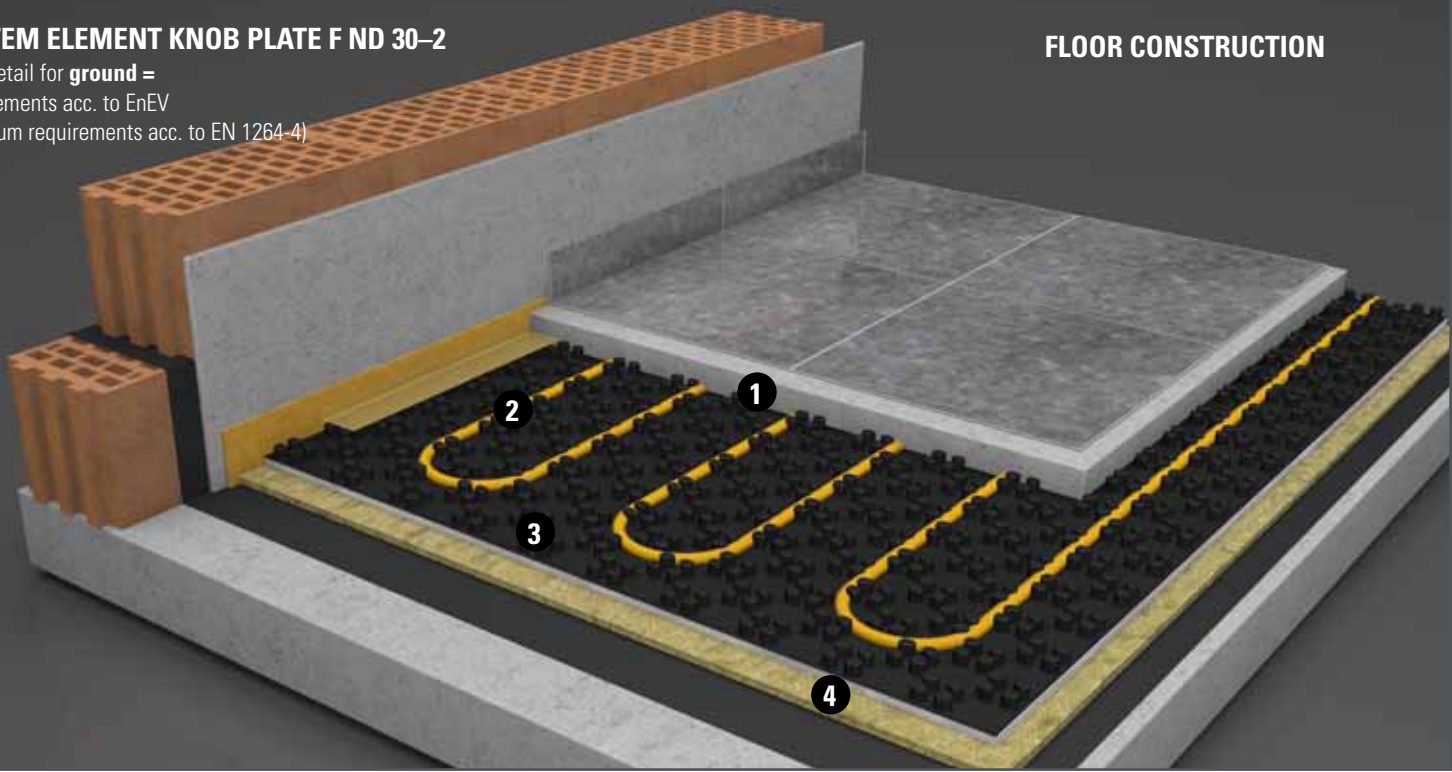

Example of structure	Type of screed		
	Cement screed CT-F4	Cement screed CT-F5*	Floating screed CAF-F4/F5
1. Construction height of screed	65 mm	46 mm	51 mm
2. Heating pipe	16 x 2 mm	16 x 2 mm	16 x 2 mm
3. Knob plate F ND 30-2	Art No. 91115	Art No. 91115	Art No. 91115
Height	30 mm	30 mm	30 mm
4. Insulation e.g. EPS DEO (WLG 040)	20 mm	20 mm	20 mm
<b>= construction height without flooring</b>	<b>115 mm</b>	<b>96 mm</b>	<b>101 mm</b>

## SYSTEM ELEMENT KNOB PLATE F ND 30-2

Floor detail for **outside air =**  
Requirements acc. to EnEV  
(minimum requirement acc. to EN 1264-4)

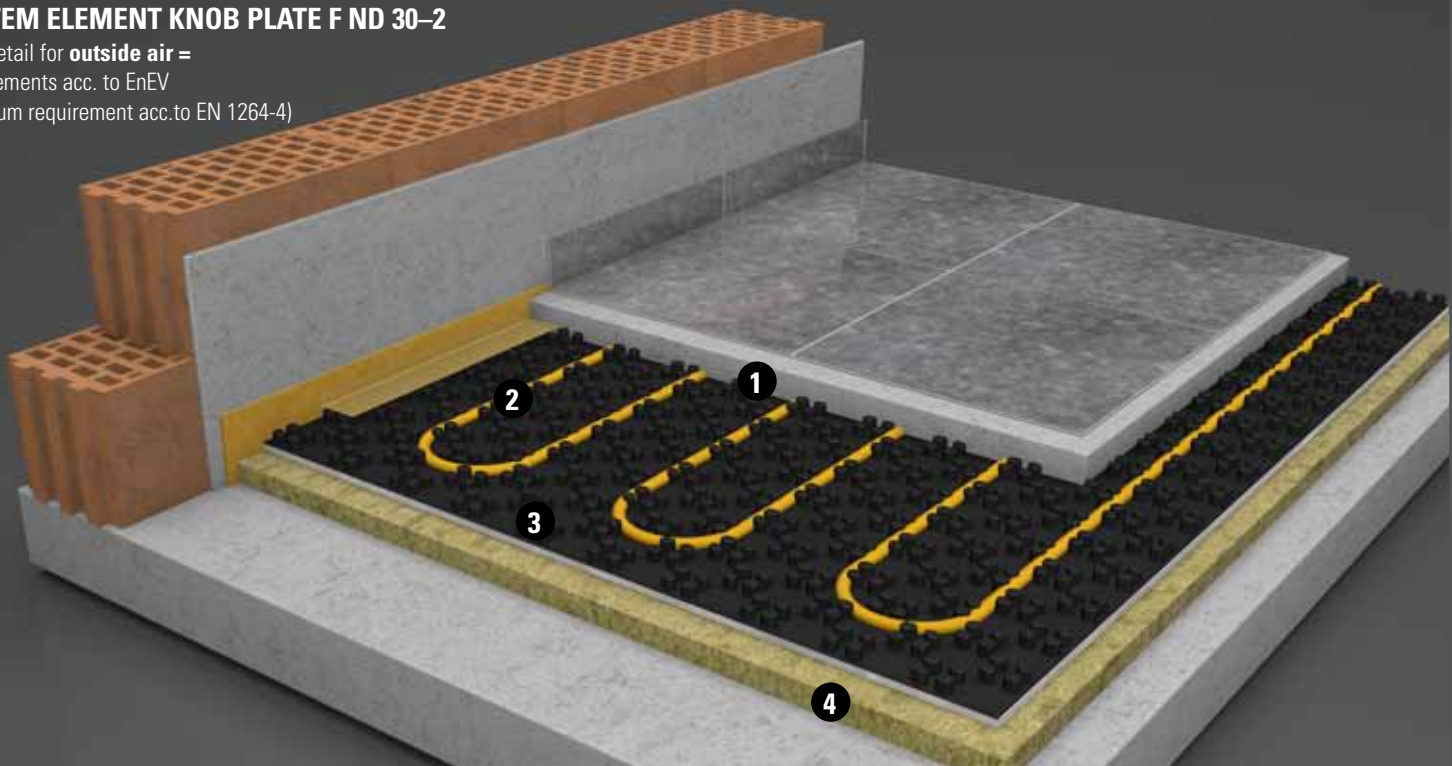

Example of structure	Type of screed		
	Cement screed CT-F4	Cement screed CT-F5*	Floating screed CAF-F4/F5
1. Construction height of screed	65 mm	46 mm	51 mm
2. Heating pipe	16 x 2 mm	16 x 2 mm	16 x 2 mm
3. Knob plate F ND 30-2	Art No. 91115	Art No. 91115	Art No. 91115
Height	30 mm	30 mm	30 mm
4. Insulation e.g. EPS DEO (WLG 040)	50 mm	50 mm	50 mm
<b>= construction height without flooring</b>	<b>145 mm</b>	<b>126 mm</b>	<b>131 mm</b>

## aquatherm orange system

### SYSTEM ELEMENT KNOB PLATE F ND 11

#### Characteristics

The aquatherm orange system-system element knob plate F ND 11 is made of polystyrene high resistance foam with integrated pipe keeping knobs.

The surface is refined with PS-foil and has overlays. The knobs are safe and keep the heating pipes in place. The element is equipped with 11 mm polystyrene high resistance foam EPS 200 at its underside.

There is a choice of 14 x 2.0 mm, 16 x 2.0 mm or 17 x 2.0 mm for the heating pipes which can be placed.

#### Special advantages

- variable pipe distances in 50 mm grid.
- Ideal for liquid screed due to folded joints on all sides and accessories.
- Good heat efficiency due to complete pipe integration.
- One-man-installation without problems.
- Easy assembly without special tools.
- Exact placing of heating pipe - horizontal and vertical - conform to DIN EN 1264.
- Applicable for all commercial high resistance foam insulations .
- Diagonal laying is also possible.
- On using "Lazenoflex-floor system" it is possible to achieve in smallest layer size a heated floor construction with pipes on the insulation (building type A1) in the field of reconstruction and renovation.
- The construction height above the heating pipes is only about 10 mm (without covering)
- Total construction height about 45 mm
- Covering materials like tiles, bricks, terracotta, clinker pavement are suitable

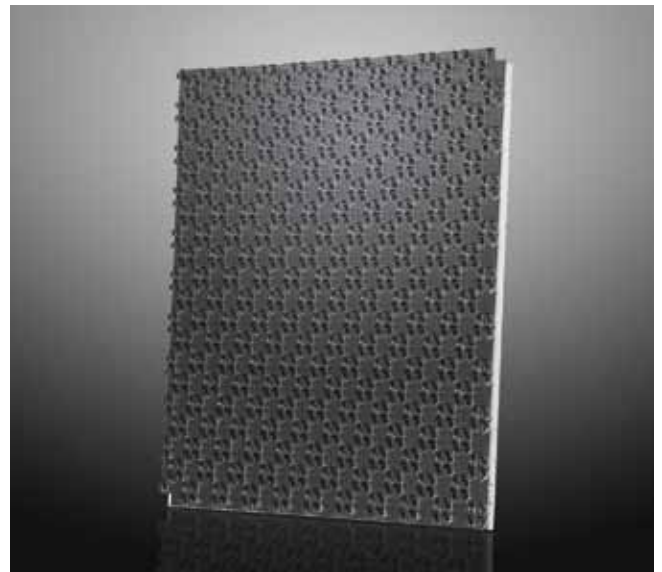

System element knob plate F ND 11

Technical Data knob plate F ND 11
Thermal resistance: 0.314 m <sup>2</sup> K/W
Insulation size: 11 mm
Total size inclusive pipe holding knobs: 30 mm
Max. working load: 60.0 kN / m <sup>2</sup>
Impact sound improvement size: without
Art.-No. 91112

In combination with additional insulation material the requirements of EnEV can be met.

## SYSTEM ELEMENT KNOB PLATE F ND 11

Intermediate floor with **heated lower rooms** =  
Requirements acc. to DIN 1264-4

## FLOOR CONSTRUCTION

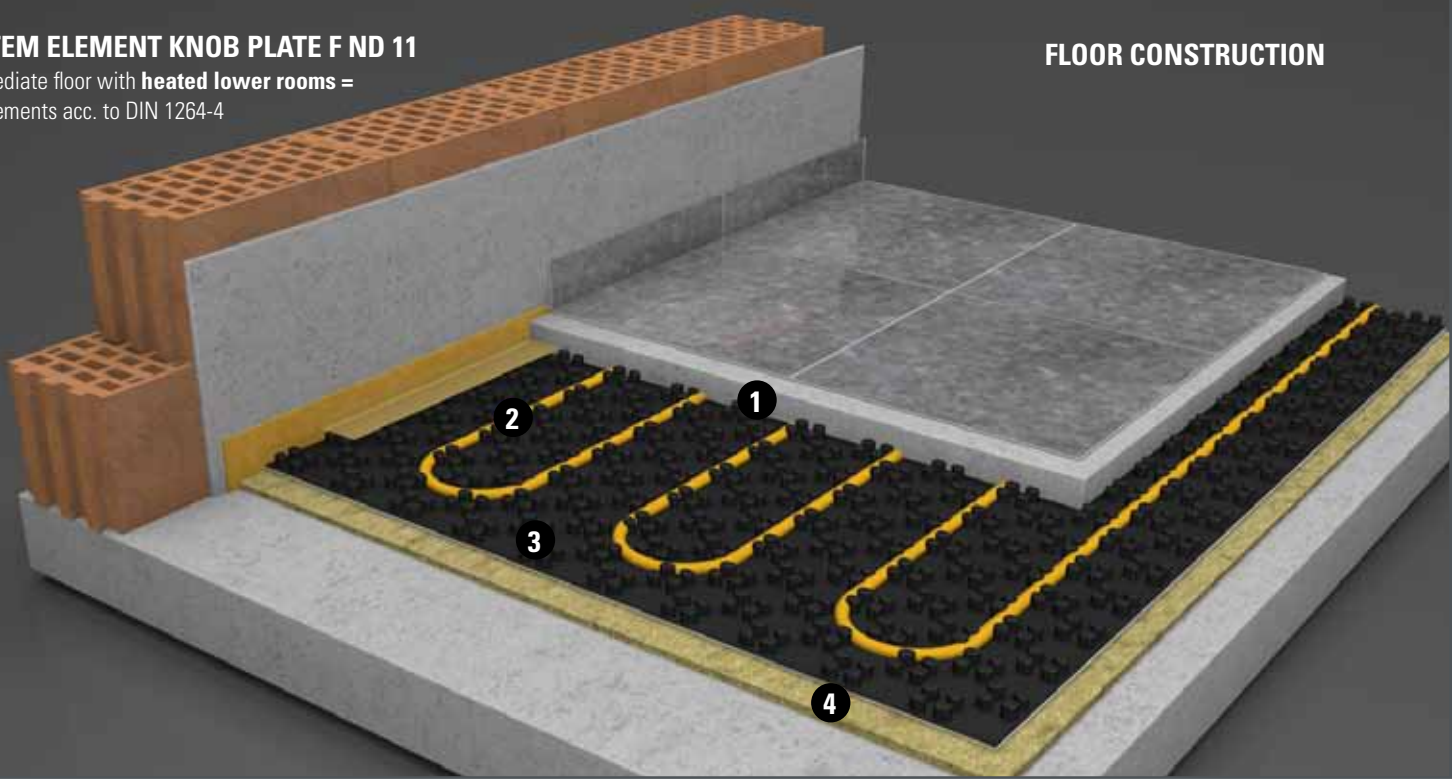

Example of structure	Type of screed		
	Cement screed CT-F4	Cement screed CT-F5*	Floating screed CAF-F4/F5
1. Construction height of screed	65 mm	46 mm	51 mm
2. Heating pipe	16 x 2 mm	16 x 2 mm	16 x 2 mm
3. Knob plate F ND 11	Art No. 91112	Art No. 91112	Art No. 91112
Height	11 mm	11 mm	11 mm
4. Insulation e.g. EPS DEO (WLG 040)	20 mm	20 mm	20 mm
<b>= construction height without flooring</b>	<b>96 mm</b>	<b>77 mm</b>	<b>82 mm</b>

## SYSTEM ELEMENT KNOB PLATE F ND 11

Floor detail for **unheated rooms** =  
Requirements acc. to EnEV  
(minimum requirement acc. to EN 1264-4)

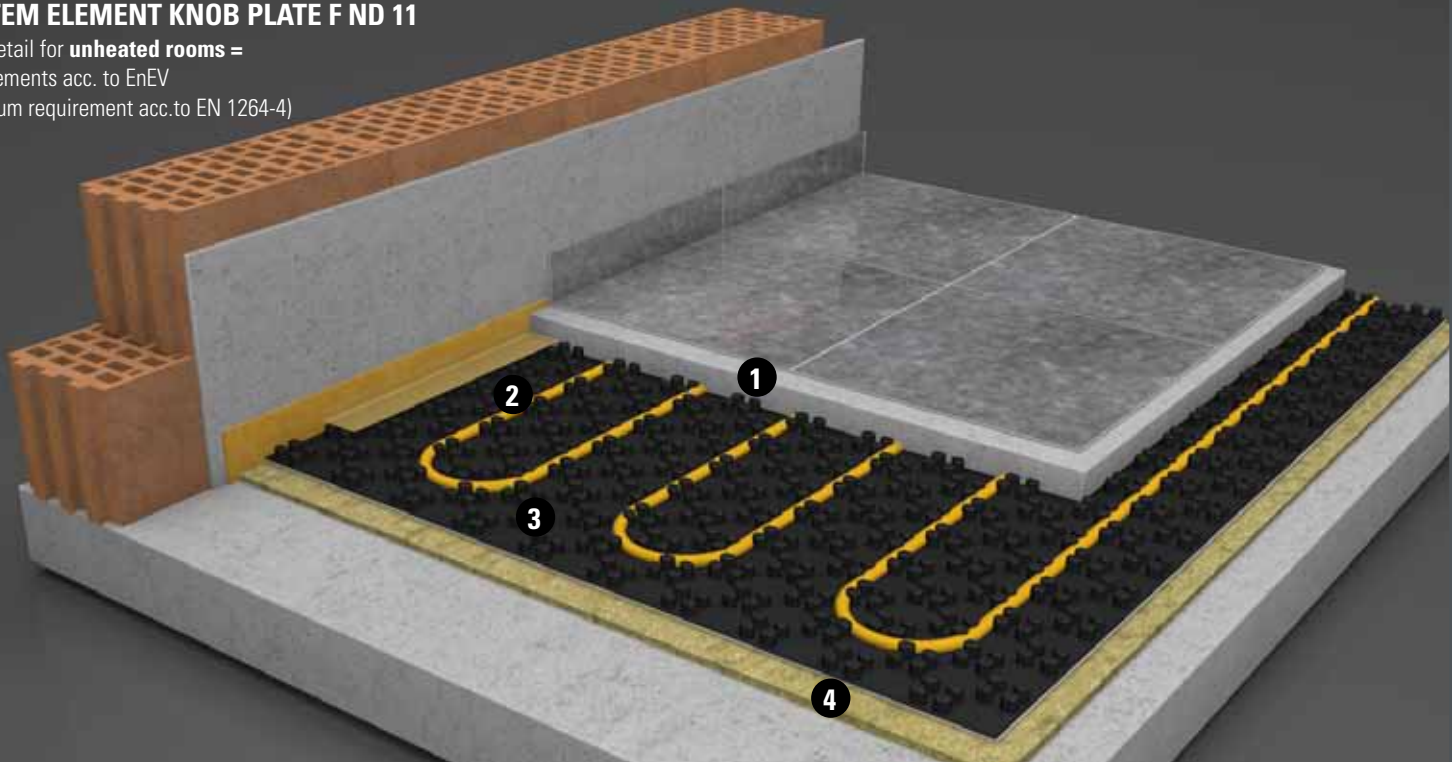

Example of structure	Type of screed		
	Cement screed CT-F4	Cement screed CT-F5*	Floating screed CAF-F4/F5
1. Construction height of screed	65 mm	46 mm	51 mm
2. Heating pipe	16 x 2 mm	16 x 2 mm	16 x 2 mm
3. Knob plate F ND 11	Art No. 91112	Art No. 91112	Art No. 91112
Height	11 mm	11 mm	11 mm
4. Insulation e.g. EPS DEO (WLG 040)	40 mm	40 mm	40 mm
<b>= construction height without flooring</b>	<b>116 mm</b>	<b>97 mm</b>	<b>101 mm</b>

## SYSTEM ELEMENT KNOB PLATE F ND 11

Floor detail for **ground=**  
Requirements acc. to EnEV  
(minimum requirement acc. to EN 1264-4)

## FLOOR CONSTRUCTION

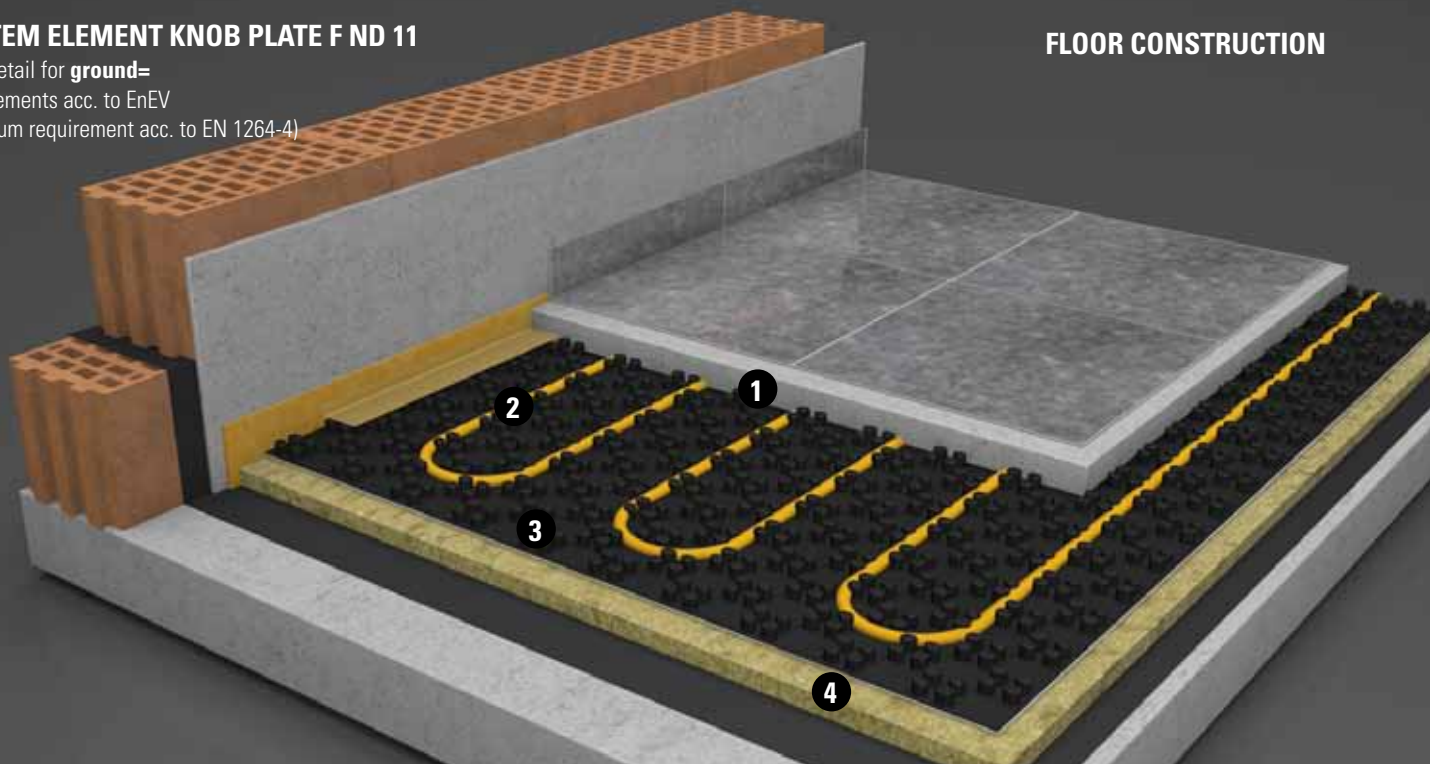

Example of structure	Type of screed		
	Cement screed CT-F4	Cement screed CT-F5*	Floating screed CAF-F4/F5
1. Construction height of screed	65 mm	46 mm	51 mm
2. Heating pipe	16 x 2 mm	16 x 2 mm	16 x 2 mm
3. Knob plate F ND 11	Art No. 91112	Art No. 91112	Art No. 91112
Height	11 mm	11 mm	11 mm
4. Insulation e.g. EPS DEO (WLG 040)	40 mm	40 mm	40 mm
<b>= construction height without flooring</b>	<b>116 mm</b>	<b>97 mm</b>	<b>101 mm</b>

## SYSTEM ELEMENT KNOB PLATE F ND 11

Floor detail for **outside air =**  
Requirements acc. to EnEV  
(minimum requirements acc. to EN 1264-4)

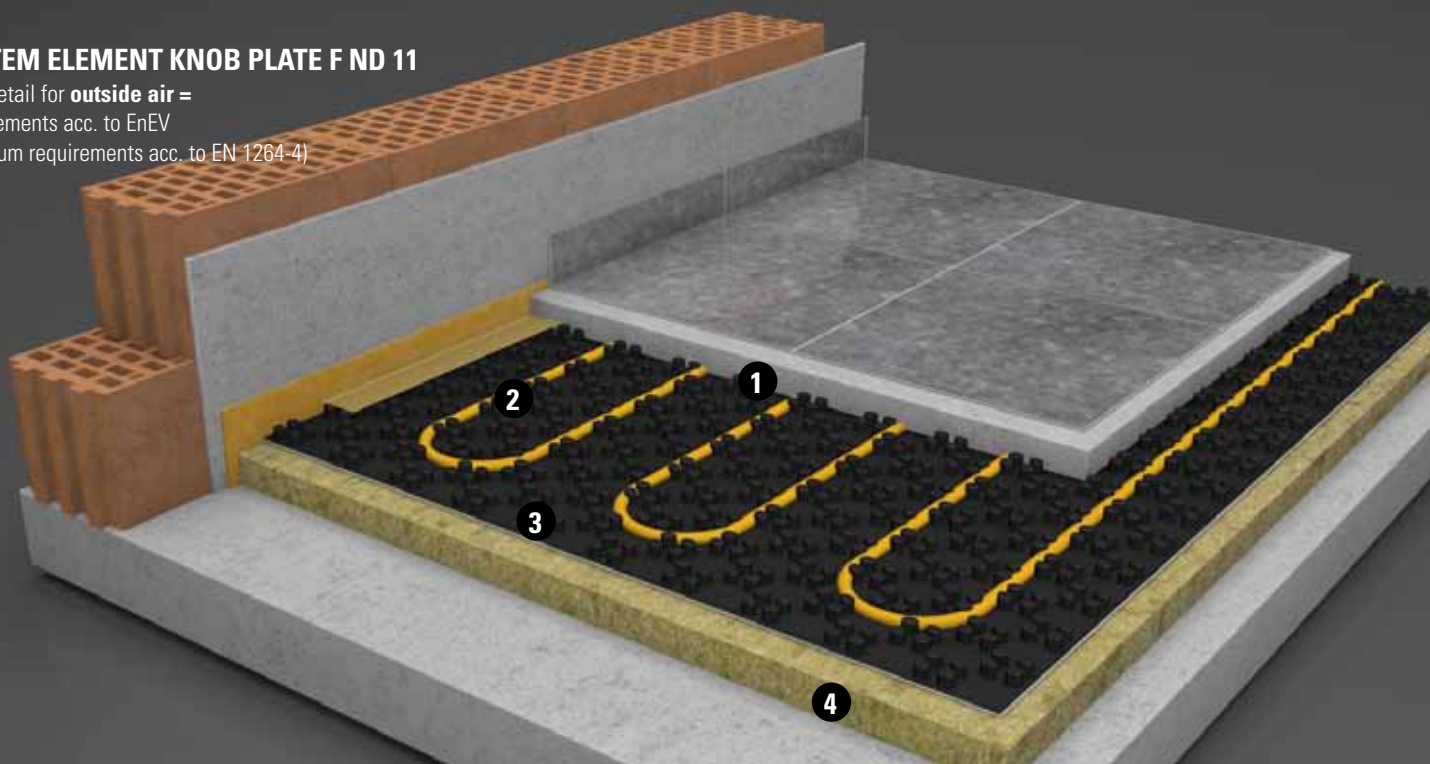

Example of structure	Type of screed		
	Cement screed CT-F4	Cement screed CT-F5*	Floating screed CAF-F4/F5
1. Construction height of screed	65 mm	46 mm	51 mm
2. Heating pipe	16 x 2 mm	16 x 2 mm	16 x 2 mm
3. Knob plate F ND 11	Art No. 91112	Art No. 91112	Art No. 91112
Height	11 mm	11 mm	11 mm
4. Insulation e.g. EPS DEO (WLG 040)	70 mm	70 mm	70 mm
<b>= construction height without flooring</b>	<b>146 mm</b>	<b>127 mm</b>	<b>132 mm</b>

**aquatherm orange system**

**SYSTEM ELEMENT TS 25**

**Characteristics**

The aquatherm orange system -system element TS 25 is made of polystyrene high resistance foam EPS 035 DEO (PS 30 SE) with integrated pipe channels.

These pipe channels are equipped with heat conducting steel sheet to improve the heat distribution and to fix the elements. The still integrated pipe channel in the bottom area can be used for passing connection supplies.

The system element is applied e.g. in areas where customary wet construction systems are not applicable.

Therefore it is the ideal alternative for refurbishment of old buildings which cannot take the normal admissible weight of approx. 130-150 kg /m<sup>2</sup>.

The usual floor drying time can be renounced on using dry floors also in the field of prefabricated houses.

The system element is designed for heating pipe 14 x 2,0 mm.

The system element TS 25 has no impact sound insulation improvement.

If an impact sound insulation is required this could be met by the application of specially designed practices.

On using dry screed the application of e.g. Fermacell-screed comb 30 mm is recommended. Manufacturer would provide the values of impact sound insulation improvement.

For wet screed e.g. extruded polyethylene foam 5 mm can be applied. These products are available at the building material trade.

Generally a calculation of heating load acc. to DIN EN 12831 must be provided before laying the underfloor heating with the system elements. The type of screed and surface covering should be known.

Allowance should be made for the most extreme case where floor covering is to be specified later. Similarly where the floor covering is expected to be changed later.

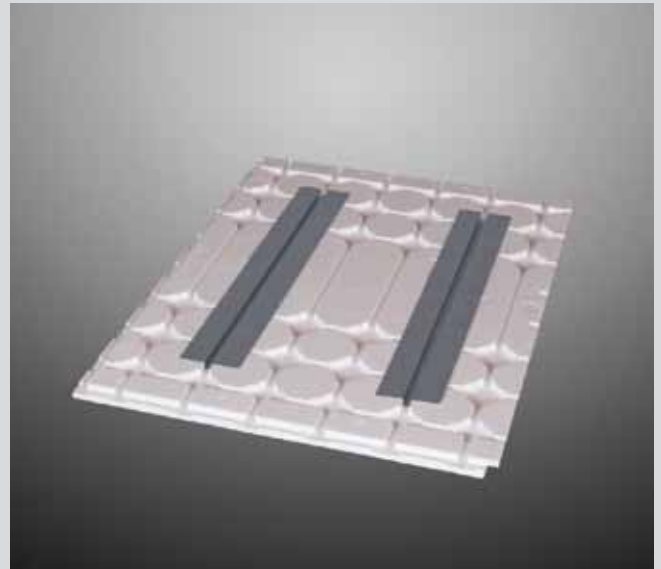

System element TS 25

Technical Data System element TS 25
Thermal resistance: 0.714 m <sup>2</sup> K / W
Insulation size: 25 mm
Max. working load: 60 kN / m <sup>2</sup>
Impact sound improvement size: without
Size of elements: 1025 x 770 x 25 mm
Floorspace: 1005 x 750 x 0,754 m <sup>2</sup>
Insulation plate Art.-Nr. 91039

Technical data of heat conduction module
Dimension : 750 x 118 mm with rated brake point 20/75 mm
Material requirements for spacing: PS 125 mm = 7.5m/m <sup>2</sup> = 10 pcs./m <sup>2</sup> PS 250 mm = 3,75 m/m <sup>2</sup> = 5 pcs./m <sup>2</sup>
Heat conduction module (Art.-No. 91041)

In combination with additional insulation material the requirements of the EnEV are met.

## SYSTEMELEMENT TS 25

Intermediate floor with **heated lower rooms** =  
Requirements acc. to DIN 1264-4

## FLOOR CONSTRUCTION

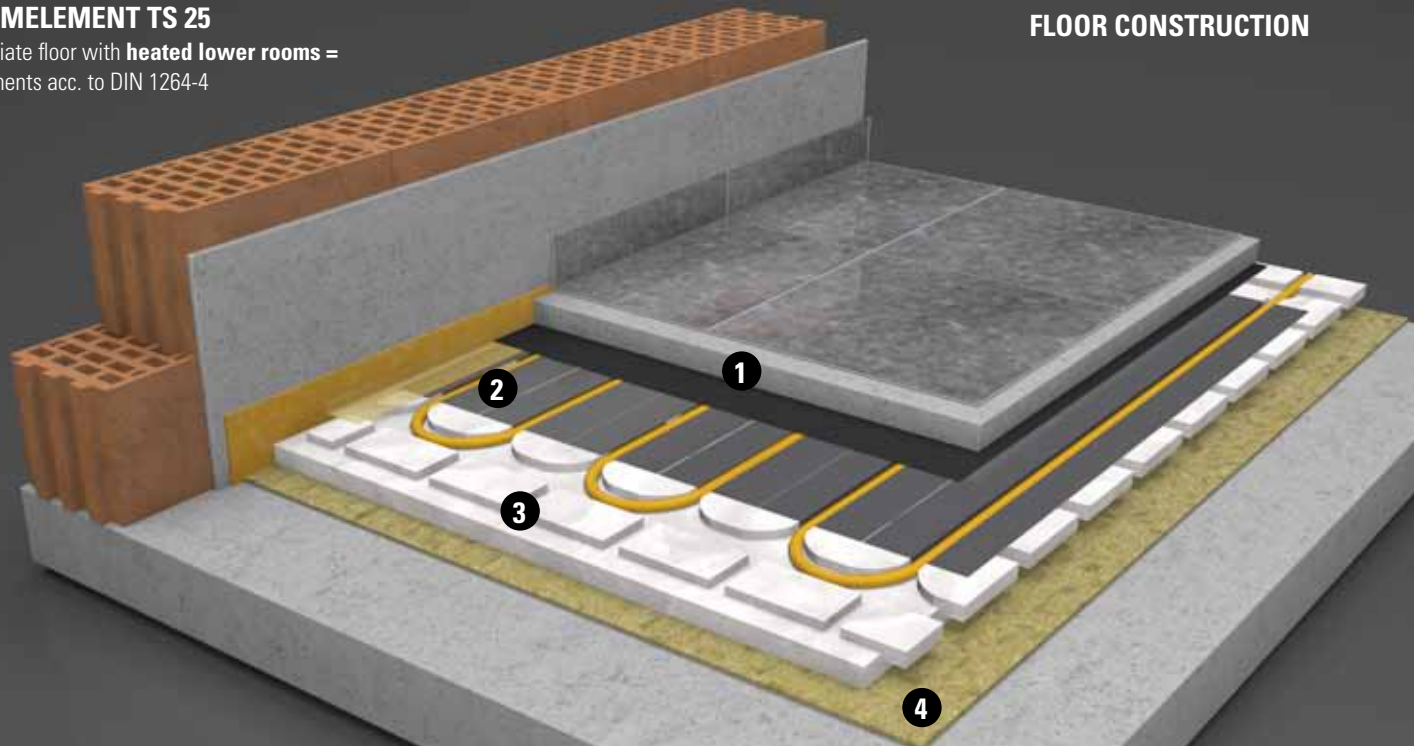

Example of structure	Type of screed		
	Cement screed CT-F4	Cement screed CT-F5*	Floating screed CAF-F4/F5
1. Construction height of screed	45 mm	30 mm	35 mm
2. Heating pipe	14 x 2 mm	14 x 2 mm	14 x 2 mm
3. System element TS 25	Art No. 91039	Art No. 91039	Art No. 91039
Height	25 mm	25 mm	25 mm
4. Insulation e.g. EPS DEO (WLG 040)	10 mm	10 mm	10 mm
<b>= construction height without flooring</b>	<b>80 mm</b>	<b>65 mm</b>	<b>70 mm</b>

## SYSTEMELEMENT TS 25

Floor detail for **unheated rooms** =  
Requirements acc. to EnEV  
(minimum requirements acc. to EN 1264-4)

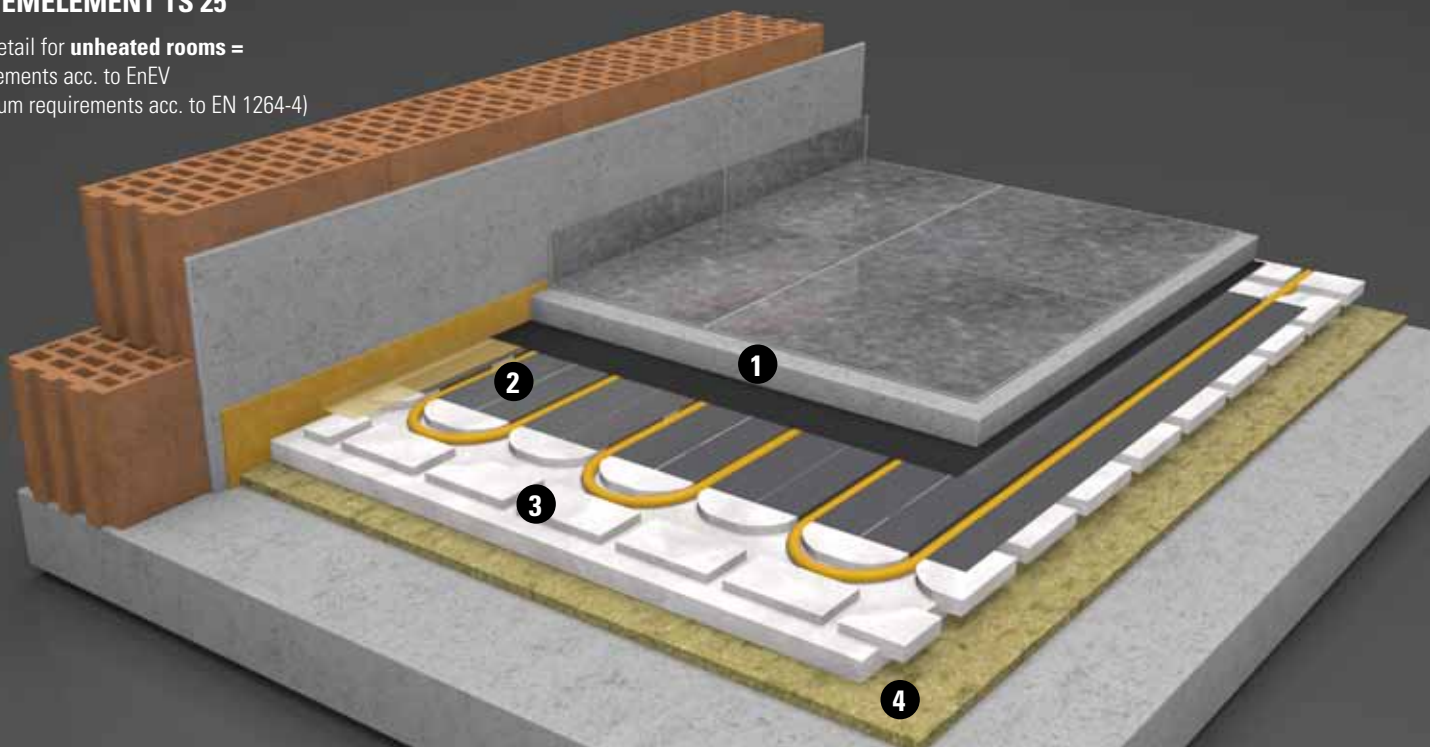

Example of structure	Type of screed		
	Cement screed CT-F4	Cement screed CT-F5*	Floating screed CAF-F4/F5
1. Construction height of screed	45 mm	30 mm	35 mm
2. Heating pipe	14 x 2 mm	14 x 2 mm	14 x 2 mm
3. System element TS 25	Art Nr. 91039	Art Nr. 91039	Art Nr. 91039
Height	25 mm	25 mm	25 mm
4. Insulation e.g. EPS DEO (WLG 040)	25 mm	25 mm	25 mm
<b>= construction height without flooring</b>	<b>95 mm</b>	<b>80 mm</b>	<b>85 mm</b>

## SYSTEMELEMENT TS 25

Intermediate floor with **heated lower rooms** =  
Requirements acc. to DIN 1264-4

## FLOOR CONSTRUCTION

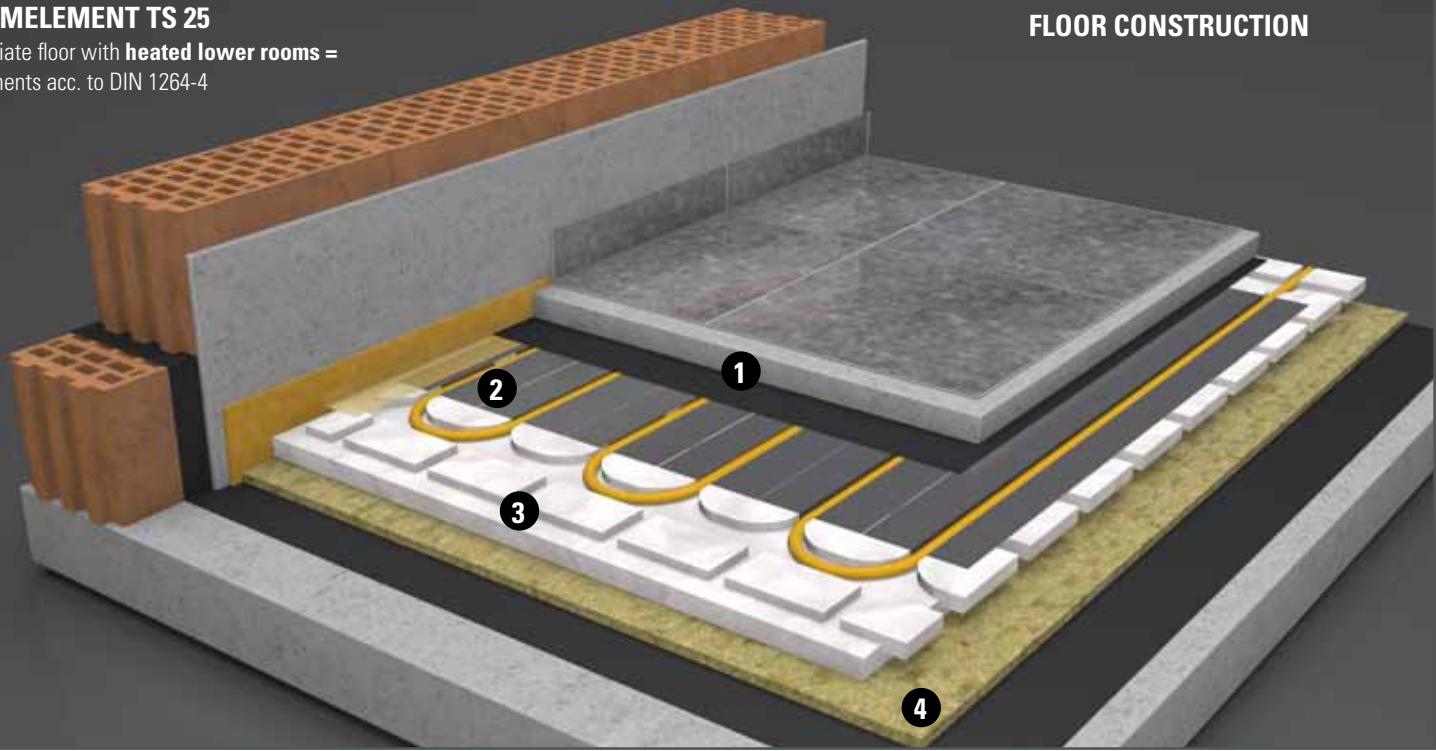

Example of structure	Type of screed		
	Cement screed CT-F4	Cement screed CT-F5*	Floating screed CAF-F4/F5
1. Construction height of screed	45 mm	30 mm	35 mm
2. Heating pipe	14 x 2 mm	14 x 2 mm	14 x 2 mm
3. System element TS 25	Art No. 91039	Art No. 91039	Art No. 91039
Height	25 mm	25 mm	25 mm
4. Insulation e.g. EPS DEO (WLG 040)	25 mm	25 mm	25 mm
<b>= construction height without flooring</b>	<b>90 mm</b>	<b>75 mm</b>	<b>80 mm</b>

## SYSTEMELEMENT TS 25

Floor detail for **outside air** =  
Requirements acc. to EnEV  
(minimum requirements acc. to EN 1264-4)

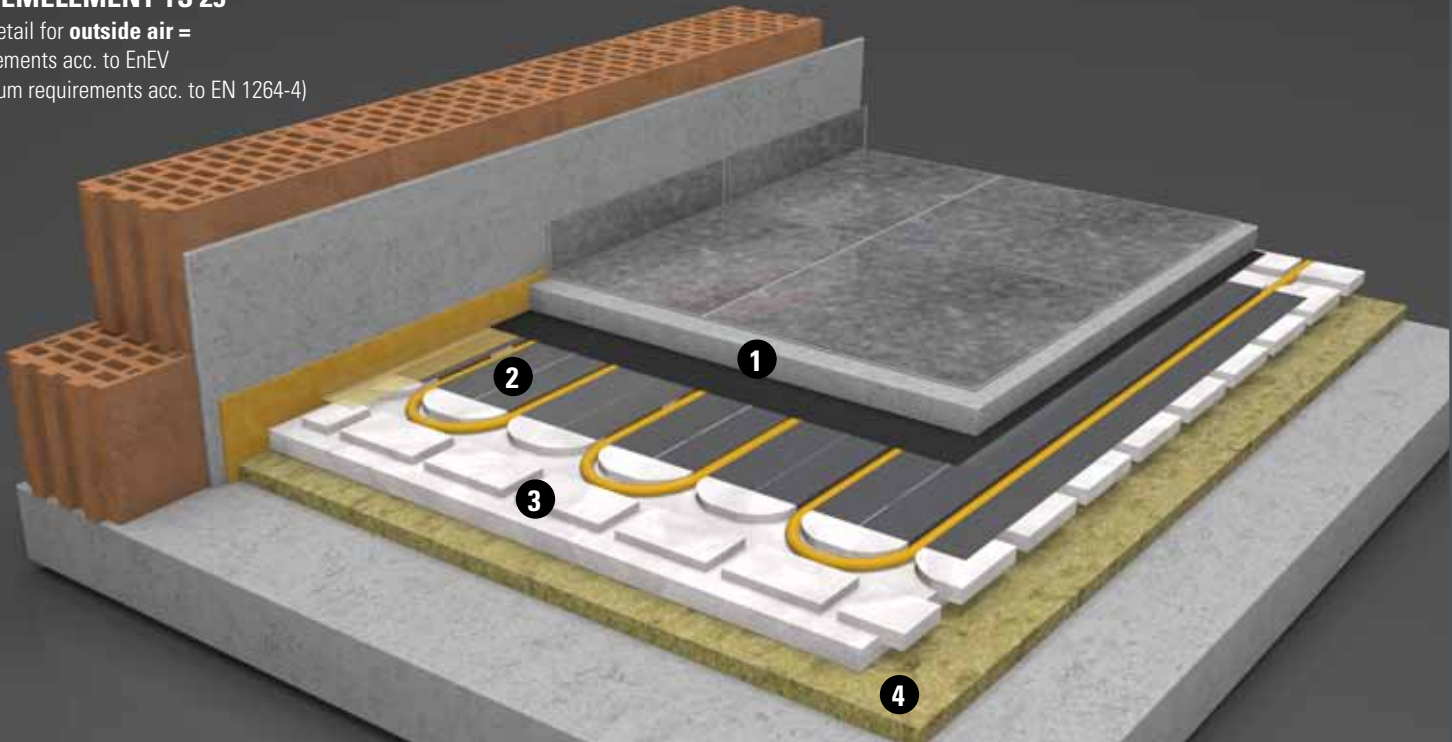

Example of structure	Type of screed		
	Cement screed CT-F4	Cement screed CT-F5*	Floating screed CAF-F4/F5
1. Construction height of screed	45 mm	30 mm	35 mm
2. Heating pipe	14 x 2 mm	14 x 2 mm	14 x 2 mm
3. System element TS 25	Art Nr. 91039	Art Nr. 91039	Art Nr. 91039
Height	25 mm	25 mm	25 mm
4. Insulation e.g. EPS DEO (WLG 040)	55 mm	55 mm	55 mm
<b>= construction height without flooring</b>	<b>95 mm</b>	<b>80 mm</b>	<b>85 mm</b>

## SYSTEM ELEMENT TS 25 WITH DRY FLOOR ELEMENTS

for the refurbishment of old buildings

## FLOOR CONSTRUCTION

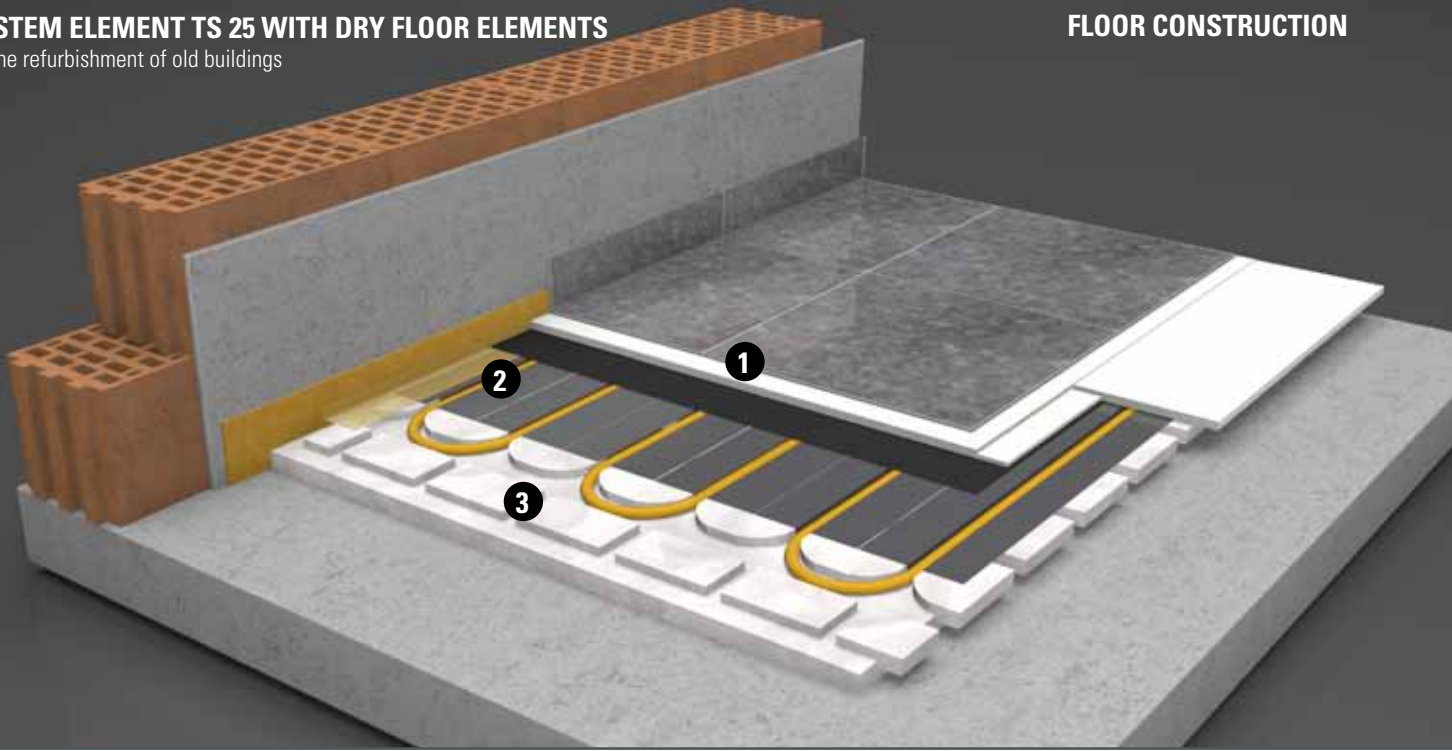

Example of structure	Dry floor element / Prefab screed		
	Prefab screed Knauf BRIO 18	Fermacell screed element 2 E 22	
1. Thickness of dry floor element	18 mm	25 mm	
2. Heating pipe	14 x 2 mm	14 x 2 mm	
3. System element TS 25	Art No. 91039	Art No. 91039	
Height	25 mm	25 mm	
4. Additional insulation	-	-	
<b>= construction height without flooring</b>	<b>43 mm</b>	<b>50 mm</b>	

## SYSTEM ELEMENT TS 25 WITH DRY FLOOR ELEMENTS

for the refurbishment of old buildings (wooden beam ceilings)

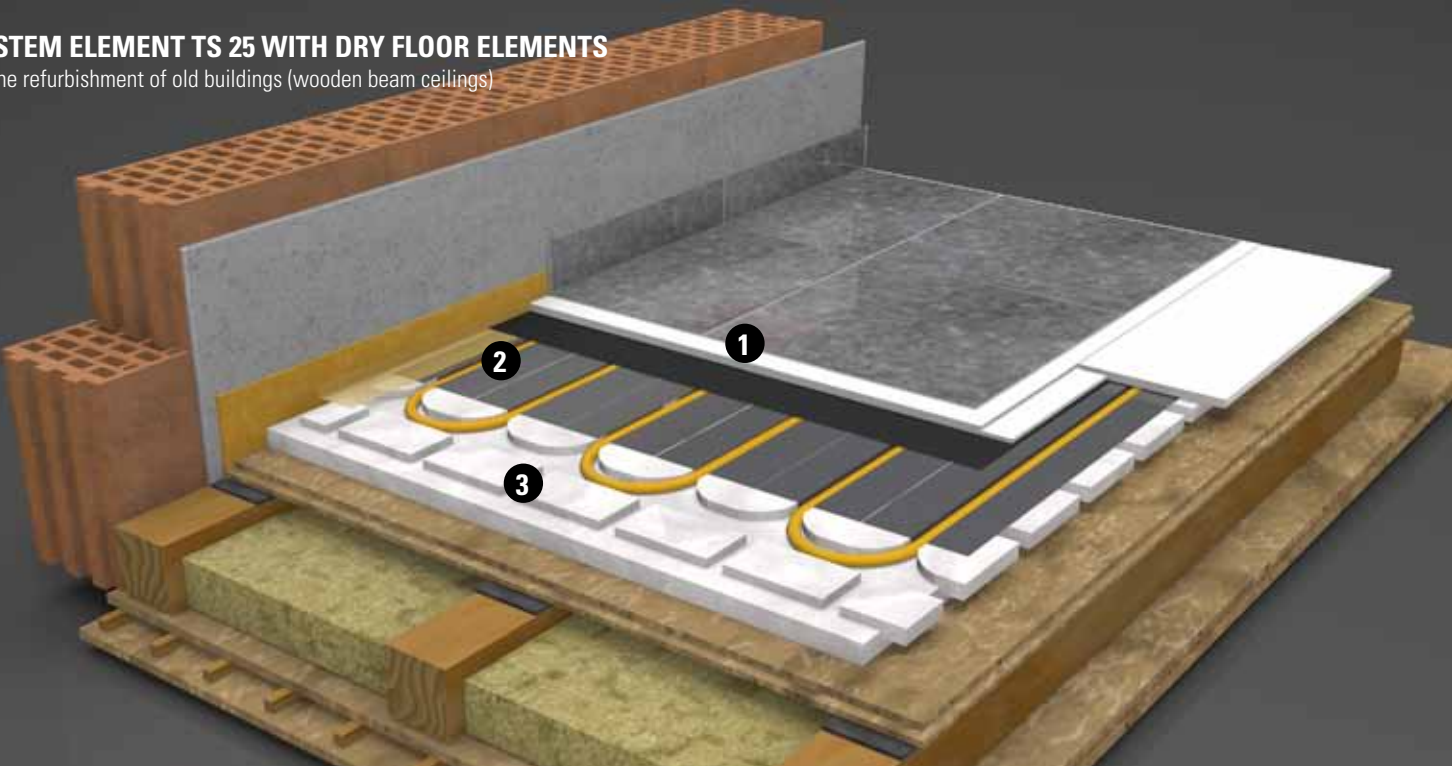

Example of structure	Dry floor element / Prefab screed		
	Prefab screed Knauf BRIO 18	Fermacell screed element 2 E 22	
1. Construction height of screed	18 mm	25 mm	
2. Heating pipe	14 x 2 mm	14 x 2 mm	
3. System element TS 25	Art Nr. 91039	Art Nr. 91039	
Height	25 mm	25 mm	
4. Insulation e.g. EPS DEO (WLG 040)	-	-	
<b>= construction height without flooring</b>	<b>43 mm</b>	<b>50 mm</b>	

**aquatherm orange system**

**EDGE INSULATION**

**Characteristics**

The aquatherm orange system -edge insulation is placed at all embracing areas.

There is an absorption layer for the heat expansion of the heated floor and a separation layer between flooring and mounting components, as well as impact sound insulation and heat insulation layer between the components.

Edge insulation must allow an expansion of cement floor up to 5 mm.

According to the requirements of the DIN 18560 excess edge insulation can only be removed after installation of the floor coverings.

**Special advantages**

- Material:  
Polyethylene foam 8 mm thick, 160 mm height.
- Perforated tear-off strip for different heights of cement floor.
- Welded PE-foil with adhesive strip.
- Very low flammability.



Edge insulation

Technical data edge insulation	
	Length: 25 mm
	Height: 160 mm
	Width: 8 mm
	Art.-No. 91106

## aquatherm orange system

### EXPANSION JOINT SECTION

#### Characteristics

The formation of expansion joints e.g. in door areas causes considerable problems to the flooring paver as the connection supplies to the heating circuits cross the joint.

The perfect execution of an expansion joint can easily be done with the aquatherm orange system-expansion joint section.

In accordance with DIN 18560 a cement floor expansion of 5 mm to all directions is required.

Thus it is important to install expansion joint sections in door passages and between large areas of cement floor. These joints have to separate the cement floor in its total thickness up to the insulation.



Expansion joint section

Technical data expansion joint section	
Length:	1.800 mm
Height (PE-strips):	100 mm
Thickness (PE-strips):	10 mm
Art.-No.	91107
	PE-corrugated pipe
Length:	10 m
Art.-No.	91111

**aquatherm orange system**

**EXPANSION JOINT SECTION**

**Characteristics**

The profile rail with joint profile is cut into a suitable length and adhered to the system element.

Openings in the profile rail for the common pipe distances starting from a spacing of 50 mm.

After placing the heating pipes through the profile rail the expansion strip is placed on the pipes and the passage of the heating pipes is marked with a felt-tip pencil.

The holes have to be punched with a diameter of approx. 25 mm. The remaining web below the punched holes is cut. The protection pipes are pushed over the heating pipes in the moving area.

Finally the expansion strip is pressed over the heating pipes into the channel of the profile rail.

**Special advantages**

Larger surfaces can be divided without any problem into several partial surfaces with the aquatherm expansion joint section, if the position of the profile has been coordinated with the modular dimension of the tiles.

Further information concerning "joints" is available in leaf-lets of the Central Association of the German Building Trade.

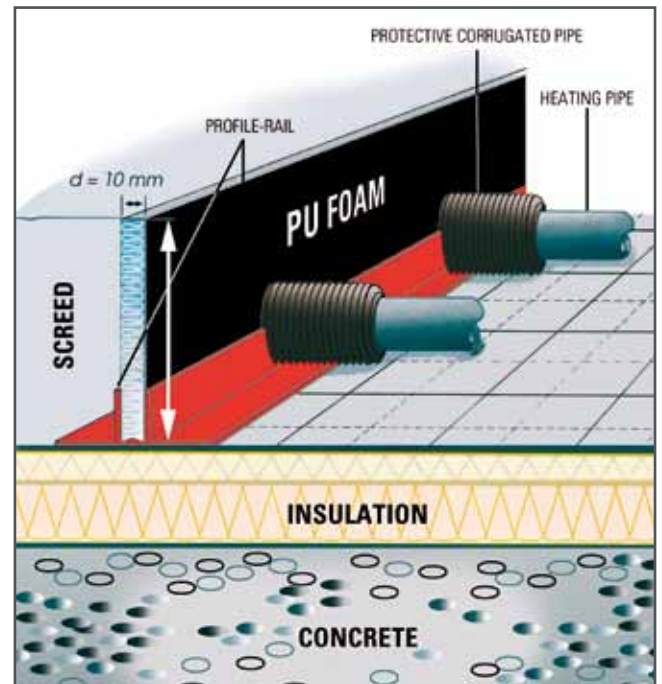

## SCREEDS

### Screed

The screed is used as a load distributing and load-carrying layer. Screeds for under floor heating must be characterized by the following:

- › high temperature resistance
- › high surface strength
- › high thermal conductivity

Screeds on aquatherm orange system -under floor heating systems must correspond to the requirements of DIN 18560.

The respective strength class is determined by the architect considering the later use.

For normal residential buildings at least cement screeds (CT) resp. floating screeds (CAF) of class F4 / F5 up to a working load of  $\leq 2.0 \text{ kN/m}^2$  have to be used.

The necessary screed thickness depending on the load can be taken from the tables 1-4 of DIN 18560 T2.

### Cement screed (CT) / screed additive

For the aquatherm orange system-under floor heating in connection with cement screed, made according to DIN 18560, the screed additive "aquatherm floor mix" is prescribed. This material has been tested in connection with the basic and additional materials of the screed.

The screed additive aquatherm orange system-"Special floor mix" is prescribed for thin-layer cement floor as per DIN 18560.

### Liquid screed (CA)

Placing of liquid screed is made without extensive compaction and distribution works. The basic materials mostly are anhydrite with addition of solvents.

As these screeds are placed in a liquid form directly on site an all-over closed surface is absolutely required.

### Calcium-sulphate liquid screed (CAF)

Calcium-sulphate liquid screed is made of anhydrite plaster, water and additional materials.

The indications of the respective manufacturer have to be considered for suitability and handling.

### Poured asphalt screed (AS)

Poured asphalt screed is made of bitumen and if necessary by adding of additional materials. The mixture is placed with temperatures of approx.  $220^\circ \text{C} - 250^\circ \text{C}$ .

Poured asphalt screeds are not suitable for aquatherm orange system-under floor heating systems.

**aquatherm orange system**

**SCREED ADDITIVE FLOOR MIX**

**Characteristics**

aquatherm orange system -floor mix is a highly efficient screed additive developed especially for heating cement floor.

Cement floors for heated floor constructions do not differ regarding their mortar composition, their mechanical preparation and the required consistency from "normal" floating laid cement floors acc. to DIN 18560, part 2.

For heated floor constructions it must be ensured, that the standard requirements for cement floors under installation condition are actually met.

The fresh cement mortar must cover the heating pipes completely and may not affect the installed materials.

aquatherm orange system -floor mix reduces the surface tension of the mixing water resulting in a better mixing of the fine grained binding agent. The result is a homogenous cement floor mortar, easy to handle, which surrounds the heating pipes completely.

The volume of mixing water is reduced by adding of aquatherm floor mix. A reduction of the water cement value (with constant mortar consistence) results in an increase of the density of the hardened floor.

By raising the density of the load distributing cement floor plate an improvement of the thermal conductivity as well as increasing heat accumulation capability are obtained.

The characteristics of fresh screed achieved by floor mix effect an increase of bending tensile and pressure stresses.

The capacity of air voids is not increased. With the aquatherm orange system -floor mix a high retaining water value of the fresh screed is achieved, that means no water separation at the cement floor surface and a reduced contraction.

**Dosage**

aquatherm orange system -floor mix must be added in a percentage of 1% of the cement weight for the completion of cement floor screed, e.g. 0.5 kg floor mix.

Add floor mix directly to the mixing water.

Proportion for cement floor thickness of 6.5 cm is approx. 0.2 kg/m<sup>2</sup>.

No further additives should be added to the aquatherm orange system-floor mix.

The addition of Estro-synthetic fibre to the fresh cement mortar can replace floor grids.



Screed additive floor mix

Technical data floor mix
Proportion: approx. 0.2 kg/m <sup>2</sup>
Art.-No. 91108

## aquatherm orange system

### SPECIAL FLOOR MIX

#### Characteristics

aquatherm orange system -special floor mix is a very efficient floor screed additive for the preparation of thin-layer and cement connected heating screed according to DIN 18560. This additive is applied for cement screeds placed on underfloor heating systems - but only in the rigidity classification.

The nominal thickness of floor screed above the heating pipes can be reduced to 30 mm on applying Special floor mix. Due to its high density and consistency the mixture of cement floor screed and Special floor mix meets all required functions of a load distributing plate, even with reduced thickness.

aquatherm orange system -special floor mix effects a substantial increase of bending tensile and pressure stress. By using this additive the cement mortar is more compressible, less mixed water is required and the result is a homogeneous structure. These characteristics of the fresh screed cause a better mixture of the fine-grained cement, a. o. by lowering the surface tension of the water. Increasing the apparent density by adding of aquatherm orange system -special floor mix effects also an increase of the thermal conductivity of the screed.

Handling, composition, preparation and curing have to be carried out acc. to DIN 18560, Part 2, Screeds and heat screeds on insulation layers. The aggregate (grave/sand 0/8 mm) must correspond to DIN 4226 "Aggregate for Concrete" with regard to its structure (a.o. grain solidity) and the grain composition of the floor aggregate to DIN 1045 "Concrete and reinforced concrete".

Processing does not differ from the previously known usual workmanship as customary machines for mixing and transport are also applied.

#### Dosiermenge

aquatherm orange system-Estrichfest-Spezial ist bei der Herstellung des Frischmörtels in einem Anteil von 10 Gewichts-% (bezogen auf das Zementgewicht) zuzugeben, das entspricht 5 kg je 50 kg Zement. Es ist unmittelbar dem ersten Anmachwasser zuzugeben. Zur Herstellung eines Heizestrichs der Festigkeitsklasse CT-F5 werden als Beispiel folgende Angaben für die erforderliche Menge von Estrichfest-Spezial gemacht:

Bei Einsatz von 320 kg Zement/m<sup>3</sup>, werden 32 kg Estrichfest-Spezial/m<sup>3</sup> verwendet.

Dies entspricht bei 1 m<sup>2</sup> Heizestrichfläche in etwa 320 g Estrichfest-Spezial pro cm Estrichdicke. Bei 30 mm Estrichüberdeckung (Gesamtdicke des Estrichs ca. 45 mm) entspricht dies einer Menge von 1,45 kg/m<sup>2</sup>.

#### Verarbeitung

Beim Einsatz von „Werksfrischmörtel“ muss die Estrichkonsistenz im Anlieferungszustand steif sein. Die Zugabe von Estrichfest-Spezial erfolgt auf der Baustelle, direkt in den Fahrmixer. Das Nachmischen im Fahrzeug von etwa 10 Minuten ist unbedingt erforderlich, um die Wirkungsweise von Estrichfest-Spezial voll auszuschöpfen. Sollte dem Werksfrischmörtel ein Betonverzögerer beigemischt werden, ist unbedingt Rücksprache mit der Firma aquatherm erforderlich.

Dem Estrich dürfen keine anderen Zusatzmittel beigemischt werden. Estrichmörtel dürfen nach DIN 18560, Teil 1, nicht unter +5 °C verarbeitet



Screed additive "Special floor mix"

Technical data special floor mix
Proportion: approx. 1.45 kg/m <sup>2</sup>
Art.-No. 91110

werden. Da der zusätzliche fachgerechte Einbau z.B. eines Estrichgitters als Bewehrung bei dünnenschichtigen Estrichen handwerklich sehr schwierig ausführbar ist, wird empfohlen, dem Frischmörtel Estro-Kunstfasern (Produktinformation anfordern!) zuzugeben. Heizestriche müssen vor dem Verlegen von Bodenbelägen aufgeheizt werden. Die Inbetriebnahme (Aufheizung) muss entsprechend der aquatherm orange system-Montageanleitung durchgeführt werden.

**aquatherm orange system**

**SCREED MEASURING POINT**

**Characteristics**

Cement and anhydrite screeds must be heated prior to placing of floor coverings acc. to DIN EN 1264.

Suitable measuring points in the heating area are necessary for determination of the content of humidity. At least 3 measuring points per each 200 m<sup>2</sup> resp. per flat are required.

Detailed information regarding the heating on page Heat-up of screed!

**Important intersecting points**

**Planning: Planner Heating / Architects**

The planner - in coordination with the architect - determines the number and position of the intersection points in the plan.

If no planner is involved, the client or his desputy takes on the task.

**Design: Screed layer**

The screed layer installs the intersecting points acc. to the plans.

**Measuring: Chief of the covering placing**

The measuring is carried out by means of a CM-device before placing the covering.

**Important!**

The minimum distance between heating pipe and intersection point is 100 mm.

**Screed fields**

In case of non-rectangular floor surfaces or coved surfaces the required expansion joints have to be arranged in such a way that possibly cramped fields result. The thermally caused change of length of the cement screed amounts to approx. 0.012 mm / mK. Taking up of pressure and tensile stress can only be achieved by correctly planned and installed expansion joints and screed fields. The planner of the building has to issue a joint plan regarding the arrangement of joints which has to be presented to the executing party as part of the performance description.

**Edge Gaps**

Edge gaps take up thermally caused changes of length of the screed and floor coverings. They reduce the impact sound transmission from the floor to other components. Edge gaps must enable a movement space of at least 5 mm. The edge insulation in the edge gap may only be cut after completion of the floor covering. Subsequently the edge gaps have to be filled with an elastic joint seal.



Screed measuring point

Techical data screed measuring point	
Height: 100 mm	
Art-No. 91109	

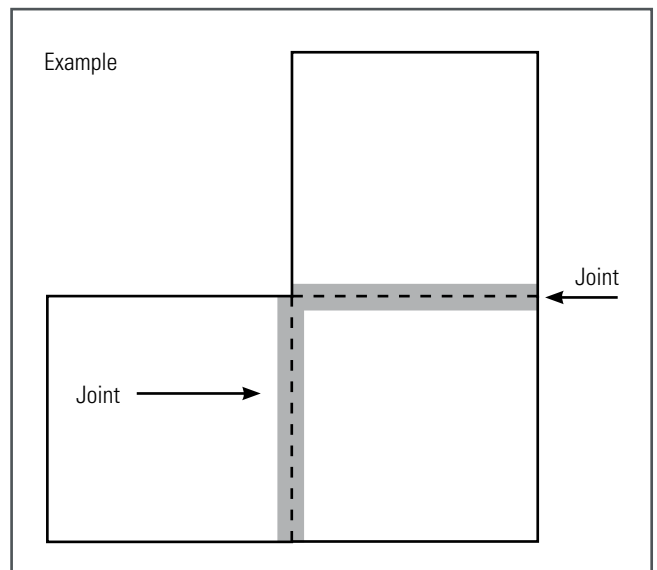

## MOVEMENT JOINTS / DUMMY JOINTS

### Movement joints

In case of cement screeds designated for stone or ceramic coverings with surface sizes starting from approx. 40 m<sup>2</sup>, screed fields should be constructed separately by using aquatherm orange system-expansion joint profiles. The expansion joint profile is supplied as a complete set consisting of T-profiles and expansion strips made of PE. The side length of single floor fields should not exceed 8 m. The side ratio may not be larger than 1:2. Movement joints are joints in the screed separating completely up to the insulation layer. Heating pipes may only cross those movement joints as connection ducts. In this case the pipes must be protected with the aquatherm orange system corrugated pipes (approx. 30 cm). Movement joints must run congruently starting from the insulation layer up to the covering. After completion of the covering the movement joints have to be closed with an elastic joint seal on the upper side. Movement joints should be placed in case of heating screed in door sills and for tiles and ceramic coverings between different heated circuits within one heating field.

### Dummy joints

Dummy joints are predetermined breaking points for the abbreviation of screed. The trowel indent is made in the fresh screed mortar. The arrangement of dummy joints is applied where movement joints are not required but where tensions of the screed plate should be transferred.

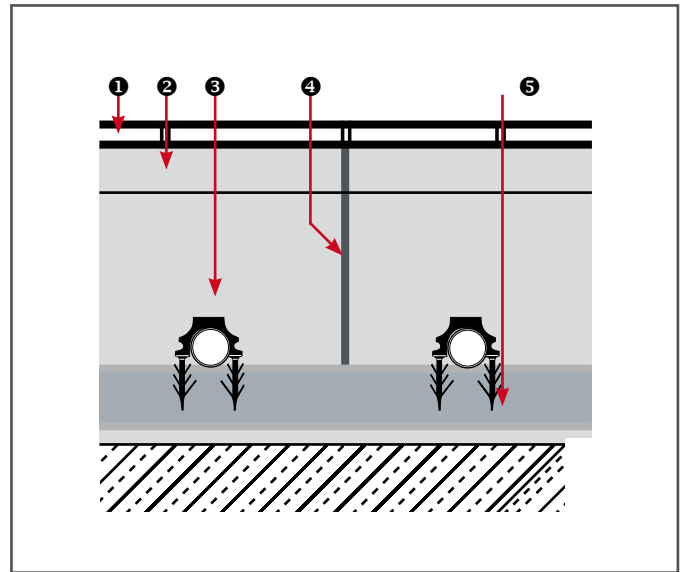

- ❶ Stone covering
- ❷ Mortar bed
- ❸ Cement screed
- ❹ Movement joint
- ❺ Heat-impact sound insulation

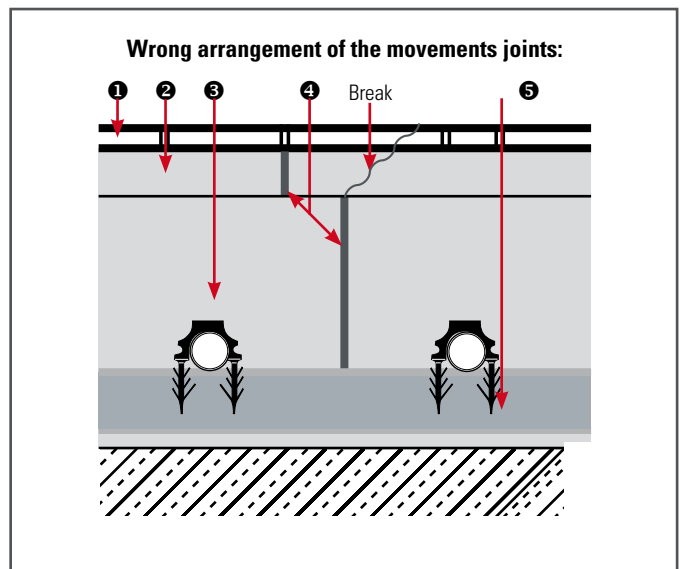

## FLOOR REINFORCEMENT / PROCEDURES FLOOR COVERINGS

### Floor reinforcement

Reinforcement of screeds on insulation layers is generally not necessary.

However for cement floors with stone or ceramic coverings same is useful, as an enlargement of possibly resulting cracks and the displacement height of the cracked edges can be avoided.

The reinforcement has to be made with reinforcing steel meshes with a mesh width of 150 mm x 150 mm or with reinforcing steel meshes with the following parameters:

Mesh width	Diameter	Rigidity
50 mm x 50 mm	2 mm	700 N/mm <sup>2</sup>
75 mm x 75 mm	3 mm	700 N/mm <sup>2</sup>
100 mm x 100 mm	3 mm	500 N/mm <sup>2</sup>

The reinforcement has to be interrupted in the range of movement joints and to be arranged in approx. the middle third of the thickness of the screed.

The reinforcement meshes must never be pushed through the edge insulation.

Floor reinforcements must be free from edges to avoid mechanical damage of the pipes.

Principally reinforcing steel meshes will never prevent cracking of the heating screed. Reinforcing steel meshes have to be protected against corrosion, especially on using anhydrite screed.

As the professional installation of reinforcing steel meshes with thin-layer screeds is rather difficult, it is recommended to add screed synthetic fibres for this type of screed.

### Procedures floor coverings

#### Thin mortar bed technique

With the thin mortar bed technique coverings are glued together with a suitable bonding agent on the screed.

Only products indicated by the manufacturer may be used.

#### Thick mortar bed technique

With the thick mortar bed technique the stone floors are placed directly in the mortar. The thickness of the mortar depends on the used stone covering.

The minimum thickness is 15 mm.

#### Placing with fresh screed

Large-surface stone plates can be beaten directly in the mortar bed. The advantage of this type of placing surely is the fact that different thickness of the covering can be levelled.

The full mortar bed has to be mixed with aquatherm orange system-screed additive.

## FLOOR COVERINGS / CONDITIONS FOR PLACING

### Floor coverings

The following types of covering are suitable for the aquatherm orange system-underfloor heating:

- ceramic tiles and plates
- natural stone (marble, etc.)
- elastic coverings (e.g. PVC-floor)
- textile coverings (carpet floor)
- parquet / laminate

### Thermal resistance

The thermal resistance as per DIN EN 1264 for surface coverings is 0.15 m<sup>2</sup> K/W. The respective installation instructions, standards resp. regulations for the individual types of covering have to be considered.

### Conditions for placing

- The following conditions must be fulfilled prior to placing of the selected surface covering:
- The screed has been heated acc. to the aquatherm orange system-installation instructions.
- The flow temperature has to be kept until the moisture content equilibrium of the table has been reached.
- All edge joints and movement joints have been checked on correct arrangement and execution.
- Remaining solid matters (e.g. mortar remains) have been removed completely.

### Working material

Only such materials may be used as priming materials, fillers, adhesives / cement and thin bed mortar as indicated by the manufacturer to be "suitable for underfloor heating systems". The manufacturer has to guarantee the heat aging stability. Thin bed mortar and adhesives must be resistant to a permanent temperature up to 50° C and also compensate permanently different heat expansions of the screed and the surface covering. Textile surface coverings must be glued all-over the surface and have to be provided by the manufacturer with the supplement "suitable for underfloor heating systems".

## HEATING OF SCREED / MOISTURE CONTENT EQUILIBRIUM

### Heating of screed

Anhydrite and cement screeds must be heated prior to placing of floor coverings. When switching off the floor heating after the heating phase the screed has to be protected against draft and rapid chilling.

Differing from the method of other hot-water heating systems the cement screed should be heated after 21 days at the earliest and the anhydrite screed according to the indications of the manufacturer, however after 7 days at the earliest.

The first heating starts with a flow temperature of 25° C, which has to be kept for 3 days. Afterwards the maximum flow temperature is adjusted and kept for another 4 days. It is not quite guaranteed that after the described heating procedure the screed has reached the moisture content necessary to be ready for placing.

### REMARK:

The table below contains reference values for being ready for placing, measured with a CM-unit (moisture tester) at approx. 20° C room temperature.

### Moisture content equilibrium

Prior to placing of the floor covering the screed must have reached the moisture content equilibrium acc. to the following table.

The moisture content equilibrium must be checked by the company placing the floor covering. There must be 3 measuring points per 200 m<sup>2</sup> resp. per flat.

### Decisive maximum moisture content of screeds for readiness for placing the floor coverings

Floor covering	Moisture content cement screed	moisture content calcium sulphate
Elastic floor coverings e.g. PVC rubber, lino	1,8 %	0,3 %
Textile coverings	1,8 %	0,3 %
Parquet/Cork	1,8 %	0,3 %
Laminate	1,8 %	0,3 %
Stone and ceramic coverings in thick bed	2,0 %	-
Stone and ceramic coverings in thin bed	2,0 %	0,3 %

## STARTING RECORD OF AQUATHERM-HOT WATER UNDERFLOOR HEATING ACC. TO DIN EN 1264, PART 4

Project \_\_\_\_\_  
 Street \_\_\_\_\_  
 PC/ City \_\_\_\_\_  
 Part of the plant aquatherm system  Roll 35-3  knob plate F ND 35-3  knob plate FND 11  aluminium grid

### 1. Leak test

The tightness of the circuits is checked by a water pressure test directly before laying the screed. Then the working pressure is adjusted and kept. The test pressure must be the 1.3 fold of the maximum permissible working pressure, but at least 1 bar overpressure.

Max. permissible working pressure \_\_\_\_\_  
 Test pressure \_\_\_\_\_  
 Load duration \_\_\_\_\_

The tightness has been ascertained; no remaining form changes at any component.

Advice: Adjustment of the aquatherm orange system-heating circuit valves after flushing of the system.

### 2. Functional heating for calcium sulphate screed and cement screed

The perfect function of the heated floor construction is checked by the functional heating.

- › With cement screed it can be started 21 days after finishing the screed works at the earliest
- › With calcium-sulphate screed after 7 days at the earliest (acc. to manufacturer's indication)

Type of screed / product  cement screed  calcium-sulphate screed  
 Used fixing agent  screed additive  screed additive "Special"  
 Conclusion of screed works \_\_\_\_\_ Date  
 Start of functional heating \_\_\_\_\_ Date

(The constant flow temperature of 25° C has to be kept for 3 days.)

Adjustment of maximum flow temperature of \_\_\_\_\_ °C \_\_\_\_\_ Date

(The max. flow temperature (follow manufacturer's instructions) must be kept for 4 days).

End of the functional heating \_\_\_\_\_ Date

Attention: the functional heating does not guarantee, that the screed has the right moisture content for the readiness for placing the floor coverings.

The functional heating has been interrupted  no  yes from \_\_\_\_\_ until \_\_\_\_\_

The rooms have been aerated without draught and all windows / outside doors have been closed after switching off the floor heating. The heated floor surface was free from construction material and heavy coverings. The plant has been released for further constructions at an outside temperature of

- The plant was out of action
- The floor has been heated with a flow temperature of \_\_\_\_\_ °C beheizt.

Confirmation (date/stamp/signature)

\_\_\_\_\_  
Owner/Client

\_\_\_\_\_  
Constructor/Architect

\_\_\_\_\_  
Heating engineer

## REGULATIONS / DECREES / LAWS

The following laws, decrees, instructions and standards have to be considered for planning and installation of heating systems:

- › energy saving law (EnEG)
- › energy saving regulation - EnEV

### Heating technology

- › DIN 1961 Contract procedure for building works B and C
- › DIN 4102 Fire protection
- › DIN 4108 Thermal insulation in high buildings
- › DIN 4109 Sound insulation in high buildings
- › DIN EN 12831 Heating systems in buildings, procedure for calculation of standard heat charge
- › DIN EN 1264 Hot-water underfloor heating systems
- › DIN EN 1264 Pipelines of plastic for hotwater floor heating systems
- › DIN 4751 Safety equipment of hot-water heating systems
- › DIN18380 Heating and service water heating systems

## CALCULATION

In general an exact heat requirement calculation as per DIN 4701 has to be made prior to the design of an aquatherm orange system-underfloor heating system. The calculation of the pipe distances is made in accordance with the performance output characteristics of the single pipe distances.

The surface covering should be known when planning. In objects for which the covering will be determined afterwards, the most unfavourable but still allowable covering should be planned. Same is also valid for rooms, in which a change of covering is to be expected later on.

In rooms with stone coverings experience showed that the floor will usually be covered with rugs, carpets etc. Due to this a correction of the planning is necessary.

### Floor surface temperature

The following floor surface temperatures should not be exceeded for physiological and medical reasons:

- 29° C in rooms (domestic and office buildings)
- 35° C in edge areas
- 33° C in bathrooms and indoor swimming pools.

When calculating the rooms, it should be checked if the max. allowed floor temperature is kept by the selected pipe distance.

For rooms in which the specific heat requirement does not guarantee the compliance of the surface temperature any longer, planning of additional heating surfaces should be considered. The fact that the standard-outside temperature as indicated in DIN 4701 only occurs on a few days shows that the actual floor surface temperature is considerably below the theoretically determined values.

### Basis of calculation

The following documents are required to calculate the aquatherm orange system-underfloor heating system:

- > the complete constructional drawings
- > the standard heat requirement calculation as per DIN EN 12831
- > the output characteristics of the pipe distances
- > the pressure loss diagrams of the valves
- > the pressure loss diagram of the heating pipes

When designing the rooms the adjusted heat requirement  $\Phi_{Ber}$  [W] can be taken into account and is calculated as follows:

$\Phi_N$	standard heat load
-	$\Phi_{FB}$ heat flow through the floor
-	$\Phi_{Ber}$ adjusted heat requirement [W]

The standard heat load  $\Phi_{HL}$  is decisive for the design of the boiler and the calculation of the water quantity. The adjusted specific heat requirement  $q_h$  [W/m<sup>2</sup>] is calculated according to the following formula:

$q_h = \frac{\Phi_{Ber} \text{ adjusted heat load [W]}}{A_R \text{ room surface [m}^2\text{]}}$
---

### Method of calculation

The method of calculation is made as per DIN EN 1264. The surface temperature is limited in accordance with the respective design area. The return temperature is limited variably to at least  $\theta_i + 2^\circ$  C for every room so that a hydraulic room adjustment is possible.

### Connection supplies

Connection supplies are pipes between the manifold and the circuit.

If the connection supplies are running through another room with an individual circuit they must have an identical pipe distance acc. to the surface design. These continuous connection supplies can be designed with the same thermal output as the circuit. For determination of the total circulating water quantity the continuous connection length must be corrected correspondingly.

### Edge areas

Pipes in edge areas can be laid in closer distances as these areas are not used so frequently. The surface temperatures may be higher compared to the occupied zone. Higher heat losses e.g. due to large-surface glasses can be considered and compensated.

## CALCULATION

The width of edge areas should not exceed 1.0 m. More-over, edge areas should be placed all-over the outside wall in which the window is arranged.

In case that the pipe spacing in the occupied zone is PS 100 or PS 150 the pipe spacing (PS) of the edge area should be PS 75. For a pipe spacing of PS 200 to PS 300 same should be PS 100.

If the edge area has to produce extremely high heating output, a PS 50 is recommended. In general the edge area should be designed as an independent heating circuit, i.e. with an own connection supply.

For small rooms with a condensed perimeter zone the integrated design should be selected, i.e. condensed perimeter zone area and occupied zone are laid as a combined heating circuit.

### Occupied zone

The occupied zones are laid according to the calculated pipe spacing. Pipe spacings of more than 30 cm are only allowed in exceptional cases due to the high differences of the floor surface temperatures.

#### **Kitchen:**

As during the planning phase the covered surface is in most cases not known due to built-in furniture, a minimum PS of 150 should be planned and laid (considering the max. allowed surface temperature). Voids below built-in furniture should be avoided if possible.

#### **Baths:**

In bathrooms, toilet areas and going round areas of swimming pools a pipe spacing of at least PS 100 mm has to be planned and laid (considering the maximum allowed surface temperature) as a direct foot contact is most frequently here.

## FLOOR SURFACE COVERINGS / SYMBOLS / RUGS

### Floor surface coverings

Floor surface coverings have an important influence on the heat flux density of underfloor heating systems. The thermal resistance of floor coverings depends on the nature of the materials.

The maximum temperature delay of floor coverings is  $R_{\lambda,B} = 0,15 \text{ m}^2 \text{ K/W}$ . For carpets the temperature delay of the floor and the possibly used sub layer must be added.

### Standard values for surface coverings

<b>tiles</b>	approx. 0,01- 0,02 $\text{m}^2 \text{ K/W}$
<b>marble</b>	approx. 0,01- 0,025 $\text{m}^2 \text{ K/W}$
<b>carpet</b>	approx 0,05- 0,15 $\text{m}^2 \text{ K/W}$
<b>parquet / laminate</b>	approx. 0,035- 0,150 $\text{m}^2 \text{ K/W}$
<b>PVC, lino</b>	approx. 0,025- 0,075 $\text{m}^2 \text{ K/W}$

### Symbols "suitable for underfloor heating systems"

Carpeted floors and elastic layers which are suitable for placing on under floor heating systems are provided with a corresponding symbol by the manufacturer



carpets



elastic coverings

### Use of rugs

If loose carpets or rugs are placed on stone floors, PVC, parquet or laminate the medium thermal resistance  $R_{\lambda,B}$  has to be determined in accordance with the surface interest using the following formula.

$$R_{\lambda,Bm} = \frac{A_{Ges} \cdot R_{\lambda,0} + A_B \cdot R_{\lambda,T}}{A_{Ges}}$$

$R_{\lambda,B}$  = medium thermal resistance

$A_{Ges}$  = total surface

$A_B$  = surface covered with loose carpet

$R_{\lambda,0}$  = thermal resistance surface covering

$R_{\lambda,T}$  = thermal resistance carpet

### Calculation example:

medium thermal resistance

#### Example:

30,0  $\text{m}^2$  stone tiles  $R_{\lambda,0} = 0,02 \text{ m}^2 \text{ K/W}$  covered with

10,0  $\text{m}^2$  carpets  $R_{\lambda,T} = 0,10 \text{ m}^2 \text{ K/W}$

#### Result:

$$R_{\lambda,Bm} = \frac{30 \text{ m}^2 \cdot 0,02 \text{ m}^2 \text{ K} + 10 \text{ m}^2 \cdot 0,1 \text{ m}^2 \text{ K}}{W \quad 30 \text{ m}^2 \text{ W}}$$

$$R_{\lambda,Bm} = 0,053 \text{ m}^2 \text{ K/W}$$

## LENGTH OF HEATING CIRCUIT / AREA OF MANIFOLD CONNECTION / MATERIAL REQUIREMENTS

### Heating circuit length

The maximum allowed heating circuit length for aquatherm orange system-underfloor heating systems depends on the pipe dimension applied.

14 x 2.0 mm = max. heating circuit length = 100 m  
 16 x 2.0 mm = max. heating circuit length = 120 m  
 17 x 2.0 mm = max. heating circuit length = 125 m  
 20 x 2.0 mm = max. heating circuit length = 160 m

Rooms in which the design requests greater pipe lengths should be divided into several heating circuits - if possible - of the same length, in order to guarantee a hydraulic compensation of the heating system. It should be considered that even for heating circuits up to a maximum length a partition into 2 heating circuits is necessary, if the pressure loss exceeds 350 mbar.

### Manifold connection area

All feed pipes in front of the manifold are placed close together. As these connection pipes also convey heat it might be possible that the surface

temperature is higher than the allowed value.

In this case a respective number of connection pipes should be insulated.

### Material requirements

The bill of quantity of the aquatherm system components can be made in accordance with the following table.

Material requirements		A 50	VA 75 <sup>1</sup>	VA 100	VA 150	VA 200	VA 250	VA 300
Heating pipe	m	A x 19,0	A x 12,5	A x 9,5	A x 6,25	A x 5,0	A x 4,0	A x 3,5
Pipe clips <sup>2</sup>	Pc	A x 40,0	A x 25,0	A x 20,0	A x 15,0	A x 10,0	A x 8,0	A x 7,0
Alternatively for pipe clips: spring rail <sup>3</sup>	m	A x 1,0	A x 1,0	A x 1,0	A x 1,0	A x 1,0	A x 1,0	A x 1,0
Edge insulation	m	A x 1,0	A x 1,0	A x 1,0	A x 1,0	A x 1,0	A x 1,0	A x 1,0
Screed additive	kg	A x 0,15	A x 0,15	A x 0,15	A x 0,15	A x 0,15	A x 0,15	A x 0,15
Screed additive special floor mix	kg	A x 1,45	A x 1,45	A x 1,45	A x 1,45	A x 1,45	A x 1,45	A x 1,45
System elements	m <sup>2</sup>	A x 1,0	A x 1,0	A x 1,0	A x 1,0	A x 1,0	A x 1,0	A x 1,0

A: heating surface [m<sup>2</sup>]

PS: pipe spacing [mm]

<sup>1</sup> Pipe spacing 75 mm is not possible when using the system element knob plate

<sup>2</sup> Pipe holder devices are not necessary when using the system element knob plate

<sup>3</sup> Spring rail is not suitable for the system element knob plate

## THERMAL OUTPUT AS PER DIN EN 1264

### Thermal output as per DIN EN 1264

Until now the selection of the laying distances has been made in accordance with the thermal output of the respective system supplier.

A comparison of suppliers with the same system constructions was nearly impossible due to different data of power. With DIN EN 1264 a uniform calculation procedure has been introduced enabling to determine the power data of all underfloor heating systems. Power differences of comparable systems with the same construction are not longer possible.

The thermal output of a underfloor heating system in the wetlaying procedure can be calculated based on the following formula:

$$\dot{q} = B \cdot a_B \cdot a_T^{m_T} \cdot a_U^{m_U} \cdot a_D^{m_D} \cdot \Delta\vartheta_H$$

Explanation:

B	influence of the pipe material, the pipe wall thickness and a possible pipe shell on the heat flux density
$a_B$	factor of the floor covering
$a_T$	division factor (pipe distance)
$a_U$	covering factor
$a_D$	factor of the external diameter of the pipe
$\Delta\vartheta_H$	Heizmittelübertemperatur
$m_T$	$1 - \frac{T}{0,075}$ (valid f. pipe systems $0,050 \leq T \leq 0,375$ m)
$m_U$	100 (0,045 m - Sü) (valid f. pipe coverings Sü $\leq 0,015$ m)
$m_D$	250 (D - 0,020 m) valid f. pipe diameters $0,012 \text{ m} \leq D \leq 0,030$ m

aquatherm orange system-underfloor heating systems correspond to the system construction A and C as per DIN EN 1264-1.

Using (CT) cement screed of class F4 for vertical load > 2.0 kN/m<sup>2</sup> screed thickness of 45 mm (plus outside diameter of heating pipe) has to be considered.

The specific outputs for the individual system constructions can be gathered from the tables on 165-190.

The performance characteristic describes the connection between the heat output  $q$  and the required excess temperature of the heating means  $\Delta\vartheta_H$ , whereas the temperature delay for four floor coverings has been considered also.

The excess temperature for the heating means  $g\vartheta_H$  is calculated as a logarithmic means from the flow temperature  $\vartheta_v$ , the return temperature  $\vartheta_r$  and the room temperature  $\vartheta_i$ . Consequently the influence of the temperature difference has been determined.

$$\Delta\vartheta_H = \frac{\vartheta_v - \vartheta_r}{\text{Ln} \frac{\vartheta_v - \vartheta_i}{\vartheta_r - \vartheta_i}}$$

## FLOW TEMPERATURE / DIN CERTCO REGISTRATION

### Flow temperature

Upon determination of the flow temperature a temperature delay of the floor covering of  $R_{\lambda, B} = 0.10 \text{ m}^2 \text{ K/W}$  is assumed in accordance with the standards for recreation rooms.

For bath  $R_{\lambda, B} = 0,00 \text{ m}^2 \text{ K/W}$ .

The temperature difference of the heating circuit in the most unfavourable room is max. 5 K. The other rooms have larger differences depending on the heat requirement, pipe distance, floor covering and excess temperature of the heating means. Consequently the medium heat flow of a complete system is determined as a mixed value of the medium heat flow of all heating circuits and can not be calculated with a predicted difference.

By the limitation of the floors' surface temperature limit values of the heat flux density arise depending on the floor surface. These limiting curves are drawn in the graphs and **must not be exceeded**.

The flow temperature  $\vartheta_{V, \text{Ausl.}}$  is calculated as follows:

$$\vartheta_{V, \text{Ausl.}} = \vartheta_i + \Delta \vartheta_{H, \text{Ausl.}} + \frac{\sigma}{2}$$

If the ratio is  $\sigma/\Delta\vartheta_H > 0.5$  the flow temperature has to be calculated as follows:

$$\vartheta_{V, \text{Ausl.}} = \vartheta_i + \Delta \vartheta_{H, \text{Ausl.}} + \frac{\sigma}{2} + \frac{\sigma^2}{12\Delta \vartheta_{H, \text{Ausl.}}}$$

For all remaining rooms operated with the flow temperature the respective expansions have to be calculated according to the following formula: ...

$$\sigma_j = 2 \cdot [(\vartheta_{V, \text{Ausl.}} - \vartheta_i) - \Delta \vartheta_{Hj}]$$

...as far as the ratio is  $\sigma_j / g\vartheta_H \leq 0.5$ .

At a ratio of  $\sigma_j / g\vartheta_H \leq 0.5$  the differences are calculated as follows:

$$\sigma_j = 3 \cdot \Delta \vartheta_{Hj} \sqrt{1 + \frac{4 (\vartheta_{V, \text{Ausl.}} - \Delta \vartheta_{Hj})}{3 \cdot \Delta \vartheta_{Hj}}} - 1$$

### DIN CERTCO registration

DIN CERTCO gave the allowance to mark with the following register-no.:

For insulation roll:

**7F296-F**

For TS 25 with dry floor screed (TE):

**7F297-F**

For surface elastic sports floors:

**7 F 291-F**

**7 F 292-F**

**7 F 293-F**

**7 F 294-F**

**7 F 295-F**

**7 F 298-F**

**PRESSURE LOSS GRAPHS**

Pressure loss graph for aquatherm orange system pipes  
 14 x 2 mm, 16 x 2 mm, 17 x 2 mm and 20 x 2 mm

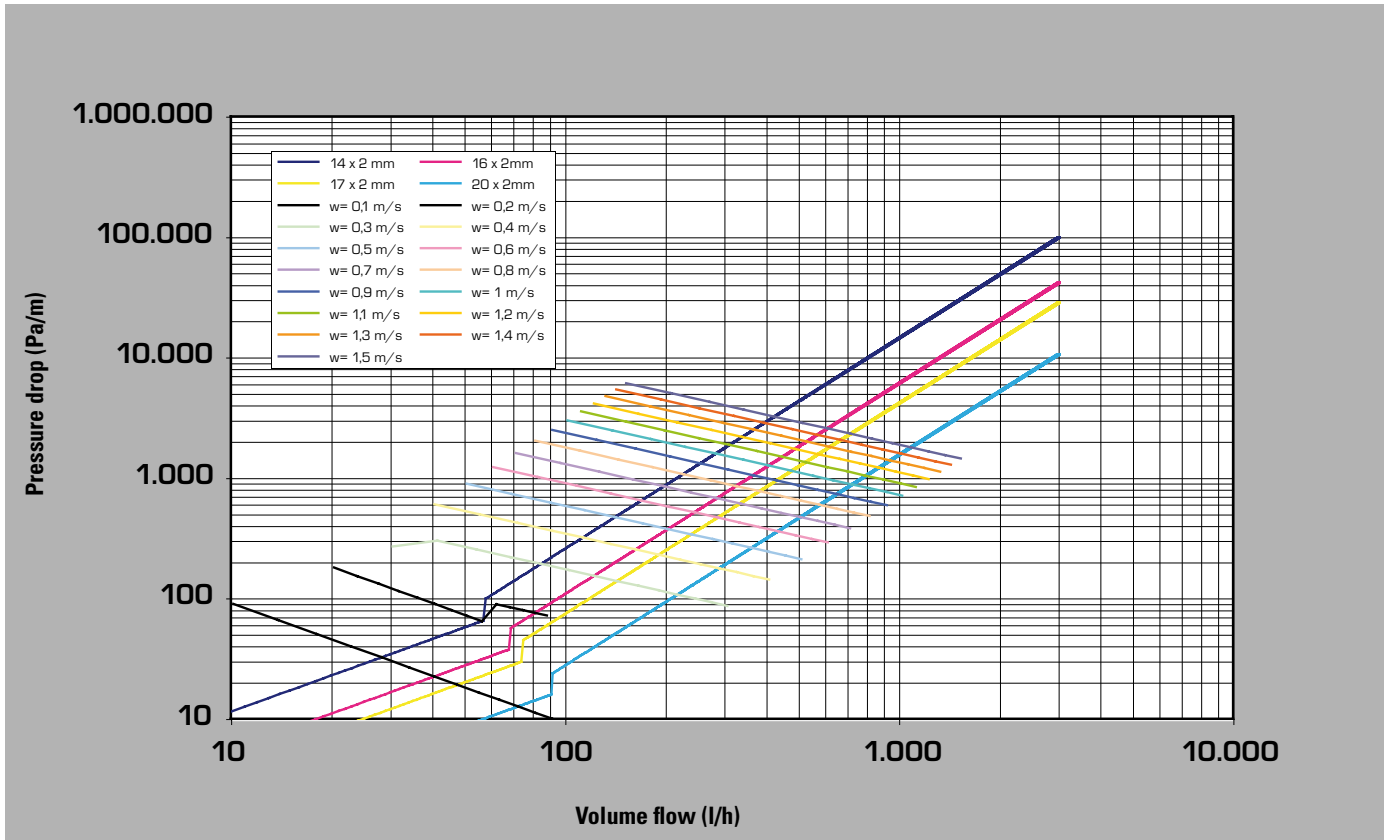

### GRAPH OF HEAT OUTPUT

Graphs of heat output valid for heating pipe 16 x 2 mm with 45 mm screed covering with a pipe spacing PS of 75 mm

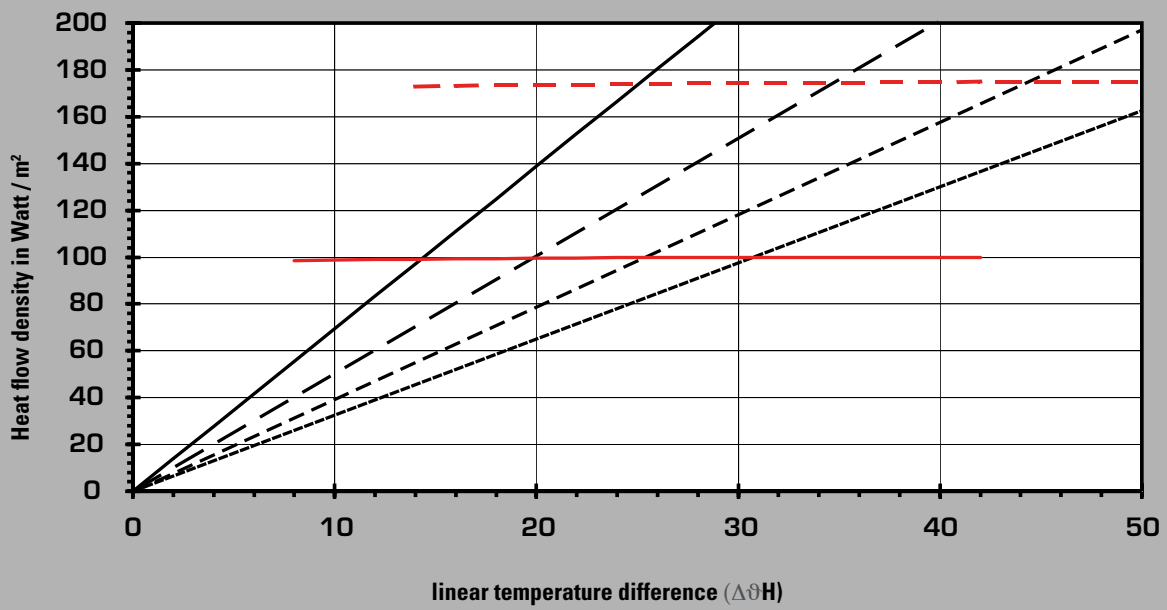

Thermal resistance of surface covering



- 0,00 m²K/W
  0,05 m²K/W
  0,10 m²K/W
- 0,15 m²K/W
  limiting curve dT:9K
  limiting curve dT: 15K

## GRAPH OF HEAT OUTPUT

Graphs of heat output valid for heating pipe 16 x 2 mm with 45 mm screed covering with a pipe spacing PS of 100 mm

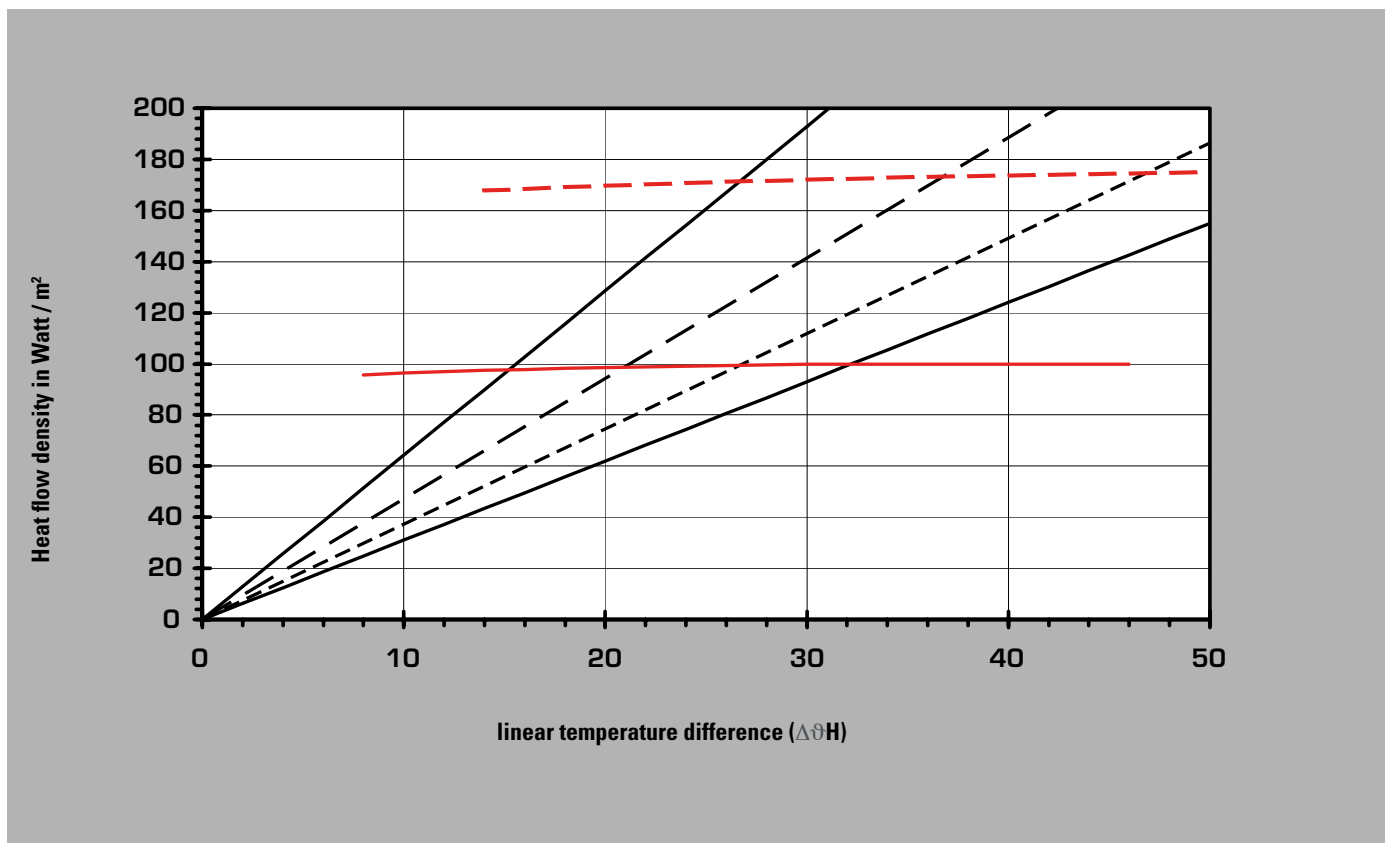

Thermal resistance of surface covering

- |       |            |           |                      |             |                          |
|-------|------------|-----------|----------------------|-------------|--------------------------|
| ————— | 0,00 m²K/W | - - - - - | 0,05 m²K/W           | - · - · - · | 0,10 m²K/W               |
| ····· | 0,15 m²K/W | —————     | limiting curve dT:9K | - - - - -   | limiting curve : dT: 15K |



### GRAPH OF HEAT OUTPUT

Graphs of heat output valid for heating pipe 16 x 2 mm with 45 mm screed covering with a pipe spacing PS of 150 mm

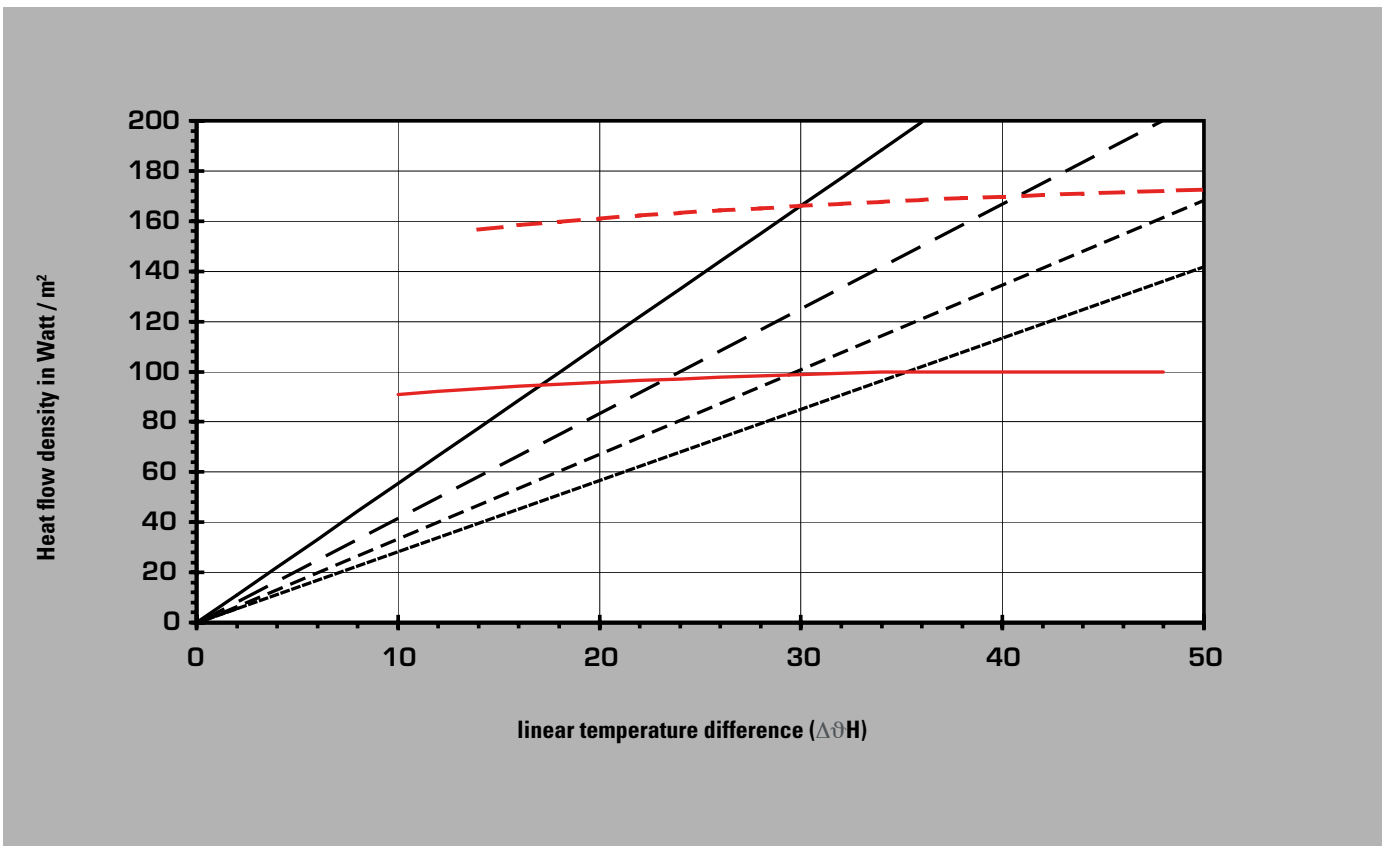

Thermal resistance of surface covering

— 0,00 m²K/W  
 - - - 0,15 m²K/W

- - - 0,05 m²K/W  
 - · - · - 0,10 m²K/W

- · - · - 0,10 m²K/W  
 — limiting curve dT:9K  
 - - - limiting curve dT: 15K



## GRAPH OF HEAT OUTPUT

Graphs of heat output valid for heating pipe 16 x 2 mm with 45 mm screed covering with a pipe spacing PS of 200 mm

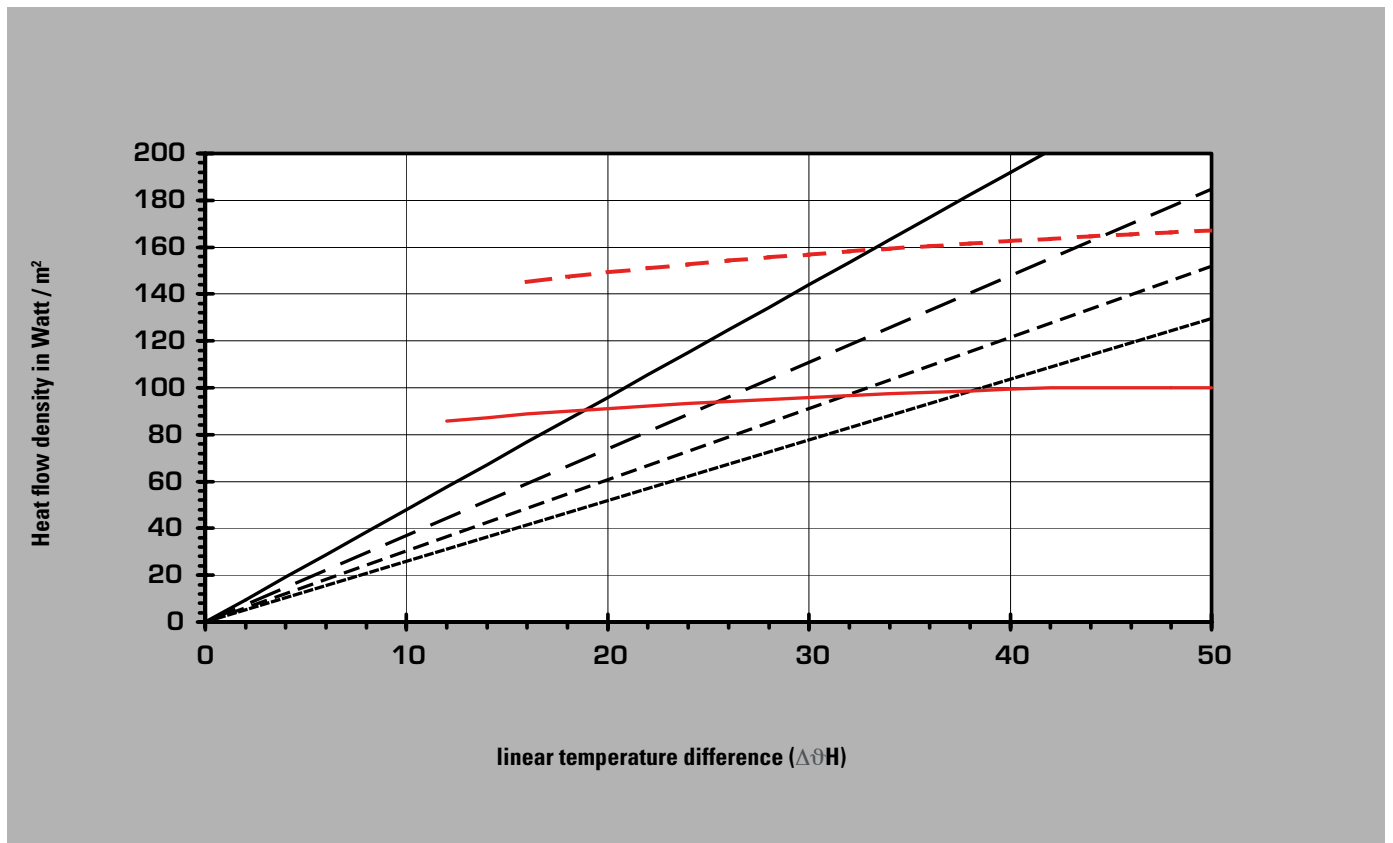

Thermal resistance of surface covering

— 0,00 m<sup>2</sup>K/W  
 - - - 0,15 m<sup>2</sup>K/W

- - - 0,05 m<sup>2</sup>K/W

- · - · 0,10 m<sup>2</sup>K/W

— limiting curve dT: 9K

- - - limiting curve dT: 15K



### GRAPH OF HEAT OUTPUT

Graphs of heat output valid for heating pipe 16 x 2 mm with 45 mm screed covering with a pipe spacing PS of 250 mm

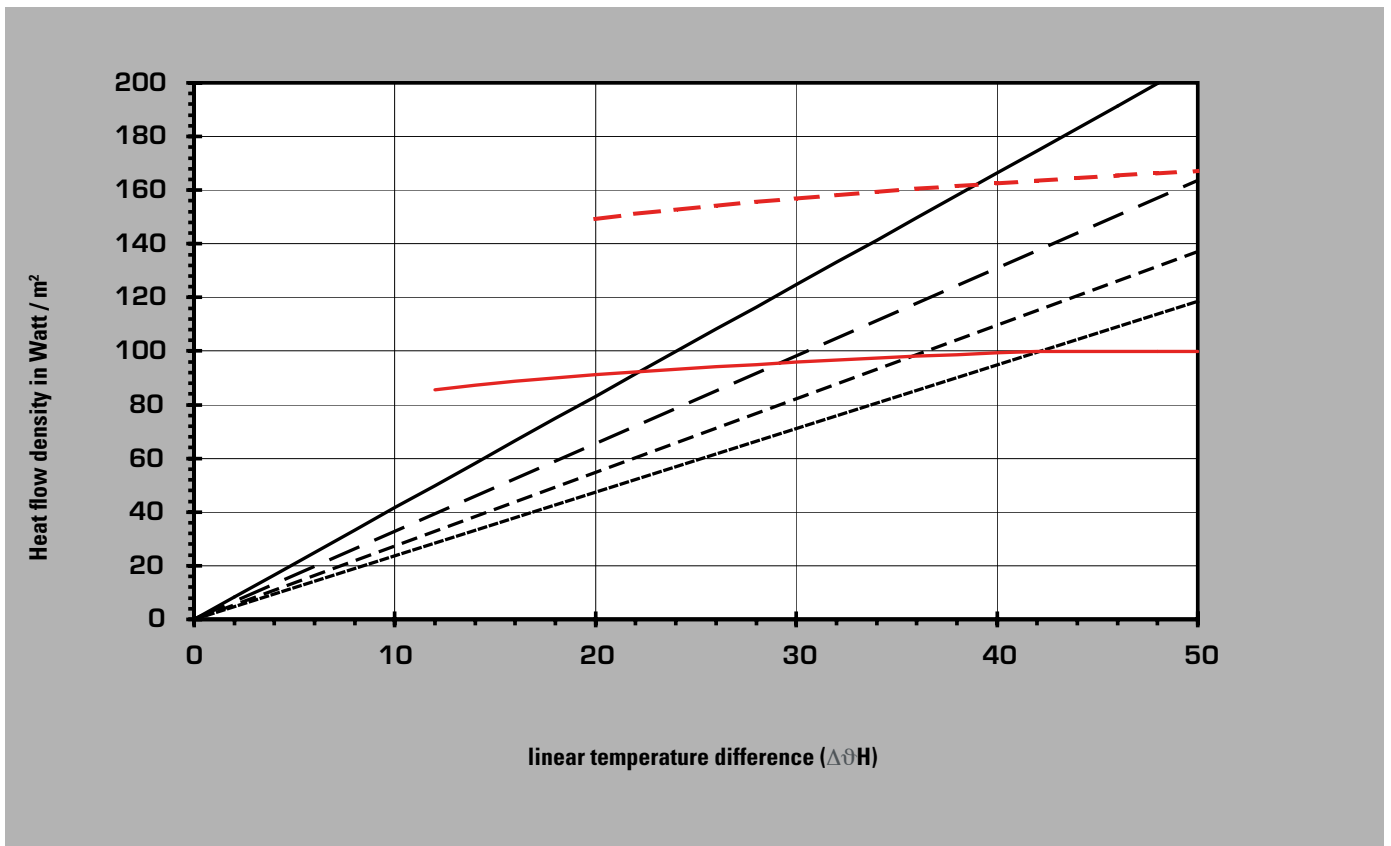

Thermal resistance of surface covering

- 0,00 m²K/W
- - - 0,05 m²K/W
- · - · - 0,10 m²K/W
- · · · · 0,15 m²K/W
- limiting curve ΔT: 9K
- - - limiting curve ΔT: 15K



## GRAPH OF HEAT OUTPUT

Graphs of heat output valid for heating pipe 16 x 2 mm with 45 mm screed covering with a pipe spacing PS of 300 mm

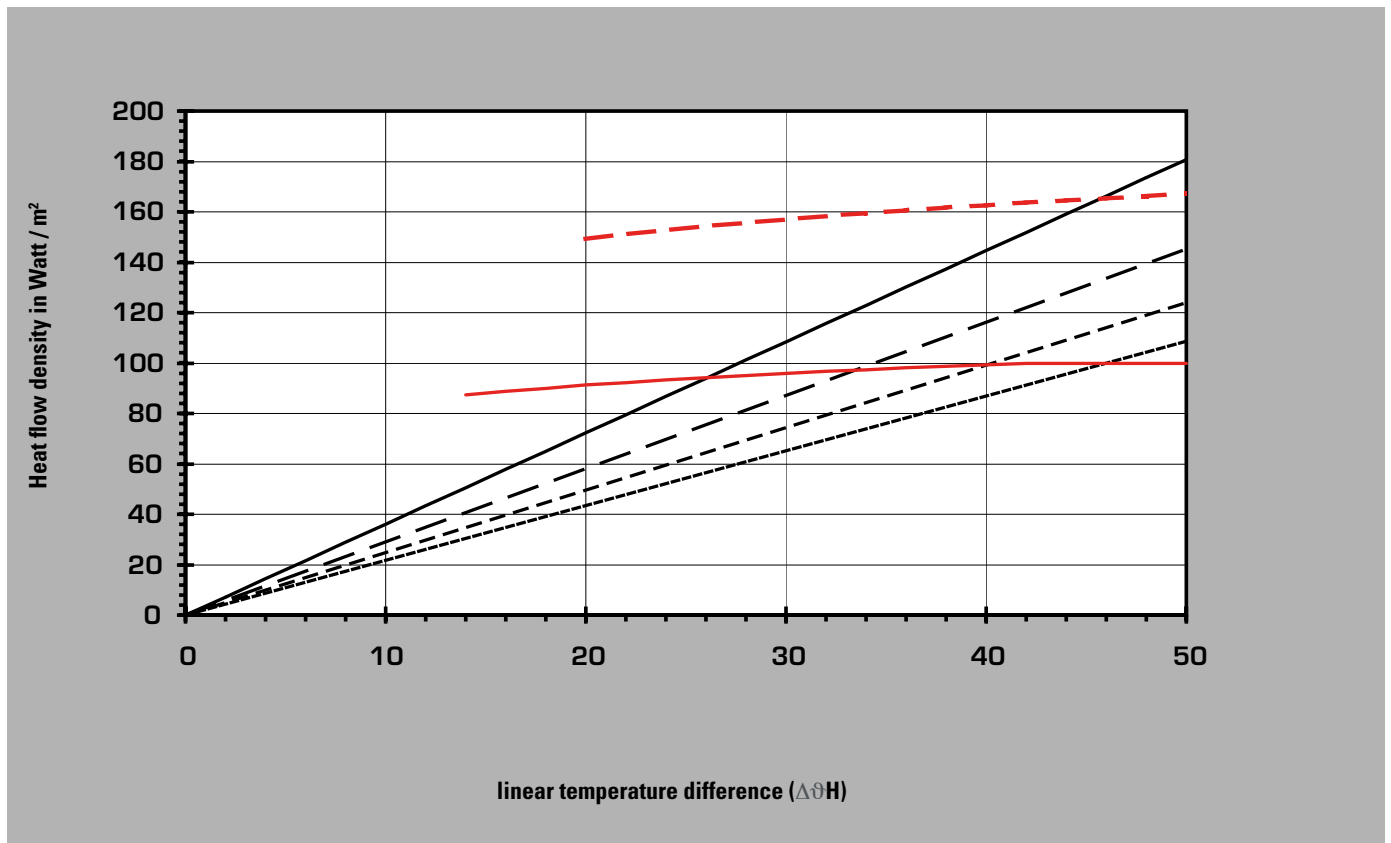

Thermal resistance of surface covering

- 0,00 m<sup>2</sup>K/W
- - - - - 0,05 m<sup>2</sup>K/W
- ..... 0,10 m<sup>2</sup>K/W
- · - · - 0,15 m<sup>2</sup>K/W
- limiting curve dT: 9K
- - - - - limiting curve dT: 15K



## FINE CONTROL VALVES

### Presetting of the fine control valves

#### Pressure difference

The various heating circuits show different pressure losses due to unequal lengths and utilization. The pressure difference to the heating circuit with the highest pressure loss has to be throttled with the fine control valve.

### Example:

Pressure loss of the most unfavourable heating circuit:

$$\Delta p_u = 225 \text{ mbar}$$

Pressure loss of the heating circuit to be controlled:

$$\Delta p_{HK} = 50 \text{ mbar}$$

Pressure difference to be throttled:

$$\Delta p = 175 \text{ mbar}$$

Circulating quantity of water:

$$\dot{m}_G = 75 \text{ kg/h}$$

### Pressure loss / mass flow

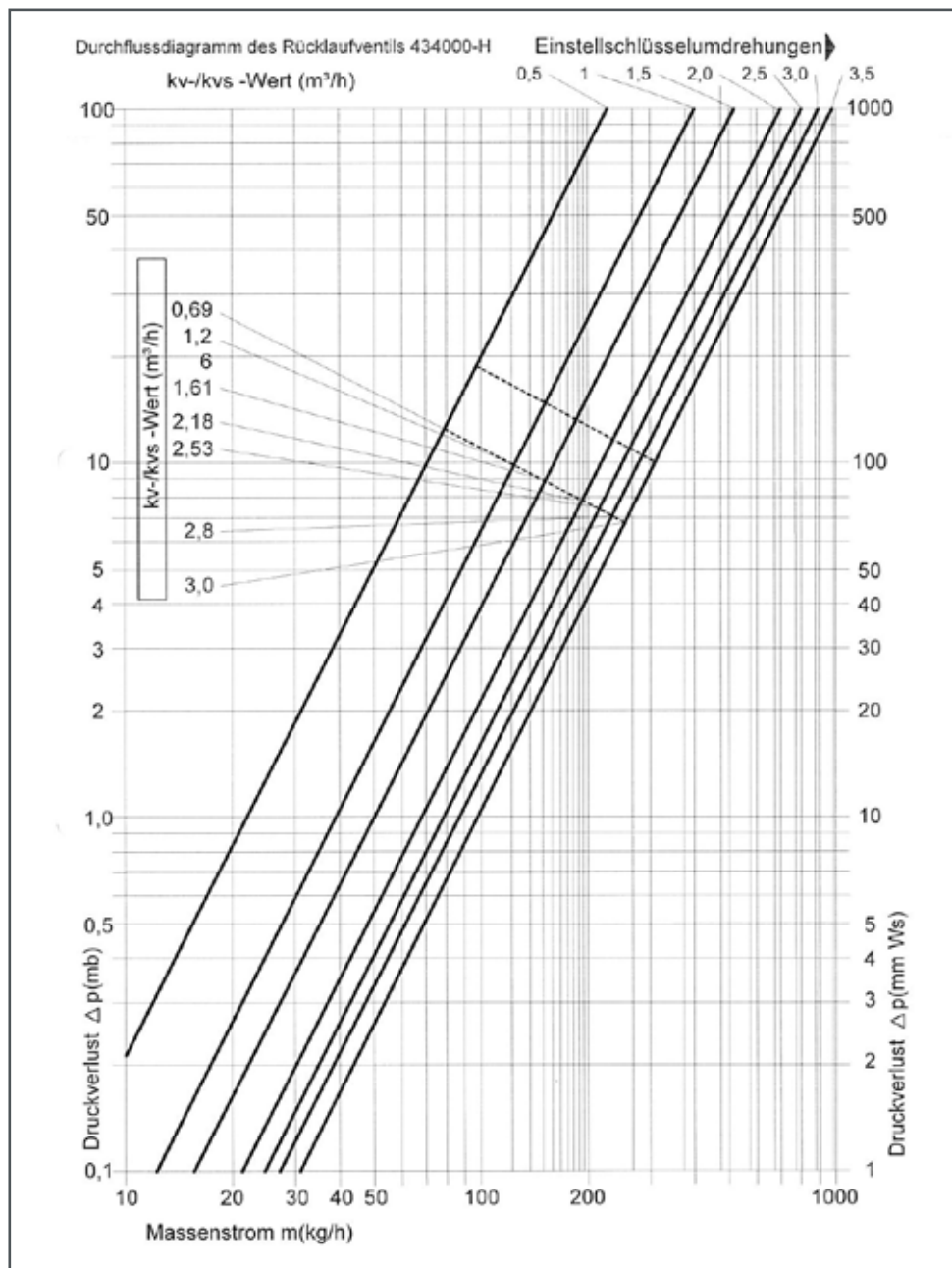

## MEMBRANE EXPANSION VESSEL

Special care should be taken on designing the membrane expansion vessel for underfloor heating systems. It has to be assumed that even with a "tight" installation leakages exist on a small scale enabling the heating water to evaporate unnoticed.

A pressure expansion vessel which has been correctly designed and integrated into the heating installation fulfils the following functions:

- › taking-up of the expansion volume during the heating phase
- › storage of a water supply being fed into the system when required e.g. upon cooling or loss due to leakages
- › maintaining of a minimum excess pressure in the system (pressure keeping)

The following terms are necessary for a correct dimensioning:

- $n$  = expansion coefficient for water in % (s. table)
- $h$  = static height
- $p_{SV}$  = response pressure of the safety valve
- $\Delta p_A$  = response pressure of the safety valve
- $D_f$  = pressure factor
- $V_H$  = nominal size
- $V_e$  = expansion volume
- $V_A$  = water capacity of the system
- $V_N$  = nominal volume of the expansion vessel
- $V_V$  = water capacity of the system
- $p_a$  = nominal volume of the expansion vessel
- $p_e$  = final pressure in bar absolute
- $\vartheta_V$  = max. flow temperature

### Expansion coefficients for water with and without the addition of antifreezing compounds

Temperature °C	without add.	10 % addition	20 % addition	30 % addition	40 % addition	50 % addition
10	0,04	0,32	0,64	0,96	1,28	1,60
20	0,18	0,50	0,82	1,14	1,46	1,78
30	0,44	0,76	1,08	1,40	1,72	2,04
40	0,79	1,11	1,43	1,75	2,07	2,39
50	1,21	1,53	1,85	2,17	2,49	2,81
60	1,71	2,03	2,35	2,67	2,99	3,31
70	2,28	2,60	2,92	3,24	3,56	3,88
80	2,90	3,57	3,54	3,86	4,18	4,50
85	3,21	3,57	3,89	4,21	4,53	4,85
90	3,59	3,91	4,23	4,55	4,87	5,19
95	3,96	4,29	4,61	4,93	5,25	5,57
100	4,35	4,67	4,99	5,31	5,63	5,95
105	4,74	5,07	5,33	5,71	6,01	6,35
107	4,91	5,23	5,55	5,87	6,19	6,51
110	5,15	5,47	5,79	6,11	6,43	6,75
120	6,03	6,35	6,67	6,99	7,31	7,63
130	6,97	7,29	7,61	7,93	8,25	8,57

## TYPES OF PLACING

### Types of placing: spiral type placing

Example of placing A:  
> spiral type placing

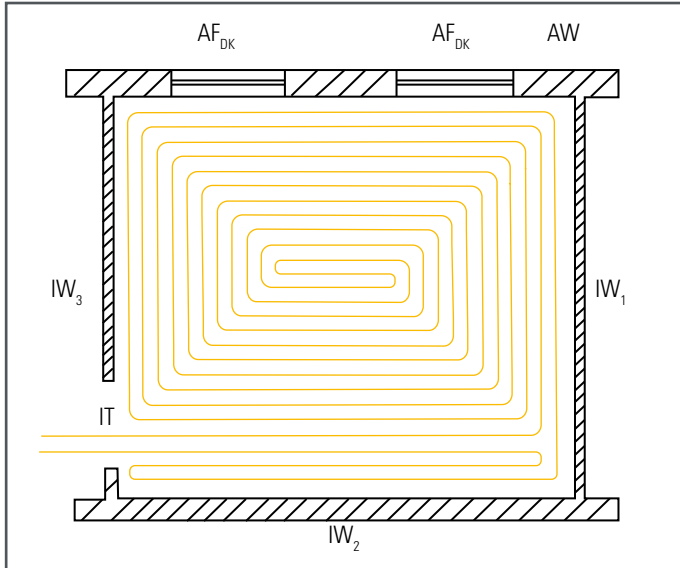

Example of placing B:  
> spiral type placing with separate edge area

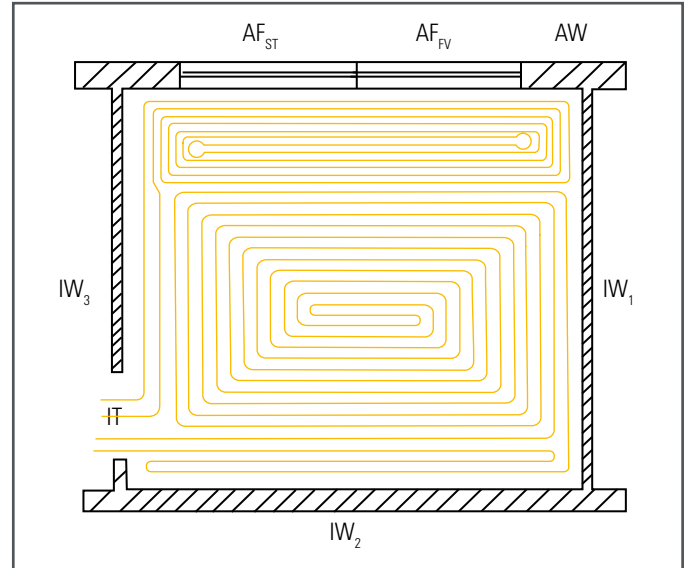

### Types of placing: counterflow-type

Example of placing C:  
> counterflow-type

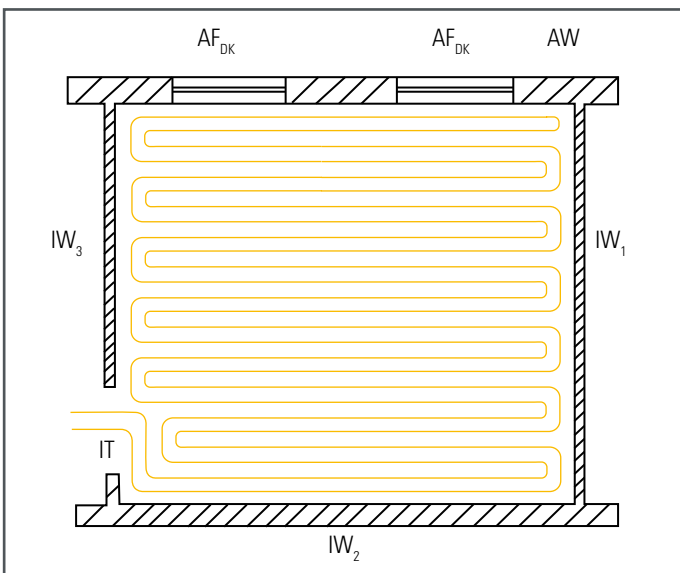

Example of placing D:  
> counterflow-type placing with separate edge area

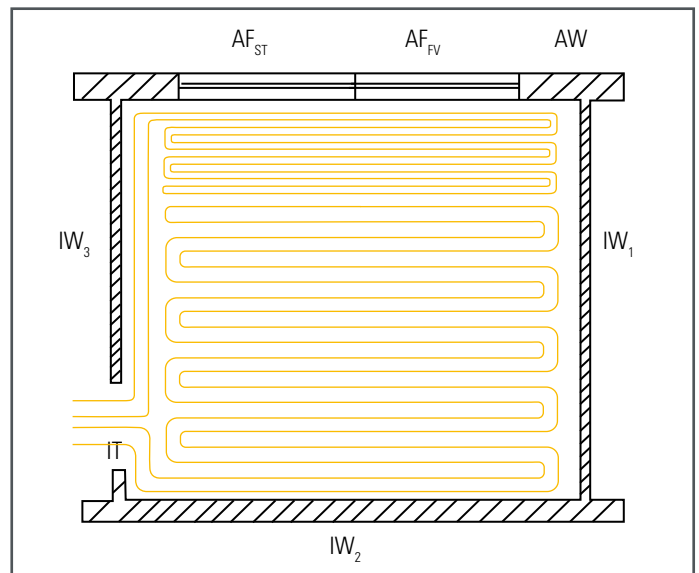

### Legend:

AFDK = outside window pivot / tilt design  
 AW = outside wall  
 IW1 - 3 = inside walls  
 IT = inside door

**EXAMPLE OF PLACING: PIPE SPACING**

**Ground floor**

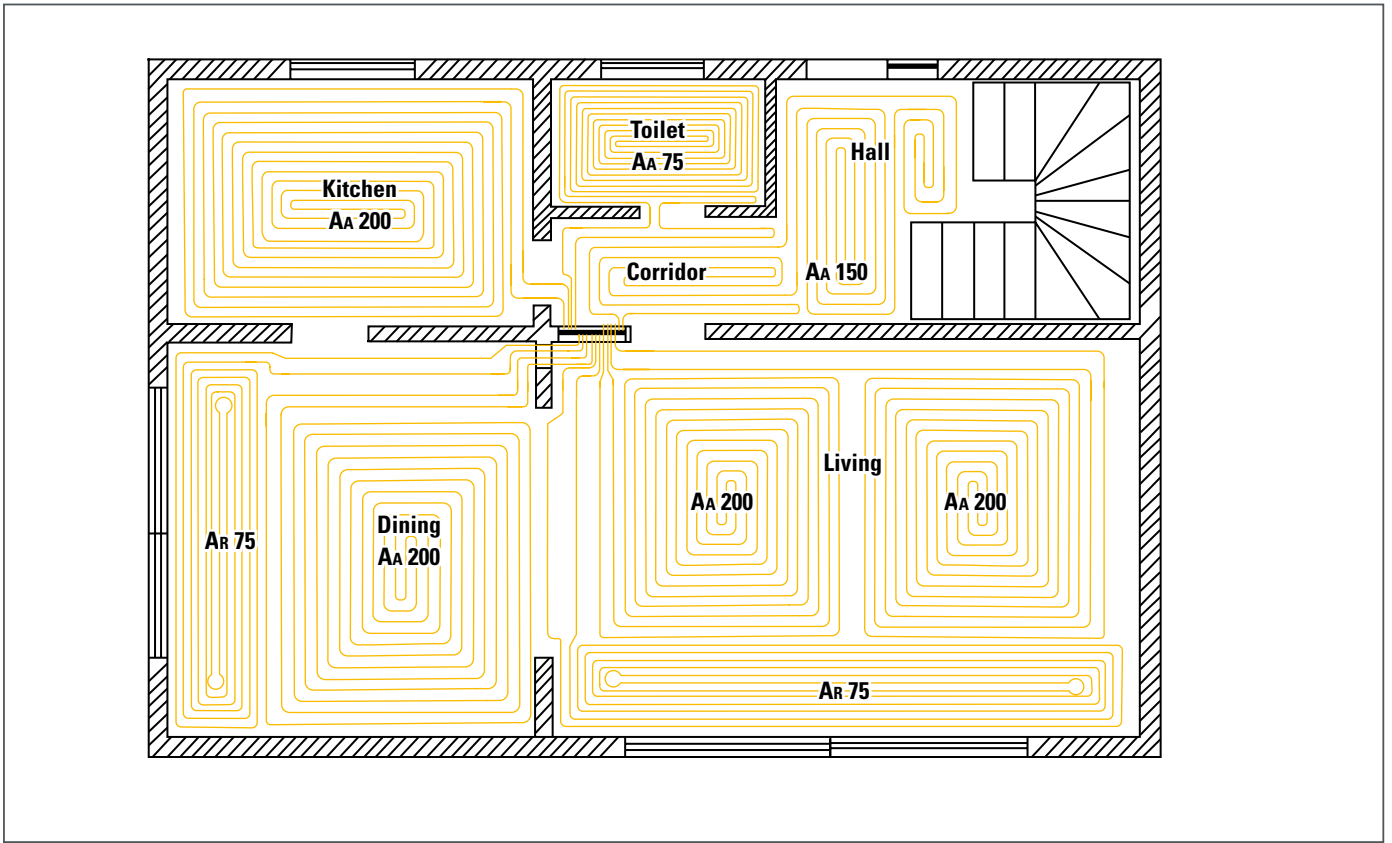

**Upper floor**

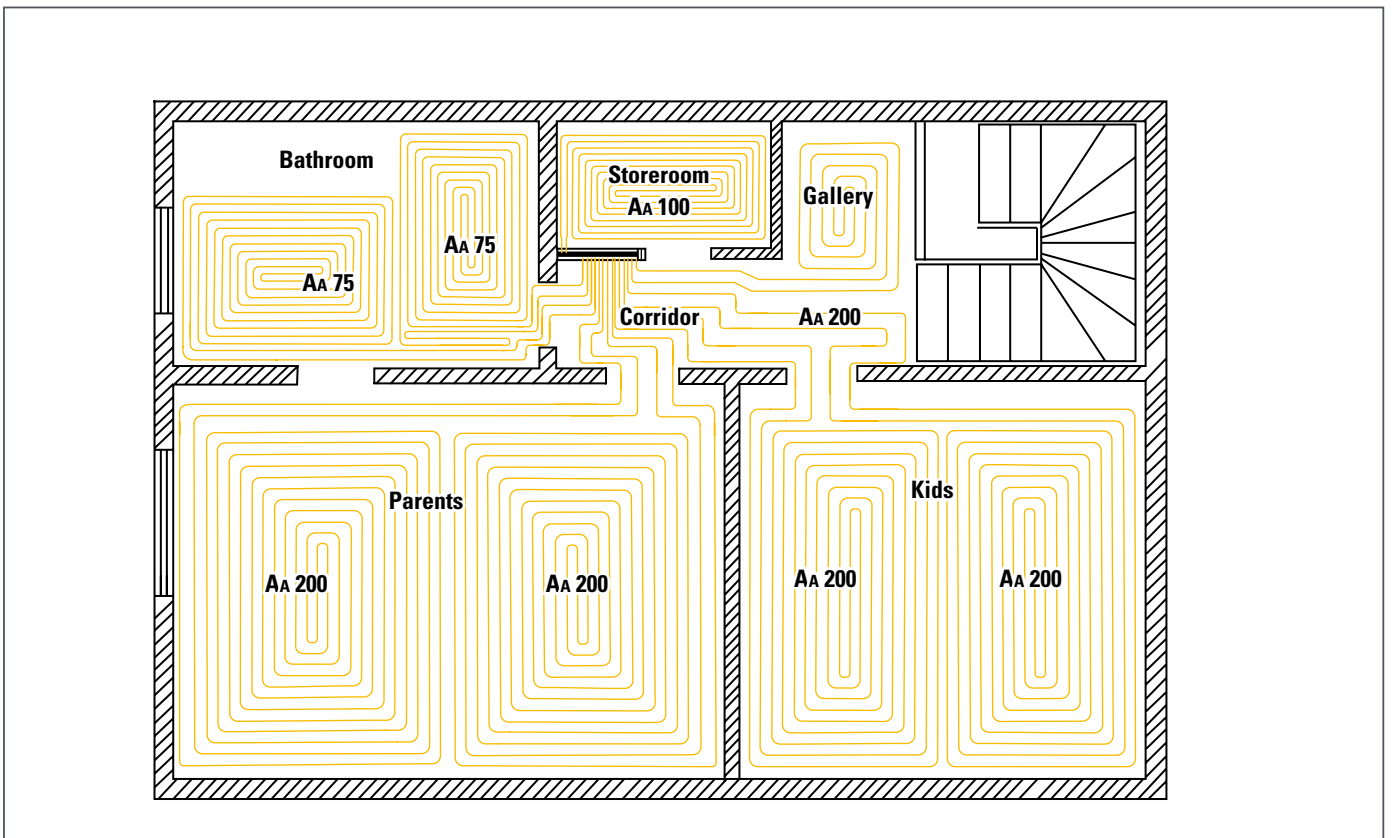

## LAYING OF SYSTEM ELEMENT TS 25

The rough concrete has to be stable and sustainable according to DIN 18560.

The tolerances must correspond to the DIN 18202.

For floors in contact with ground a sealing according to DIN 18195 is required. The aquatherm orange system edge insulation is laid first. It must be arranged continuously at all rising construction components. The edge insulation is cut after the completion of the surface covering. Additional insulation acc. to ENEV or impact sound insulation have to be installed after arranging of the edge insulation.

The system element TS 25 is placed in such a way that the wall ending is always made with a complete board.

Place remaining pieces in the middle of the room wherever applicable!

The heat conducting steel sheets must be pressed into the pipe channels of system element TS 25 after placing. The turning area is omitted. The heat conductivity steel sheets are pre-perforated and thus are easy and simple to arrange.

The heating pipes must be pressed carefully into the heat conductivity steel sheets.

The piping is always made according to the counter-flow principle. Additionally required pipe channels can be cut with a knife, saw or filament cutter. Using wet screed the system element TS 25 is covered finally with PE-foil. The heating circuit manifold should be placed centrally that there is no unnecessary cutting of pipe channels.

DIN 18560 must be observed when constructing with wet screed.

Dry screeds must have a minimum thickness of 25 mm.

For both types of screed the heat-up times acc. to EN 1264 must be obtained.

Example of installation with system element TS 25



## LAYING OF SYSTEM ELEMENT TS 25

### Examples of laying with dry elements



On uneven ground the height leveling is made by filling.



Laying of edge insulation



Laying of system element



Installation of heat conducting steel sheets

## PLANNING AND DESIGN



Laying of heating pipes

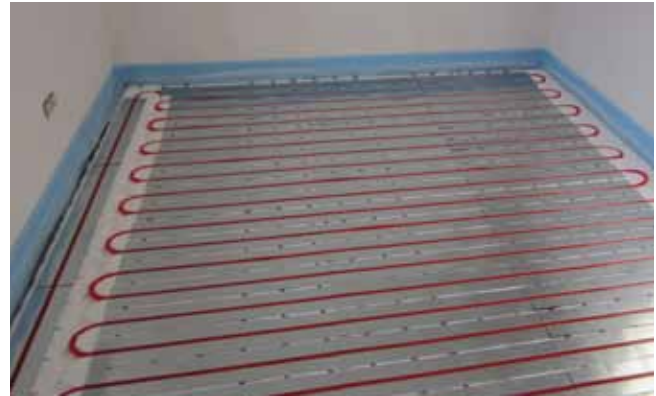

Completed heating system TS



Required extra pipe channels such as connecting pipes are made by filament cutter.



Before installation of the dry elements a release film made of PE is laid.



Completed heating system TS



Finished dry elements



Completed heating system TS



With floor covering

## LAYING OF SYSTEM ELEMENT TS 25

The compact construction provides heights are due to the small board thickness (e.g. 50 mm with dry screed, 55 mm with thin-layer screed, 60 mm with floating screed).

The aquatherm orange system system element TS 25 is the perfect solution for all situations of laying. Interruptions of the construction progress are avoided.

The small constructions provide best conditions for quick control. Due to the low static weight, e.g. by using dry screed, floating screed or a thin cement layer, the system is especially suitable for wooden beam ceilings. The installation can be made on existing floor coverings if they are flat and sustainable. The EPS-material is suitable for working loads up to 60 kN/m<sup>2</sup>, provided that the possibly required additional insulation and the carrying subsoil are adapted to this.

Example of installation with system element TS 25

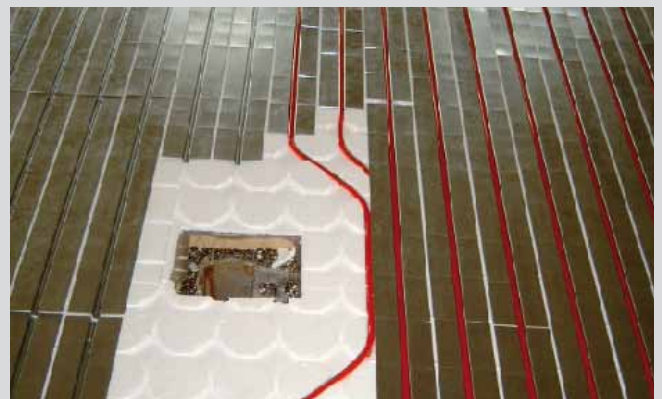

### GRAPH OF HEAT OUTPUT SYSTEM ELEMENT TS 25

Performance system element TS 25 with CAF 35 mm, pipe spacing (PS) = 125 mm

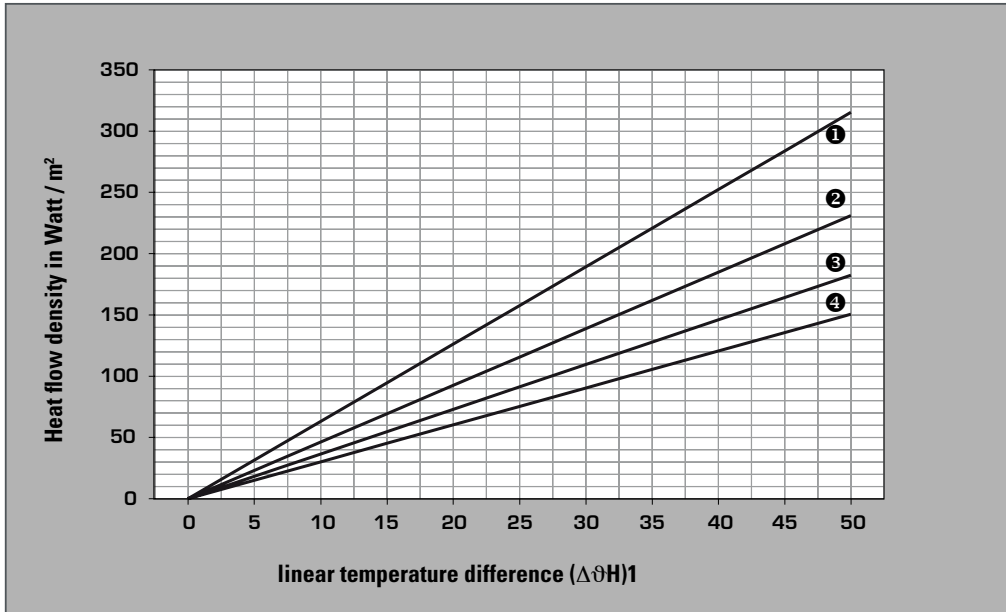

Heat flow q W/m² for PS 125 dry screed 25 mm

- ① without floor covering:  $R\lambda B=0 \text{ m}^2 \text{ K/W}$
- ② PVC, linoleum:  $R\lambda B=0,05 \text{ m}^2 \text{ K/W}$
- ③ carpet:  $R\lambda B=0,10 \text{ m}^2 \text{ K/W}$
- ④ carpet:  $R\lambda B=0,15 \text{ m}^2 \text{ K/W}$

Performance system element TS 25 with CAF 35 mm, pipe spacing (PS) = 250 mm

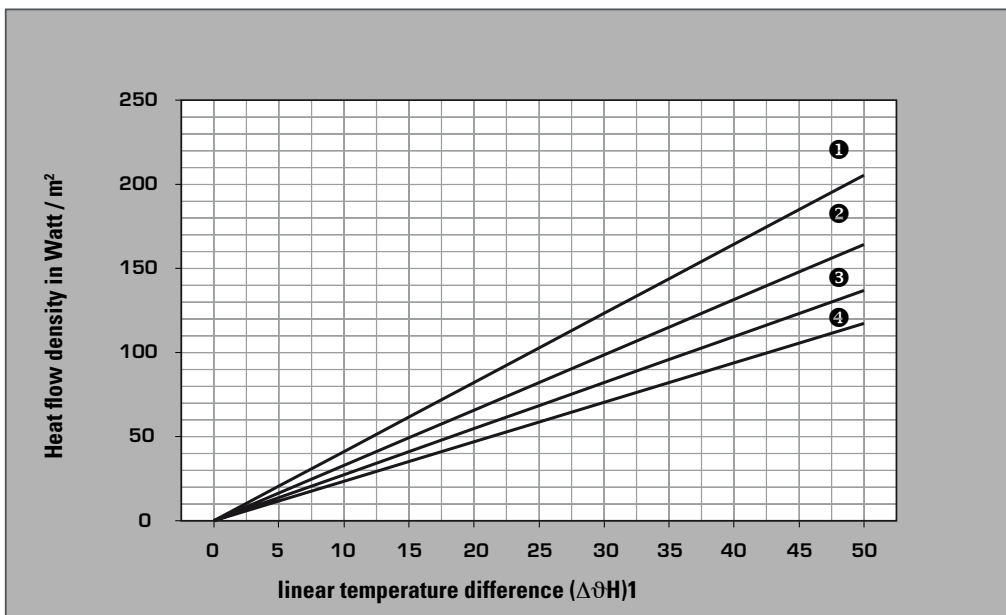

Heat flow density q W/m² for PS 125

- ① without floor covering:  $R\lambda B=0 \text{ m}^2 \text{ K/W}$
- ② PVC, linoleum:  $R\lambda B=0,05 \text{ m}^2 \text{ K/W}$
- ③ carpet:  $R\lambda B=0,10 \text{ m}^2 \text{ K/W}$
- ④ carpet:  $R\lambda B=0,15 \text{ m}^2 \text{ K/W}$

## GRAPH OF HEAT OUTPUT SYSTEM ELEMENT TS 25

Performance system element TS 25 with CAF 45 mm, pipe spacing (PS) = 125 mm

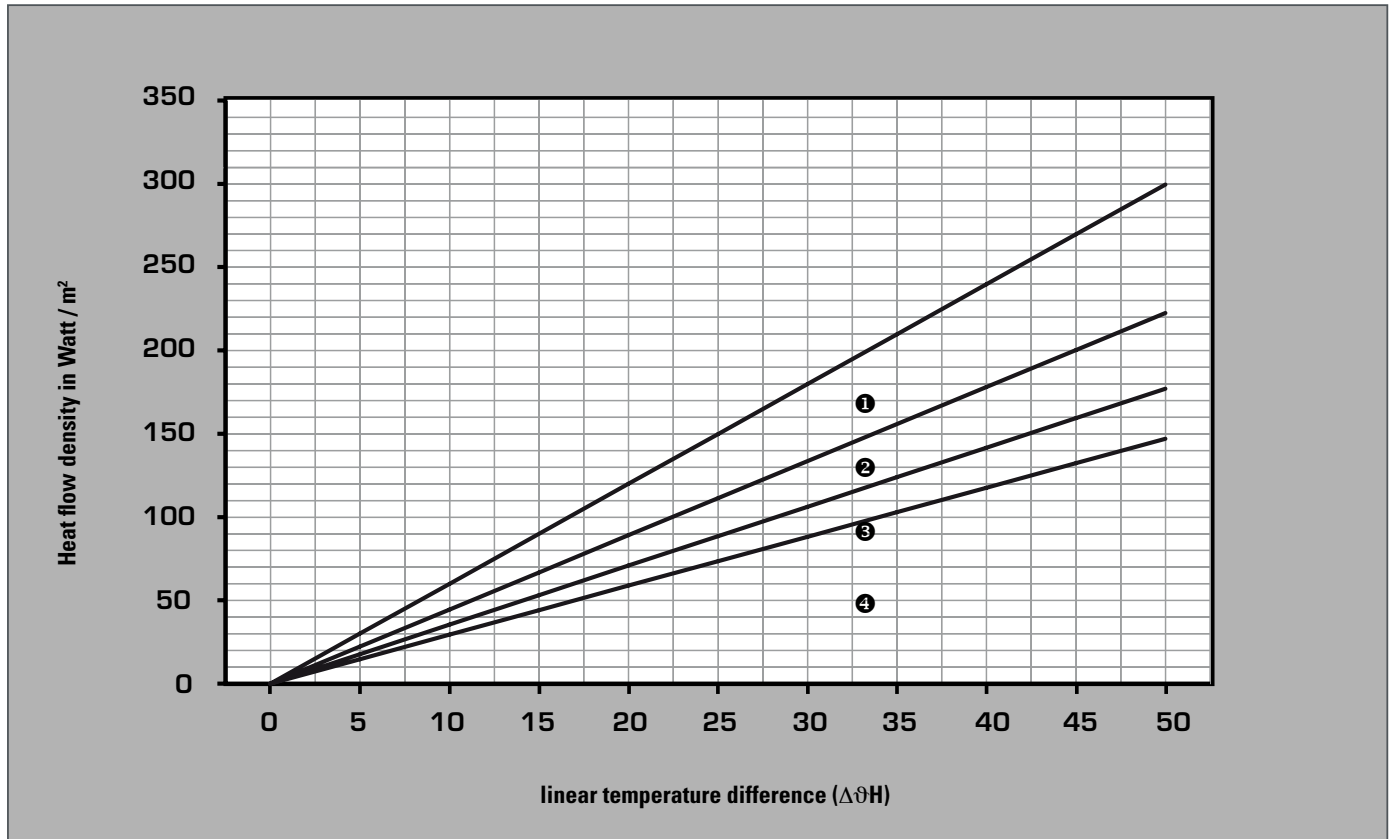

### Heat flow density $q$ W/m<sup>2</sup> for PS 125

- ❶ without floor covering:  $R\lambda \cdot B = 0 \text{ m}^2 \text{ K/W}$
- ❷ PVC, linoleum:  $R\lambda \cdot B = 0,05 \text{ m}^2 \text{ K/W}$
- ❸ carpet:  $R\lambda \cdot B = 0,10 \text{ m}^2 \text{ K/W}$
- ❹ carpet:  $R\lambda \cdot B = 0,15 \text{ m}^2 \text{ K/W}$

## GRAPH OF HEAT OUTPUT SYSTEM ELEMENT TS 25

Performance system element TS 25 with CAF 45 mm, pipe spacing (PS) = 250 mm

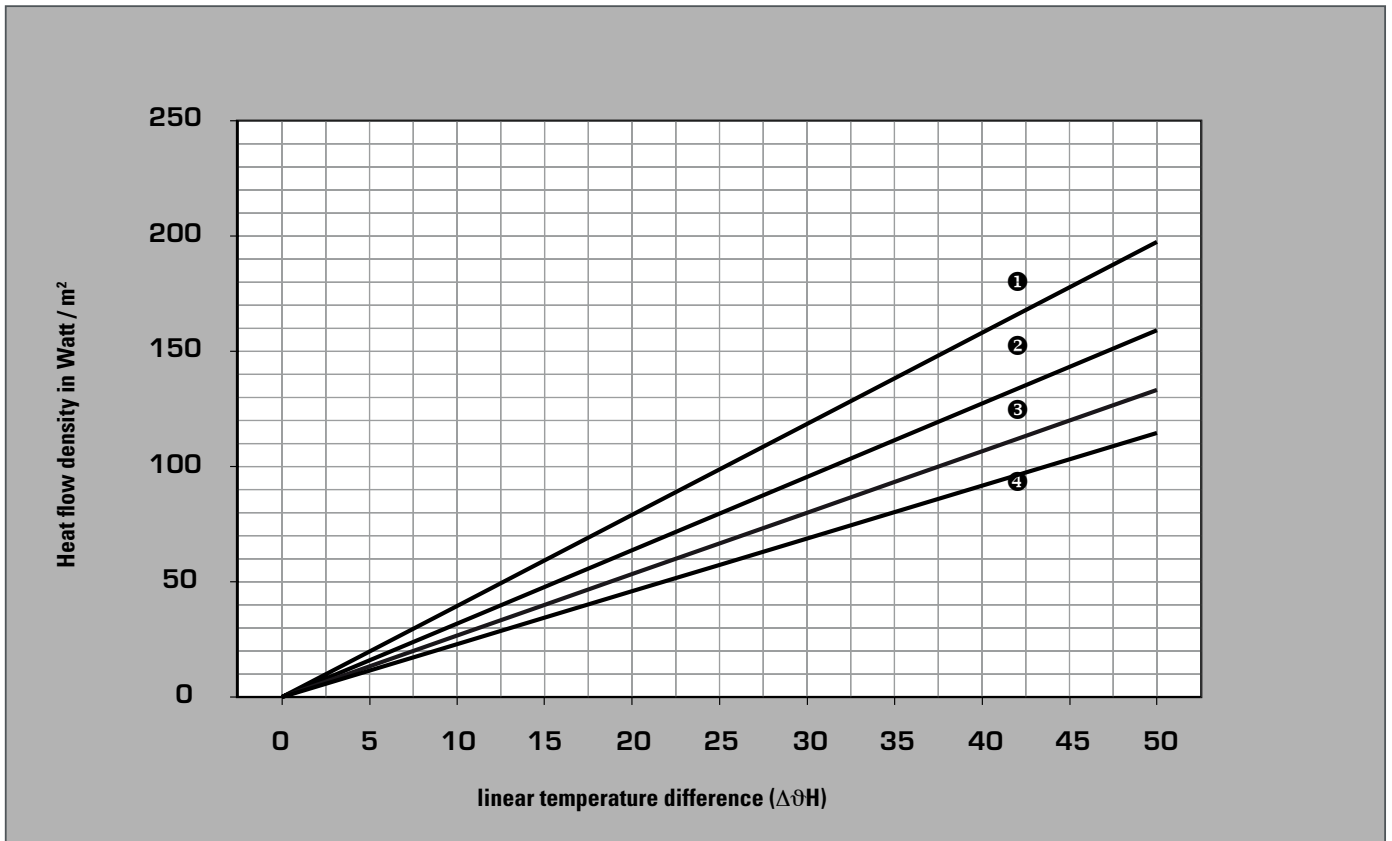

### Heat flow density $q \text{ W/m}^2$ for PS 250

- ① without floor covering:  $R\lambda \cdot B = 0 \text{ m}^2 \text{ K/W}$
- ② PVC, linoleum:  $R\lambda \cdot B = 0,05 \text{ m}^2 \text{ K/W}$
- ③ carpet:  $R\lambda \cdot B = 0,10 \text{ m}^2 \text{ K/W}$
- ④ carpet:  $R\lambda \cdot B = 0,15 \text{ m}^2 \text{ K/W}$

### GRAPH OF HEAT OUTPUT SYSTEM ELEMENT TS 25

Performance system element TS 25 with dry screed ( $\lambda = 0,35 \text{ W/mk}$ ) pipe spacing (PS) = 125 mm

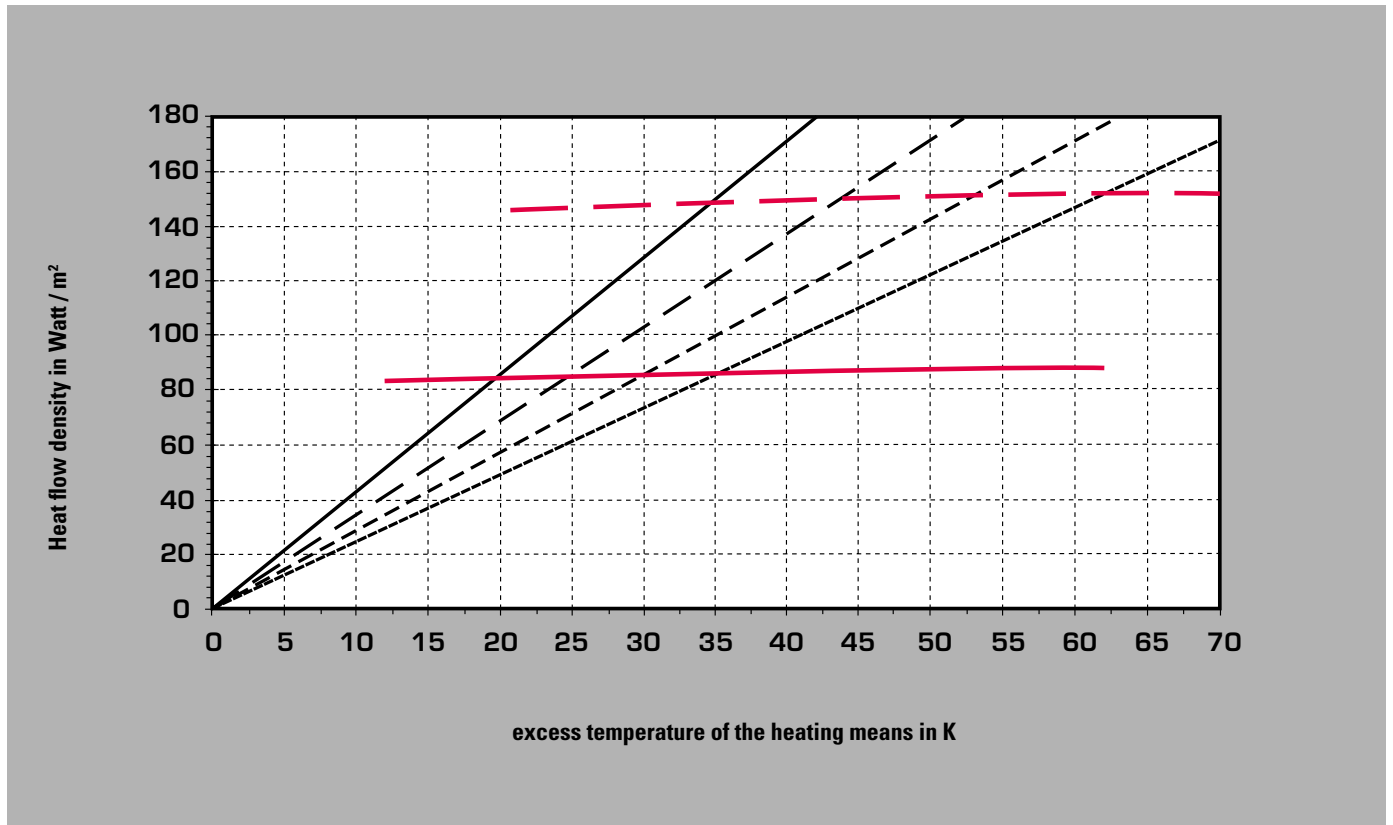

Thermal resistance of surface covering

- $0,00 \text{ m}^2\text{K/W}$
- - -  $0,05 \text{ m}^2\text{K/W}$
- · ·  $0,10 \text{ m}^2\text{K/W}$
- · - ·  $0,15 \text{ m}^2\text{K/W}$
- (red) limiting curve  $dT:9\text{K}$
- - - (red) limiting curve  $dT:15\text{K}$

**GRAPH OF HEAT OUTPUT SYSTEM ELEMENT TS 25**

Performance system element TS 25 with dry screed ( $\lambda = 0,35 \text{ W/mk}$ ) pipe spacing (PS) = 250 mm

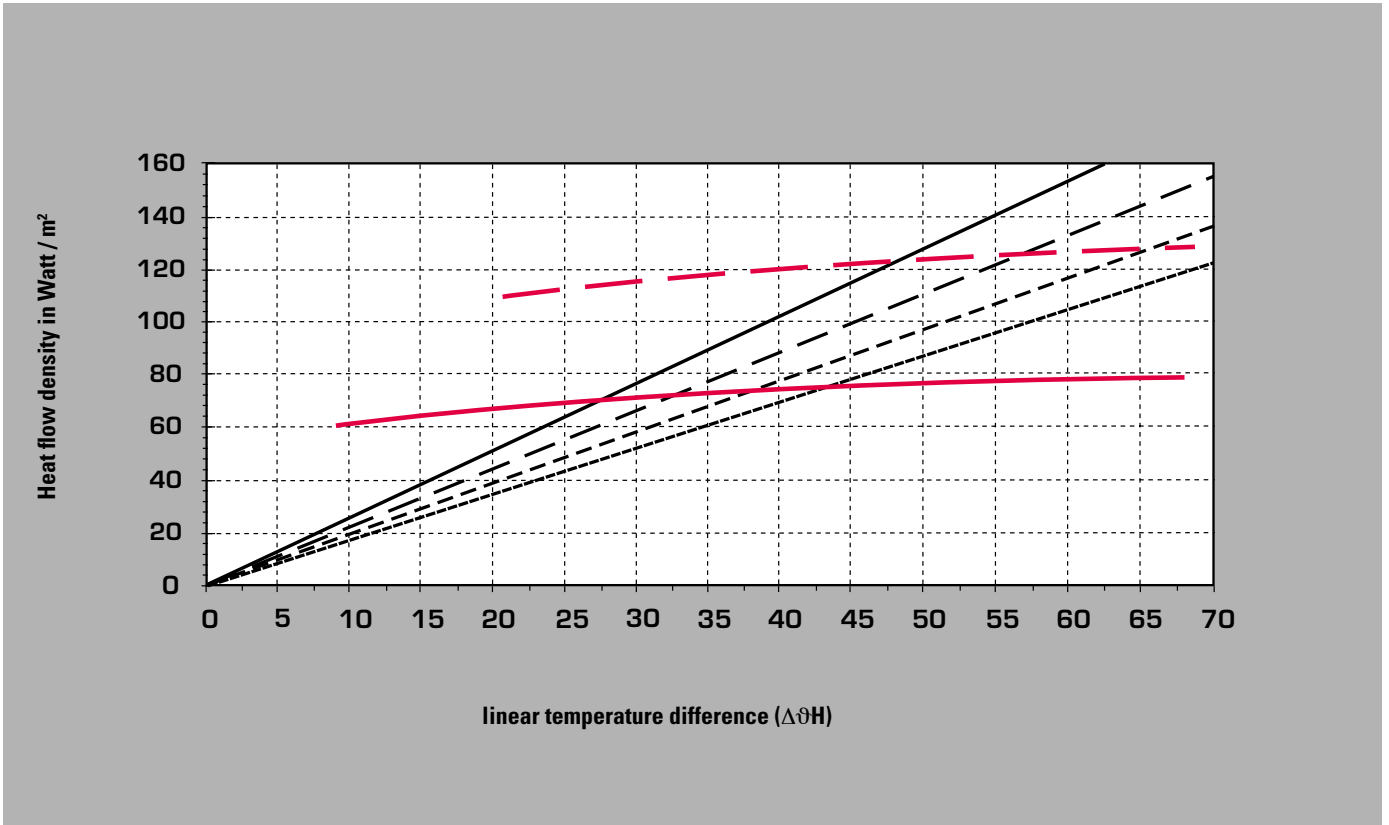

Thermal resistance of surface covering

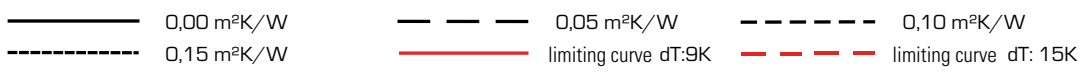



## ПРОДУКЦИЯ ГРУППА КОМПАНИЙ АГПАЙП

AQUATHERM GmbH - немецкие инженерные системы для различных областей применения. Имеют полное соответствие законодательству и сертификации на территории Российской Федерации. Включают в себя линейки для питьевого водоснабжения, пожаротушения, отопления, транспортировки химии и сжатого воздуха. Гарантийные обязательства завода 10 лет и 20 миллионов Евро.



### aquatherm green pipe

Трубопроводная система aquathermm green pipe из инновационного материала Fusiolen для систем питьевого водоснабжения и отопления.

Ассортимент системы состоит из различных видов труб, диаметром от 16 мм до 450 мм в виде «штанг» или в бухтах.

### aquatherm blue pipe

Трубопроводная система aquathermm blue pipe из инновационного материала Fusiolen специально разработанная для систем холодоснабжения, обогрева поверхностей, транспортировки агрессивных сред и сжатого воздуха.

Ассортимент системы состоит из различных видов труб, диаметром от 16 мм до 630 мм в виде «штанг» или в бухтах.

### aquatherm red pipe

Трубопроводная система aquathermm red pipe из материала Fusiolen FS для пожаротушения, сертифицированная институтом ВНИИПО МЧС РФ для применения в системах АУПТ и противопожарном водопроводе.

Трубы поставляются диаметром от 20 до 160 мм в виде «штанг».

REDI PHONOLINE - итальянские трубопроводные системы из материала НПВХ для внутренней ливневой и фекальной канализации, с высокими техническими показателями шумопоглощения, рабочего давления. Полностью сертифицированы на территории РФ, включая сертификат группы горючести Г1.



Итальянская канализационная система для внутренней ливневой и фекальной канализации из материала НПВХ. Система поставляется диаметрами от 40 до 630 мм.



Итальянские обратные клапана для канализации Redi Ottima разработаны по европейским стандартам EN13564, с высокими техническими характеристиками.

### QuickStream PE

Quickstream - напорная сифонно-вакуумная система для удаления воды с крыш, максимально эффективна на кровлях большой площади. Широкий ассортимент элементов - от воронок до точек выхода. Принцип работы обеспечивает существенное увеличение производительности при уменьшении диаметров труб, по сравнению с традиционной канализацией.

### MUPRO

Крепежные и виброизоляционные системы немецкого производства Mupro. Основные решения компании направлены на крепление трубопроводных систем отопления, водоснабжения, вентиляции и кондиционирования. Ассортимент продукции насчитывает более 100 тысяч наименований.

- Хомуты для крепления труб
- Неподвижные/подвижные опоры
- Крепление тяжелых труб
- Профиль монтажный
- Инструменты
- Нержавеющая сталь
- Система StaboFix
- Вентеляционный крепеж

## ОБЛАСТИ ПРИМЕНЕНИЯ



Питьевое водоснабжение



Техническое водоснабжение



Трубы для пожаротушения



Трубы для бассейнов



Трубы для отопления



Канализация



Трубы для химии



Предизолированные трубы



Трубы для холодоснабжения



Климатизация



Кораблестроение



Трубы для пневмомагистралей



Management  
System  
ISO 9001:2008  
ISO 14001:2004  
ISO 50001:2011  
[www.tuv.com](http://www.tuv.com)  
ID 0091005348

## aquatherm GmbH

Biggen 5 | D-57439 Attendorn | Phone: +49 (0) 2722 950-0 | Fax: +49 (0) 2722 950-100

Wilhelm-Rönsch-Str. 4 | D-01454 Radeberg | Phone: +49 (0) 3528 4362-0 | Fax: +49 (0) 3528 4362-30

[info@aquatherm.de](mailto:info@aquatherm.de) [www.aquatherm.de](http://www.aquatherm.de)

Order-No.: E90001  
Edition: 09.2013