



aquatherm green pipe

Pipe system

For potable water supply



aquatherm

state of the pipe



NEW SINCE THE LAST VERSION

Page	Change
------	--------

–	The Naming faser changed into fibre
---	-------------------------------------

–	Article Number Overhaul.
---	--------------------------

84-86	Pages got removed.
-------	--------------------

NOTE:

aquatherm green pipe and aquatherm blue pipe are divided into separate catalogues. The order number for the aquatherm blue pipe catalogue is E10050.

TABLE OF CONTENTS

Service	4	Thermal insulation of hot water pipes	75
Product overview	6	Insulation thickness	76
Short cuts & symbols	8	Pressure test	77
		Pressure test – test record	79
		Flushing of pipes/earth wire/transport and storage	81
		Water point connections	82
		Distribution block	83
Systems & features		Chemical resistance	84
aquatherm polypropylene pipe systems	10	Warranty	86
aquatherm green pipe	11	Planning	89
Composite technology	14	DIN 1988 T3/Maximum flow rate/Principles of calculation	90
aquatherm green pipe li	15	CAD and BIM data	
Potable water installation & heating systems	16	Minimum flow pressure	91
Comparison of the water content per meter	18	Coefficient of loss aquatherm green pipe fittings	94
Ring stiffness	19	Planning & design of compressed air applications	96
Permissible working pressure	20	Coefficient of loss aquatherm green pipe distribution block	97
UV-resistance	22		
Chemical and thermal disinfection	22		
Integration of other systems or components	23		
Domestic hot water recirculation			
Fire protection	24		
Material: fusiolen®	28		
aquatherm & ecology	29		
Hygienic suitability/Sound Insulation	29		
Environmental Product Declaration and LEED certification	30		
Quality assurance			
Compliance with the system standard/Quality management	31		
System control/Internal control	32		
External control	34		
Fusion: Welding technology			
Part A: Tools and accessoires	38		
Part A: Assembly of welding tools	39		
Part A: Heating up phase/handling	40		
Guidelines			
Part B: Checking of devices and tools	41		
Preparation for the fusion			
Part B: Heating of pipe and fitting	42		
Setting and alignment			
Part B: Universal peeling tools	43		
Part C: Weld-in saddles	45		
Part C: Weld-on saddle	48		
Part D: Welding jig (hitch)	49		
Part E: Welding machines	52		
Part E: Electrofusion device	54		
Repair options	57		
Part G: Butt-welding	58		
Visual inspection of fusion seam	60		
Flange connections	62		
Installation principles			
Fastening technique/Fixed points/Sliding points	63		
Installation advice/Linear expansion/Concealed installation	63		
Installation in ducts	64		
Open installation/Calculation of the linear expansion	65		
Linear expansion	66		
Pipe clamps	68		
Bending side	69		
Expansion loop/Pre-stress/Bellow expansion joint	70		
Length of bending side	71		
Length of bending side with pre-stress	72		
Support intervals	73		

SERVICE

TECHNICAL HOTLINE +49 2722 950 200

info@aquatherm.de www.aquatherm.de

Headquarters Attendorn

aquatherm GmbH
Biggen 5
57439 Attendorn
Germany
Phone: +49 2722 950 0

Subsidiary Radeberg

aquatherm GmbH
Wilhelm-Rönsch-Str. 4
01454 Radeberg
Germany
Phone: +49 3528 4362 0



Technical sales

Whether briefing on site, system briefing in your workshop or counter events and tool days at the specialized trade: In addition to the regular training in Attendorn, the aquatherm application engineers are every day and everywhere in Germany on the way.

A list of our partners worldwide can be found on our website www.aquatherm.de in the category „contact“.



Training

In addition to the proven lectures and counter events in the specialized trade and the training at the guild associations, aquatherm regularly offers specialist seminars and information events at the training center in Attendorn.

Trade shows

aquatherm is represented with its own booth at all important sanitary and HVAC trade shows in Germany and abroad. Information on trade fair dates in your area are available at www.aquatherm.de in the „service“ area.

Certifications in accordance with ISO 9001, 14001 & 50001

Since 1996 aquatherm fulfills the requirements of the quality management system according to DIN ISO 9001. The 2012 TÜV certificate was extended by the environmental management system according to ISO 14001 and currently by the energy management system according to ISO 50001.

This success is another step towards strengthening our competitive position and to meet the high requirements and the responsibility for our customers, partners and the environment.



Management System
ISO 9001:2015
ISO 14001:2015
ISO 50001:2011
www.tuv.com
ID 0091005348



Laboratory

From testing of granulate properties to permanent process monitoring: Only perfect goods have the chance to leave aquatherm.



Software service

The aquatherm software service provides Datanorm files, BIM-compatible files, an independent graphical configuration program (liNear) as well as the appropriate training on site.



Brochures and more

No matter whether brochures, catalogues or product lists are concerned: Everything is developed by our in-house marketing department. All documents can be downloaded as PDF from our website www.aquatherm.de. For printed copies just send an e-mail to infoservice@aquatherm.de.

SERVICE

PRODUCTS

aquatherm is the leading manufacturer of polypropylene pipe systems for plant engineering and building services. The numerous product lines provide superior solutions in potable water applications, heating systems, fire sprinkler systems, air-conditioning and refrigeration technology, as well as in surface heating and cooling systems. The product range comprises more than 17,000 articles in six product lines.

		Dimension [mm]																		
		16	17	20	25	32	40	50	63	75	90	110	125	160	200	250	315	355	400	
aquatherm green pipe	SDR 6 S	●		●	●	●	●	●	●	●	●	●								
aquatherm green pipe	SDR 7,4 S	●		●	●	●	●	●	●											
aquatherm green pipe	SDR 7,4 MF			●	●	●	●	●	●	●	●	●	●	●	●	●				
aquatherm green pipe	SDR 7,4 MF UV			●	●	●	●	●	●	●	●	●	●	●	●	●				
aquatherm green pipe	SDR 9 MF RP					●	●	●	●	●	●	●	●	●	●	●	●			
aquatherm green pipe	SDR 9 MF RP UV					●	●	●	●	●	●	●	●	●	●	●	●			
aquatherm green pipe	SDR 9 MF RP TI					●	●	●	●	●	●	●	●	●	●	●	●			
aquatherm green pipe	SDR 11 S			●	●	●	●	●	●	●	●	●	●	●	●	●	●			
aquatherm blue pipe	SDR 7,4 MF			●	●															
aquatherm blue pipe	SDR 7,4 MF UV			●	●															
aquatherm blue pipe	SDR 7,4 MF OT			●	●															
aquatherm blue pipe	SDR 9 MF RP					●														
aquatherm blue pipe	SDR 9 MF RP UV					●														
aquatherm blue pipe	SDR 9 MF RP OT					●														
aquatherm blue pipe	SDR 9 MF RP TI					●														
aquatherm blue pipe	SDR 9 MF RP OT TI					●														
aquatherm blue pipe	SDR 11 S			●	●															
aquatherm blue pipe	SDR 11 MF RP						●	●	●	●	●	●	●	●	●	●	●	●	●	●
aquatherm blue pipe	SDR 11 MF RP UV						●	●	●	●	●	●	●	●	●	●	●	●	●	●
aquatherm blue pipe	SDR 11 MF RP OT						●	●	●	●	●	●	●	●	●	●	●	●	●	●
aquatherm blue pipe	SDR 11 MF RP TI						●	●	●	●	●	●	●	●	●	●	●	●	●	●
aquatherm blue pipe	SDR 11 MF RP OT TI						●	●	●	●	●	●	●	●	●	●	●	●	●	●
aquatherm blue pipe	SDR 17,6 MF RP												●	●	●	●	●	●	●	●
aquatherm blue pipe	SDR 17,6 MF RP UV												●	●	●	●	●	●	●	●
aquatherm blue pipe	SDR 17,6 MF RP TI												●	●	●	●	●	●	●	●
aquatherm red pipe	SDR 7,4 MF HI					●	●	●	●	●	●	●	●							
aquatherm black system	M OT																			
aquatherm orange system	M OT	●	●	●	●															
aquatherm grey pipe	M OT	●		●	●	●														

SHORT CUTS & SYMBOLS

Abbreviations pipe structure

S	single-layer
M	multi-layer
MF	multi-layer, fibre-reinforced
RP	raised pressure resistance
UV	UV-resistant
OT	oxygen-tight
TI	thermally insulated

Abbreviations material

PP	polypropylene
PP-R	polypropylene random copolymer
PP-RCT	polypropylene random copolymer with raised pressure resistance
PE-RT	polyethylene with raised temperature resistance

◆ = Only available on request.

APPLICATION AREAS



Potable water application



Sports floor heating and cooling



Heating system construction



Swimming pool technology



Heating and cooling connection



Chemical transport



Underfloor heating



Rainwater application



Wall heating



Irrigation



Ceiling heating and cooling



Fire protection sprinkler-systems



Industrial floor cooling



Shipbuilding



Industrial floor heating



District heating



Chilled water technology



Geothermal



Agriculture



Dear readers,

We are always making decisions – in every minute of every hour of every day. At this moment, you have decided to open our catalogue to consciously find out more about our company aquatherm.

Without knowing the reason behind your decision, we can promise you one thing, namely that the insight into our colourful, yet always slightly green tinged, aquatherm world is sure to impress you!

As a family business which is passionate about all it does we, together with our employees, confidently meet all challenges and, in doing so, are able to trustfully call upon values which have defined our company for already more than four successful decades.

We know where we want to go without forgetting where we came from. Hereby we like to live with the role of not being a “normal” business. The characteristics “being different” and “special” represent our motivation in all that we do to be the best.

We are “state of the pipe” because we act independently and decisively and are hereby always reliable which makes us the leading manufacturer of polypropylene pipes.

We were, are and will remain as this – promise!

But see for yourself and decide upon aquatherm not only in the next few moments but also in the long term.

Best wishes

Christof Rosenberg
Managing Director

Dirk Rosenberg
Managing Director

Maik Rosenberg
Managing Director

Gerhard Rosenberg
President of the Advisory Board

- 1973 aquatherm founded by Gerhard Rosenberg
- 1981 development of the first pipe system made of polypropylene; the colour green becomes a characteristic feature of aquatherm
- 1991 subsidiary Radeberg was founded
- 1996 first certification of the quality management system in accordance with ISO 9001
- 1997 foundation of the sales company in Italy
- 1999 development of fusiotherm® fibre composite pipe
- 2001 aquatherm operates in more than 50 export markets
- 2002 market launch of the aquatherm blue pipe
- 2005 market launch of the aquatherm red pipe and aquatherm black system
- 2010 system expansion of the pipe size to max. ø630 mm
- 2010 Christof, Dirk and Maik Rosenberg assume company management
- 2012 first certification of the environment management system in accordance with ISO 14001
- 2012 market launch of the material fusiolen® PP-RP
- 2013 first certification of the energy management system in accordance with ISO 50001
- 2015 foundation of the sales company in North America
- 2017 opening of the new pipe extrusion plant
- 2018 opening of the new injection moulding facility
- 2018 foundation of the sales company in England
- 2019 expansion of the industrial prefabrication operation
- 2021 participation in the distribution company aquatherm ibérica s.l.

aquatherm pipe systems

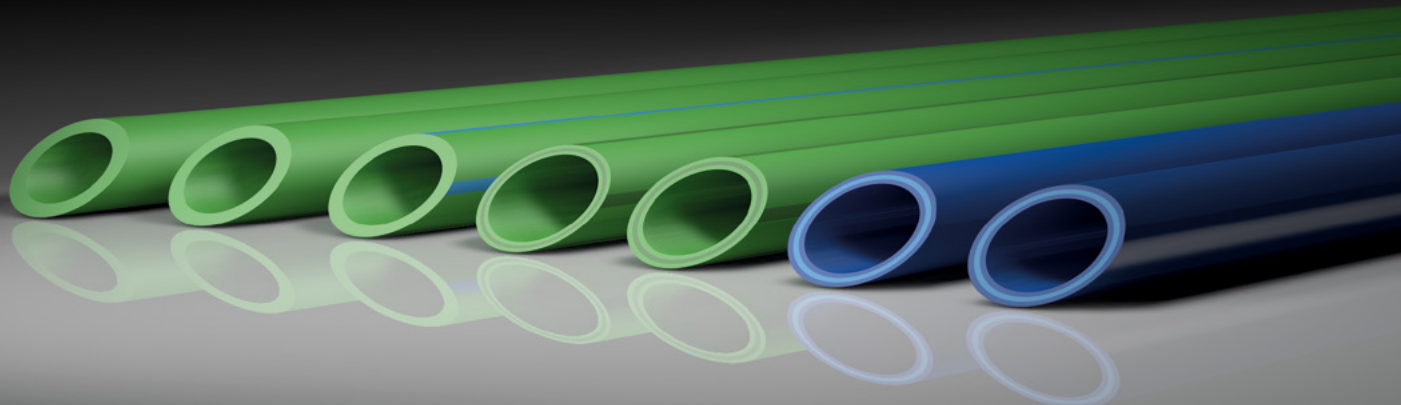

AQUATHERM POLYPROPYLENE PIPE SYSTEMS

The history of the aquatherm pipe systems began in 1973 when Gerhard Rosenberg founded a company for warm water underfloor heating systems. Initially, the owner's garage and basement served as the company's headquarters and production facility. A lot has happened since then.

In the past more than 40 years, aquatherm has proven to be the world's leading manufacturer of plastic pipe systems made of polypropylene for plant engineering and building services. The numerous product lines provide superior solutions in potable water applications, heating systems, fire sprinkler systems, air conditioning and refrigeration technology, as well as in surface heating and cooling systems. The product range comprises almost 17,000 articles in six product lines.

Due to their special material properties, the aquatherm pipe systems convince by their diverse application possibilities.

The aquatherm pipe systems can be used in all areas of new installation, repair and renovation.

AQUATHERM PIPE SYSTEMS

Characteristics

aquatherm polypropylene pipe systems stop corrosion damages. All materials are corrosion-resistant and have reduced flow noise compared to metallic pipes. aquatherm pipes are opaque. There is therefore no risk of algae formation.

Installation

aquatherm pipes and fittings are connected by heat fusion, which creates a homogeneous, cohesive unit with no leak paths. Heat fusion connections are stronger than the pipe itself, providing lasting safety at these critical points of a piping system. A properly executed aquatherm fusion creates a permanent leakproof connection.

An aquatherm pipe with an outside diameter of 20 mm can be heat fused in only 5 seconds.

aquatherm pipe connections can be hydraulic pressure tested or put into operation directly after their fusion. There are no waiting times.

Quality

Quality is very important to aquatherm. This is not only reflected in the national and international certification marks, but also in the high satisfaction level of aquatherm customers, installers and engineers. For more details regarding quality and certificates see page 31.

Warranty

Due to the high product quality, aquatherm offers a 10-years warranty on all pipes and fittings instead of the 2 years applicable under German law. The extended warranty period is covered by a comprehensive insurance policy from a leading insurance company in our industry. For details, see the Warranty section of this catalogue.

Price advantage

aquatherm offers you high quality, durable piping systems at an optimal price / performance ratio.

aquatherm green pipe

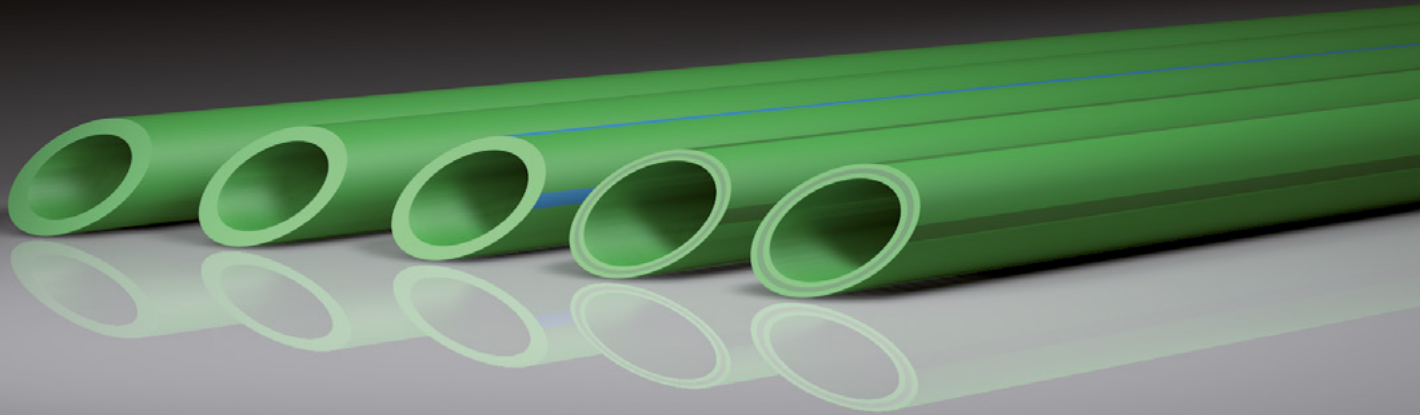

aquatherm green pipe

aquatherm green pipe has revolutionized the plastic piping sector and has proven its technical suitability worldwide for decades. The innovative green pipe from aquatherm is made of corrosion-resistant, chemically inert polypropylene. It is completely free of heavy metals and toxic chemicals and thus ideally suited for potable water applications. aquatherm green pipe can also be used for swimming pools, agriculture, shipbuilding, or the transport of chemicals. It is joined by using reliable heat fusion, which eliminates the hazards of welding and creates virtually leak-free connections.

The system includes the different types of pipes SDR 6, SDR 7.4, SDR 9 and SDR 11. More than 450 joining and connection elements as well as valves and ball valves complete the system.

The products are available from 16 mm to 450 mm external diameter.

SYSTEM COMPONENTS

The systems include all elements for the pipe system installation for chilled, hot fluid and various industrial applications.

- Pipes in straight lengths and / or coils
- Fittings
- Flanged joints
- Water point connections and accessories
- Welding devices and machines
- Weld-in saddles
- Manifolds
- Shut-off devices
- Cutting and peeling tools
- Installation guide and fastenings
- Transition joints from PP to metal or from metal to PP

APPLICATION AREAS

System recommended due to its technical advantages: ●

Application of the system is suitable: ○

aquatherm green pipe

Potable water application	●
Heating system construction	○
Air conditioning technology	○
Chilled water technology	○
Swimming pool technology	○
Chemical transport due to high chemical resistance*	●
Rainwater application	○
Irrigation	●
Compressed air systems	○
Underfloor heating systems	○
Shipbuilding	●
District heating and cooling	○
Geothermal	○
Agriculture	●

* For resistance requirements, information regarding the medium and operating conditions (operating pressure and operating temperature) are required. The corresponding inquiry form can be found on page 87.

aquatherm green pipe

Pipe system made of polypropylene
for potable water supply

SDR: 6
ø: 16–110 mm

Type of pipe:
aquatherm green pipe S

SDR: 7.4
ø: 16–63 mm

Type of pipe:
aquatherm green pipe S

SDR: 11
ø: 20–355 mm

Type of pipe:
aquatherm green pipe S

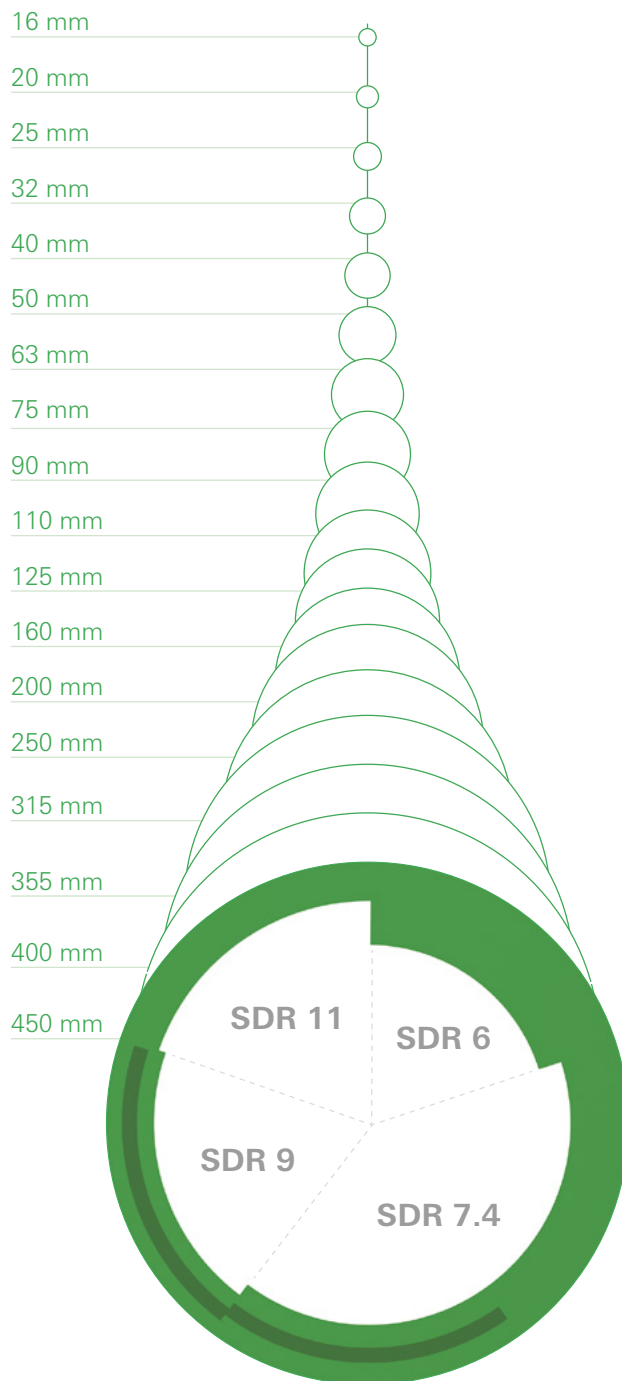

SDR: 7.4 / 9
ø: 20–355 mm

Type of pipe:
aquatherm green pipe MF / MF RP

SDR: 7.4 / 9
ø: 20–355 mm

Type of pipe:
aquatherm green pipe MF UV / MF RP UV

SDR: 9
ø: 32–355 mm

Type of pipe:
aquatherm green pipe MF RP ti



aquatherm green pipe SDR9 MF RP

aquatherm sets the innovation standard in the manufacture of polypropylene pipes and fittings worldwide. We are constantly striving to develop new, advanced materials and products. The current stage of material evolution is called fusiolen® PP-RCT.

With fusiolen® PP-RCT, fibre composite pipes can be produced with smaller wall thicknesses while maintaining all known advantages.

Advantages:

- Lower wall thickness
- 14 % higher flow rate at same velocity compared to fibre composite pipe SDR 7.4
- The permissible working pressures are on the same level like those of PP-R fibre composite pipes SDR 7.4 or are even exceeding them in the higher temperature range
- Identical expansion as fibre pipe SDR 7.4
- 16 % lower weight than fibre composite pipe SDR 7.4
- Lower weight than stainless steel, steel and copper pipes, thereby easier handling for transport and at site
- Quicker processing by shorter butt-welding times
- Can be welded with all aquatherm PP-R and PP-RCT fittings

COMPOSITE TECHNOLOGY

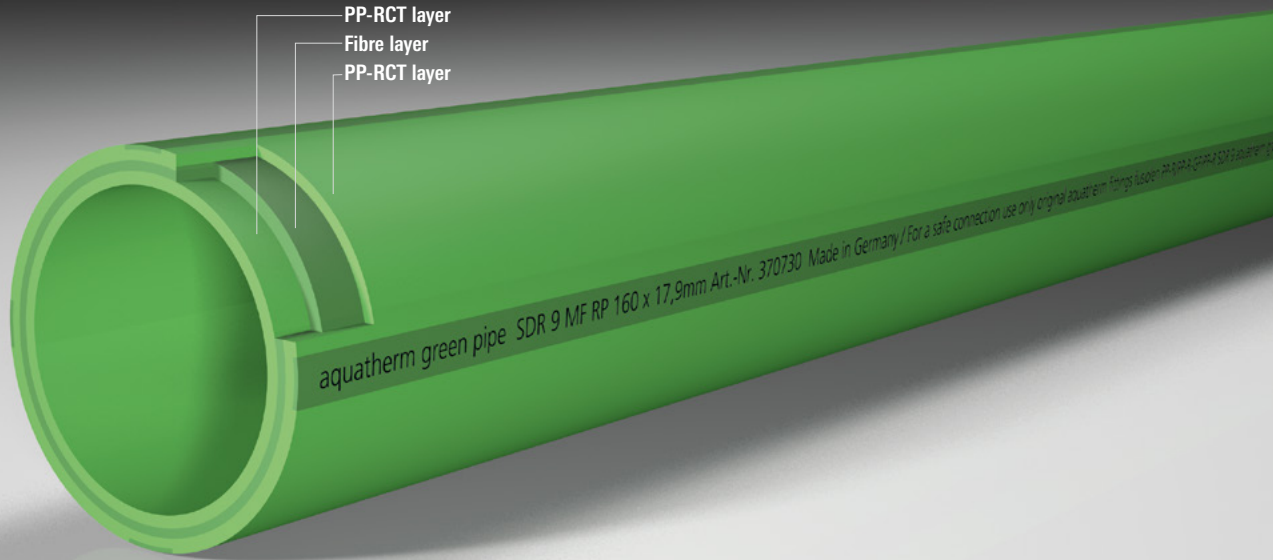

aquatherm green pipe MF

FIBRE COMPOSITE TECHNOLOGY

aquatherm green pipe MF is a multi-layer fibre-composite pipe. The pipe is made in a multi-layer extrusion process. The manufacturing process developed by aquatherm enables the integration of glass fibres within the material polypropylene in the middle layer of the pipe. This reinforces the pipe and restricts expansion and contraction.

Advantages of aquatherm green pipe MF:

- The linear expansion is reduced by at least 75 % compared with standard PP pipes
- The flow rate is increased by 20 % at the same pressure conditions due to smaller wall thicknesses
- High stability
- The coefficient of linear expansion is nearly identical to that of metal pipes so that compared with usual plastic pipes the support intervals can be enlarged and the number of clamps can be reduced
- Optimum cost-performance ratio
- Lower weight
- High impact rate
- Simply cut and weld

Expansion in comparison

Graph for determination of expansion

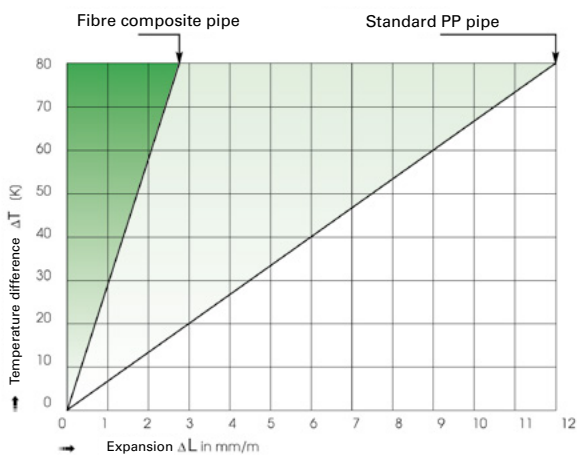

Support spacings PP pipe and fibre composite pipe

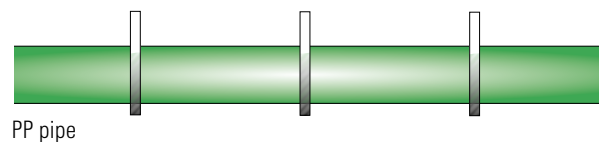

PP pipe



Fibre composite pipe approx. 30 % more fixing distance

aquatherm green pipe ti

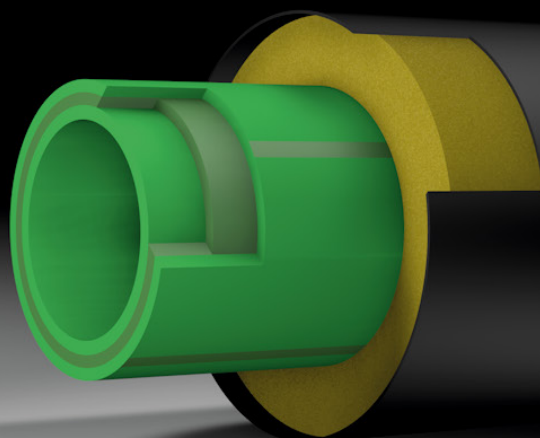

aquatherm ti

PRE-INSULATED PIPE SYSTEMS FOR DISTRICT HEATING AND COOLING

One of the most energy-efficient methods of transporting hot potable water as well as heating or cooling water over long distances is the use of underground piping. For this application, high demands are made on both the medium pipe and the pipe insulation. To achieve the necessary insulating characteristics for this type of application, aquatherm offers the factory-made pre-insulated aquatherm ti pipe system with different medium pipes.

The pipe insulation is made with PUR rigid foam that surrounds the medium pipe all over. To protect the insulation layer outward against mechanical or weather-related influences, the outside coating consists of a HDPE protection pipe.

All medium pipes are plastic-fibre composite pipes.

The pipe system is optionally also available with trace heating and mains monitoring. Special designs on request.

→ **aquatherm green pipe ti**
pipe system for potable water

- fibre composite pipe system SDR 9 in dimensions 32–355 mm
- fibre composite pipe system SDR 7.4 available on request

Application areas

aquatherm green pipe ti

Potable water application	●
Air conditioning technology	○
Chilled water technology	○
Swimming pool technology	●
Rainwater application	●
Irrigation	●
District heating and cooling	○
Shipbuilding	●
Industrial liquids considering the material resistance	●

System recommended due to its technical advantages: ●
Application of the system is suitable: ○

MORE INFORMATION

Further information on the aquatherm ti system can be found in our aquatherm ti catalogue with the order number E30000, which you can get from our info service (phone +49 2722 950 0 | infoservice@aquatherm.de) or you can download it from our website www.aquatherm.de.



aquatherm green pipe

POTABLE WATER AND HEATING INSTALLATIONS

The aquatherm green pipe system offers all installation options with an environmentally friendly material: from the house connection station via the hot or cold water distribution and the boiler connection to the last tapping point (in-wall or on-wall installation). Risers, designed in aquatherm green pipe composite pipe, with a conventional floor outlet or floor distribution in connection technique can also be implemented.

Types of installation

The aquatherm green pipe system is applicable for all common types of installation. With an extensive product range of pipe and fittings from 16–450 mm external diameter and more than 450 fittings including fittings with brass and stainless steel thread, aquatherm green pipe offers ideal solutions for all application areas.

It is also possible to prefabricate pipe and fittings for risers and laterals.



House connection station



Surface installation



Concealed installation



Surface installation

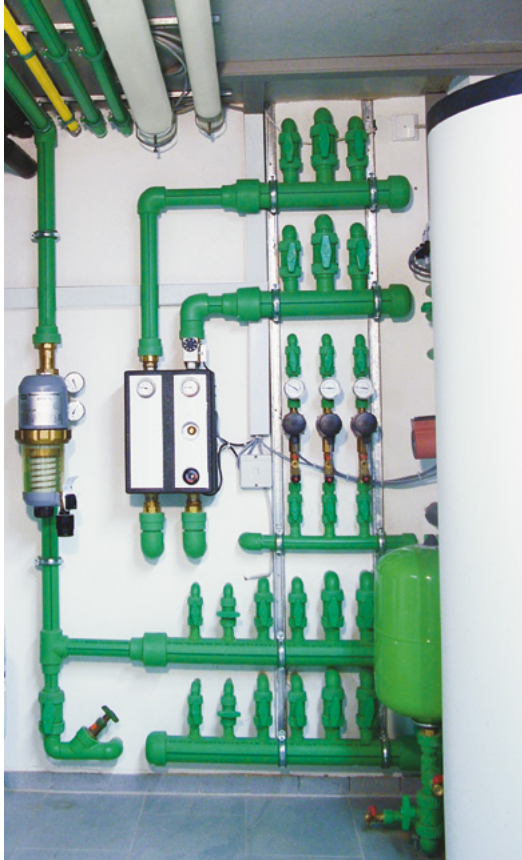

Distribution network for domestic water and heating in residential buildings

All risers and distribution pipes are planned and assigned as usual.

1. Distribution piping

The dimensionally stable straight length pipes should be used for conventionally installed basement pipes, risers and multi-storey pipe systems.

Multi-storey installation can be done with the distribution blocks for plumbing and heating: quick processing and low installation effort are guaranteed.

Due to the low need for fittings when using distribution blocks, the number of connection points and thus the installation work is reduced.

2. Floor distribution with distribution blocks

The distribution blocks also offer further installation options: A simple opening of a side branch by drilling (18 mm borer) enables the connection of an additional pipe, e.g. the circulation pipe.

For further information concerning the distribution block plumbing and heating see page 83–86.

IMPORTANT:

The aquatherm grey pipe domestic water and radiator connection system is compatible with the aquatherm green pipe system.



Distribution piping



Floor distribution with distribution blocks

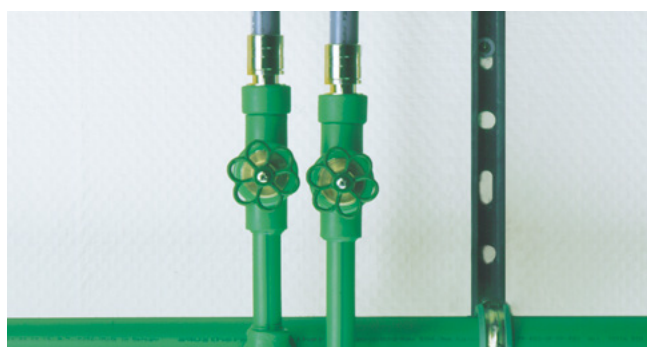

aquatherm grey pipe connection

COMPARISON OF THE WATER CONTENT PER METER [L]

Ø Dimension mm	aquatherm green pipe SDR 6 S	aquatherm green pipe SDR 7,4 MF	aquatherm green pipe SDR 9 MF RP	aquatherm green pipe SDR 11 S / MF
Ø 16	0,088	0,106	-	-
Ø 20	0,137	0,163	-	0,206
Ø 25	0,216	0,254	-	0,327
Ø 32	0,353	0,423	0,483	0,539
Ø 40	0,555	0,660	0,754	0,834
Ø 50	0,876	1,029	1,182	1,307
Ø 63	1,385	1,647	1,869	2,074
Ø 75	1,963	2,323	2,659	2,959
Ø 90	2,826	3,358	3,825	4,252
Ø 110	4,229	4,999	5,725	6,359
Ø 125	-	-	7,386	8,199
Ø 160	-	-	12,109	13,430
Ø 200	-	-	18,908	21,010
Ø 250	-	-	29,605	32,861
Ø 315	-	-	46,966	52,172
Ø 355	-	-	59,625	66,325
Ø 400	-	-	-	84,290
Ø 450	-	-	-	106,477
Ø 500	-	-	-	-
Ø 630	-	-	-	-

SDR = Standard Dimension Ratio (diameter/wall thickness ratio)

S = single-layer

MF = multi-layer fibre

MF RP = multi-layer fibre – raised pressure resistance

RING STIFFNESS OF aquatherm green pipe

All aquatherm polypropylene pipes have a ring stiffness of $\geq 16\text{ kN/m}^2$ (according to DIN EN ISO 9969) and therefore can be classified in the ring stiffness class SN16.

Underground installation: The depth of the trench adds up from the depth of the frost line, the outer diameter of the pipe and the height of the bedding ($A+D_a+B$). The frost line must be observed: 0.5–9.0 m above the pipe peak (E). If the pipes are installed outside the specified laying depth, a load distribution by steel or concrete slabs must be installed.

Traffic load: SLW 60, heavy forklift (60 tons maximum load).

Trench design: Recommended calculation according to ATV A 127 (basis for calculation).

Laying conditions: We recommend laying the pipes in a narrow trench in which nevertheless sufficient space for working is available.

Bedding layer (B): In normal soil 100 mm sand with round graining size 0–8 mm.
When rock or rocky soils 150 mm sand with round graining size 0–8 mm.
This layer is equally compressed ($\geq 97\%$ Proctor) with gaps in the socket area. Non sustainable soils are made stable by the choice of the bedding layer. Note planning requirements.

Backfilling: The building material 4/8 mm graining is filled in layers in order to construct the lateral bedding (C) and the covering (D). Thereby the peak of the pipe (E) is covered with minimum 100 mm. Then the main filling (F) with the excavation can be carried out. Note that the grain size does not exceed 300 mm respectively sharp and rough stones are removed. Planning requirements of the filling levels are always to be considered.
Each filling is compressed separately.

Compaction: The compression ($\geq 97\%$ Proctor) of the lateral bedding (C) and the covering (D) is done by hand or with light equipment. If the main filling is made with minimum 20 cm, the trench can be compressed 95 % Proctor upwards from this layer with heavy equipment. The last 50 cm of the trench are compressed with 97–100 % Proctor.

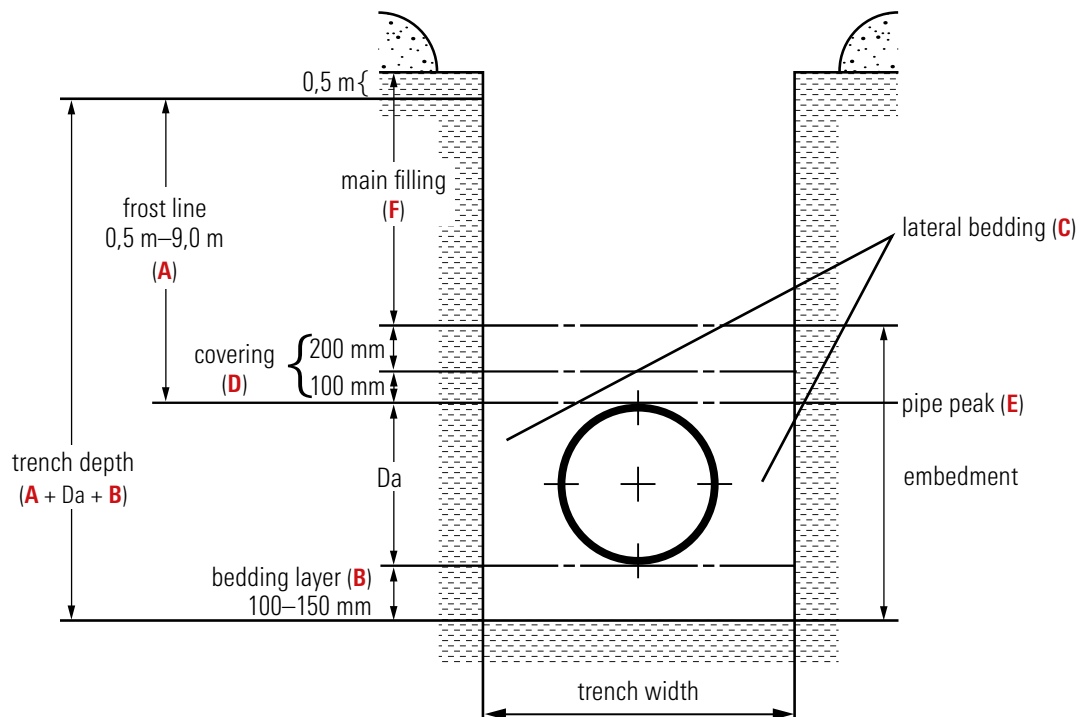

PERMISSIBLE WORKING PRESSURE – POTABLE WATER

Fluid transported: water according to DIN 2000

Temperature	Years of service	aquatherm green pipe SDR 11 S		aquatherm green pipe SDR 7.4 S		aquatherm green pipe SDR 6 S		aquatherm green pipe SDR 7.4 MF		aquatherm green pipe SDR 9 MF RP	
		Permissible working pressure in bar and (psi)									
		bar	(psi)	bar	(psi)	bar	(psi)	bar	(psi)	bar	(psi)
20 °C 68 °F	10	13,7	(199)	21,7	(315)	27,3	(396)	26,1	(379)	23,9	(347)
	25	13,3	(193)	21,1	(306)	26,5	(384)	25,3	(367)	23,5	(341)
	50	12,9	(187)	20,4	(296)	25,7	(373)	24,5	(355)	23,1	(335)
30 °C 86 °F	10	11,6	(168)	18,3	(265)	23,1	(335)	22,0	(319)	20,6	(299)
	25	11,2	(162)	17,7	(257)	22,3	(323)	21,3	(309)	20,2	(293)
	50	10,9	(158)	17,3	(251)	21,8	(316)	20,7	(300)	19,9	(289)
	40 °C 104 °F	10	15,6	(226)	19,6	(284)	18,7	(271)	17,7	(257)	
		25	15,0	(218)	18,8	(273)	18,0	(261)	17,3	(252)	
		50	14,5	(210)	18,3	(265)	17,5	(254)	17,1	(247)	
	50 °C 122 °F	10	13,1	(190)	16,5	(239)	15,7	(228)	15,1	(219)	
		25	12,6	(183)	15,9	(231)	15,2	(220)	14,7	(215)	
		50	12,2	(177)	15,4	(223)	14,7	(213)	14,5	(210)	
	60 °C 140 °F	10	11,0	(160)	13,8	(200)	13,2	(191)	12,7	(186)	
		25	10,5	(152)	13,3	(193)	12,6	(183)	12,4	(181)	
		50	10,1	(146)	12,7	(184)	12,1	(175)	12,2	(178)	
	65 °C 149 °F	10	10,4	(151)	13,1	(190)	12,5	(181)	11,7	(170)	
		25	10,0	(145)	12,6	(183)	12,0	(174)	11,4	(165)	
		50	8,8	(128)	11,1	(161)	10,6	(154)	11,2	(162)	
	70 °C 158 °F	10	9,3	(135)	11,7	(170)	11,1	(161)	10,7	(155)	
		25	8,0	(116)	10,1	(146)	9,6	(139)	10,4	(152)	
		50	6,7	(97)	8,5	(123)	8,1	(117)	10,2	(148)	
Fibre composite pipe: high working stress at lower wall thickness and higher flow rate											

SDR = Standard Dimension Ratio (diameter/wall thickness ratio)

S = single-layer

MF = multi-layer fibre

MF RP = multi-layer fibre – raised pressure resistance

The determination of the allowable pressures resulted from the specific conditions to which pipe system components in the potable water domestic installation are exposed to. Limiting factors such as increased flow rates, the use of disinfectants, increased content of oxygen, etc. were considered by the use of the appropriate safety factors. For fittings of butt-welded pipe segments a reduction factor of 0.75 (reduction of the table values by 25 %) is effective.

PERMISSIBLE WORKING PRESSURE

for general pressure pipe applications in permanent operation
 charted application ranges on page 20

Temperature	Years of service	aquathermgreen pipe SDR 7.4 MF		aquathermgreen pipe SDR 9 MF RP	
		bar	(psi)	bar	(psi)
10 °C 50 °F	10	27,7	(402)	27,5	(399)
	25	26,9	(390)	27,1	(393)
	50	26,1	(379)	26,7	(387)
	100	25,2	(366)	26,3	(381)
15 °C 59 °F	10	26,9	(390)	25,7	(373)
	25	26,1	(379)	25,2	(366)
	50	25,3	(367)	24,9	(361)
	100	24,5	(355)	24,5	(355)
20 °C 68 °F	10	26,1	(379)	23,9	(347)
	25	25,3	(367)	23,5	(341)
	50	24,5	(355)	23,1	(335)
	100	23,7	(344)	22,8	(331)
30 °C 86 °F	10	22,0	(319)	20,6	(299)
	25	21,3	(309)	20,2	(293)
	50	20,7	(300)	19,9	(289)
	100	20,0	(290)	19,7	(286)
40 °C 104 °F	10	18,7	(271)	17,7	(257)
	25	18,0	(261)	17,3	(251)
	50	17,5	(254)	17,1	(248)
	100	16,8	(244)	16,8	(244)
50 °C 122 °F	10	15,7	(228)	15,1	(219)
	25	15,2	(220)	14,7	(213)
	50	14,7	(213)	14,5	(210)
	100	14,1	(205)	14,3	(207)
60 °C 140 °F	10	13,2	(191)	12,7	(184)
	25	12,6	(183)	12,4	(180)
	50	12,1	(175)	12,2	(177)
70 °C 158 °F	10	11,1	(161)	10,7	(155)
	25	9,6	(139)	10,4	(151)
	50	8,1	(117)	10,2	(148)
75 °C 167 °F	10	10,0	(145)	9,7	(141)
	25	8,0	(116)	9,5	(138)
	50	6,7	(97)	9,3	(135)
80 °C 176 °F	5	9,2	(133)	9,0	(131)
	10	7,8	(113)	8,9	(129)
	25	6,2	(90)	8,6	(125)
90 °C 194 °F	5	6,0	(87)	7,4	(107)
	10	5,1	(74)	7,3	(106)

SDR = Standard Dimension Ratio (diameter/wall thickness ratio)

S = single-fibre

MF = multi-layer fibre

MF RP = multi-layer fibre – raised pressure resistance

For fittings of butt-welded pipe segments a reduction factor of 0.75 (reduction of the table values by 25 %) is effective.

UV-RESISTANCE

Pipes made from fusiolen® polypropylene are normally not exposed to UV-radiation during installation. To bridge the transport and assembly time, aquatherm polypropylene pipes and fittings are packed in UV-protected packaging. The maximum permissible storage time outdoors is 6 months.

For outdoor pipe laying, aquatherm offers polypropylene composite pipes with a UV protective layer made of polyethylene. The special protection layer prevents damages from sunlight. The pipes are available under the name aquatherm green pipe MF (RP) UV.

UV ADHESIVE TAPE

As an alternative to our polypropylene pipes with UV protection layer, wrapping with UV-resistant adhesive tape is possible, if moulded parts or short pipe sections are to be protected. For this purpose, the adhesive tape recommended by aquatherm (art. no. 10871) should be selected, which shows good resistance to abrasion, moisture, oils, light acids and alkalis as well as weather influences outdoors. The tape should always be applied to a dry, clean and grease-free surface. The winding should be done with a slight pull and at least 50% overlap.

Further information on page 120.

CHEMICAL AND THERMAL DISINFECTION

of aquatherm potable water systems made of polypropylene

a) Chemical disinfection of the system

Contrary to the disinfection of potable water, the disinfection of a system is a discontinuous measure, comprising a potable water system from the area of contamination to the tapping point of the consumer. In general, a disinfection is to be applied temporarily only in case of a proven contamination.

In case of **discontinuous** disinfections, it is allowed to load aquatherm pipes and the corresponding fittings twice a year with a content of free chlorine of 50 mg/l for not more than 12 hours.

Alternatively, 150 mg/l hydrogen peroxide (H₂O₂) can be used for 24 hours. A temperature of 30 °C must not be exceeded during the disinfection process. The use of a disinfection process, especially with chlorinated waters can have a direct influence on the lifetime of the potable water system. Under no circumstances should chlorine dioxide be used.

b) Chemical disinfection of potable water

In case of **continuous** disinfection with chlorinated potable water, it can be used with a content of free chlorine of up to 0.3 mg/l (limit according to 2001 potable water ordinance). The maximum temperature of 70 °C should not be exceeded.

Unless required by local regulations, residual disinfection is not necessary where there is no evidence of bacterial water contamination.

Under no circumstances should chlorine dioxide be used.

Recommendation of the World Health Organization – Guidelines for potable water quality, fourth edition

For effective disinfection, there should be a residual concentration of free chlorine of ≥ 0.5 mg/l after at least 30 min contact time at pH < 8.0. A chlorine residual should be maintained throughout the distribution system. At the point of delivery, the minimum residual concentration of free chlorine should be 0.2 mg/l.

c) Thermal disinfection of the system

In general, a thermal disinfection according to DVGW W551 is possible. In case of the thermal disinfection for the prevention of legionella bacteria according to DVGW worksheet W 551, the water temperature will be adjusted in such a way that it amounts to 70 °C for at least 3 minutes at all points of the potable water system. The maximum admissible limits of use regarding the service temperature and pressure are to be observed.

INTEGRATION OF OTHER SYSTEMS OR COMPONENTS WITH AQUATHERM PIPING FOR PRESSURE PIPE APPLICATIONS

When integrating aquatherm piping systems with other systems or components not made of polypropylene (e.g. valves, pumps, other piping, check valves, strainers, etc), care must be taken to ensure the operating parameters for polypropylene won't damage the other materials or vice versa.

Be aware that even if the aquatherm pipe is compatible with the fluid being transported, other materials in the system may not be. All parts of the system must be verified as compatible with the medium being carried before installing them. And, while the aquatherm pipe does not require treatment to protect it from corrosion, metals (ferrous and non-ferrous) in the system may be susceptible to corrosion.

Do not mix the aquatherm pipe with other piping systems in conditions that will cause the other system or components to fail.

DOMESTIC HOT WATER RECIRCULATION (DHWR)

A hot water circulation system includes all components that are in contact with the circulating water, including the flow and return supply. When there is copper piping used in conjunction with PP-R/PP-RCT in a DHWR system, care should be taken to ensure the operating conditions will not cause degradation or erosion/corrosion of the copper. aquatherm recommends following the Copper Development Association guidelines (CDA Publication A4015-14/16: The Copper Tube Handbook – www.copper.org) for sizing, temperature and flow velocity in copper tubing. This will also help ensure that the copper levels in the water do not approach the regulatory action levels recommended by independent institutions (e.g. U.S. Environmental Protection Agency (EPA), World Health Organization (WHO), Federal Ministry of Justice and Consumer Protection of Germany). Sustained high levels of copper in DHWR piping can damage components within the system, even PP-R. **Damage caused by copper in the water resulting from erosion/corrosion or other degradation of copper components in the DHWR system will void the aquatherm warranty.**

Accordingly, and as mandated by various regulations and codes in DHWR systems, it is considered good design and operational practice to ensure that the maximum HW-temperature within any part of the system / loop does not exceed 60 °C (140 °F). Some regulations and codes further restrict the temperature at any fixture to a maximum of 50 °C (120 °F). There are some exceptions to this such as the process of thermal disinfection in health care facilities where temperatures of 70 °C (160 °F) or higher can be applied for short periods of time throughout the pipe system.

Importantly, the maximum temperature used must not exceed the rating of the pipe for the operating pressure. (See aquatherm green pipe catalogue – table: permissible working pressure potable water – Fluid transported: water according to DIN 2000)

According to some regulations and codes, flow rates in a DHWR system should not exceed 0.5 m/s (1.5 ft/sec) anywhere in the system, except in some special cases where velocities up to 1 m/s (3 ft/sec) are needed to achieve proper flow temperature. The CDA Publication A4015-14/16 – The Copper Tube Handbook – limits the velocity in DHWR system to similar rates.

When re-piping an existing DHWR-system originally installed in copper tubing, ensure all possible copper is replaced. If some copper remains as part of the system, strictly follow the rules and guidelines of the Copper Development Association (CDA Publication A4015-14/16: The Copper Tube Handbook) regarding flow rates and water conditions. Small amounts of copper or brass in valves and other equipment will generally not cause an issue. If the copper fails, it may degrade o-rings, gaskets, PP-R and other components as well, shortening their service life.

When adding PP-R/PP-RCT to an existing copper system in a DHWR-application, the level of copper in the water should be tested. These levels should not exceed 0.1 mg/L (ppm). Higher levels of total copper indicate that the copper pipe is corroding/eroding due to system and/or water conditions.

To hydraulically balance a DHWR-system and ensure the required flow rate for each area of the building, it is necessary to install hydraulic-balancing-valves in every circulating loop throughout the complete system. This also maintains the flow velocity in the smaller return piping at or below the manufacturer's or CDA's recommendations.

In addition to sizing the piping and pumps to the correct flow velocity, care must also be taken to avoid water hammer and excessive surge pressures. Pump systems operating with on/off cycling, or pumps over-sized for the piping, can create high pressure and fatigue the piping material. The pump total dynamic head (TDH) must also be matched to the flow requirements, piping layout, and operating conditions to avoid cavitation for all components throughout the system. Cavitation can lead to excessive system noise and more importantly, can result in the erosion and degradation of the pipe surface and other components. Properly sized variable-speed (VFD) constant pressure pumping systems and pressure-sustaining valves can alleviate these issues. The pumps should be sized to operate at maximum efficiency with the lowest energy usage for the required flow rate.

The issues described here are only of concern in DHWR-systems. For domestic cold water (DCW) and mechanical (heating-cooling)-systems no additional requirements or actions are necessary. In some situations, the DHWR system is also used to provide hot water to the mechanical heating system. Additional consideration and care must be given for this type of combined system, as the mechanical components may not be compatible with the more aggressive water conditions and flow velocity limitations of DHWR systems, and these components may be not suitable for potable water contact.

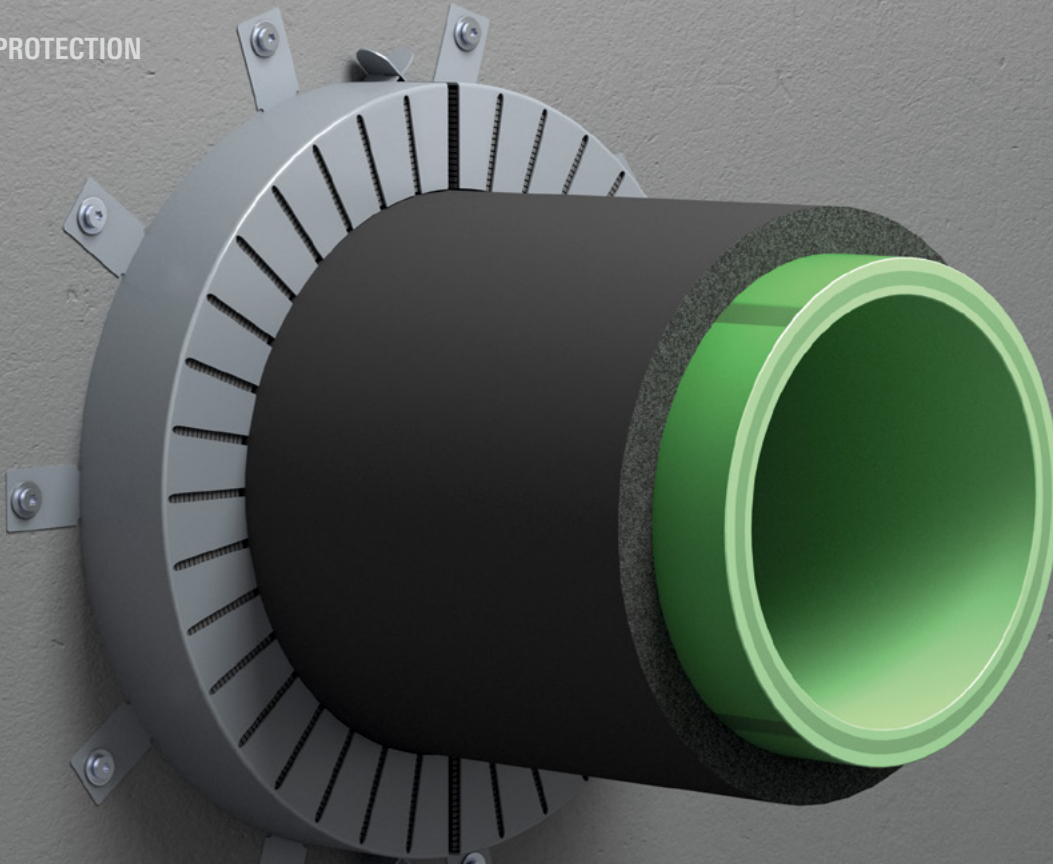

FIRE PROTECTION

The aquatherm polypropylene pipe systems comply with the requirements of the fire classification B2 DIN 4102 (normal inflammable). Compared to natural products like wood, cork or wool, aquatherm PP-R pipes do not produce any gas toxicity. In case of fire, there is no risk of dioxin emissions.

To avoid fire and smoke transmission aquatherm advises the use of fire retardant seals. The fire resistance period is the minimum period in minutes.

The extent of the preventive measures depends on the type of installation. The determination of fire areas and fire classification has to be made in accordance with the law of the country. Information is given by the Planning Department and Building Control Office or the Fire Protection Representative.

Basically, fire walls and ceilings with pipe passages have to be according to the same fire resistance classification. All fire protection systems with a corresponding classification are suitable for aquatherm polypropylene pipes.

The following companies offer suitable fire protection solutions:

Fire protection pipe shell Conlit 150 U:

DEUTSCHE ROCKWOOL GmbH & Co. KG

Rockwool Straße 37-41
45966 Gladbeck, Germany
Phone: +49 2043 408 0 · Fax: +49 2043 408 444
www.rockwool.de

Fire protection sleeve AWM II:

Flamro Brandschutz Vertriebs GmbH

Am Sportplatz 2
56291 Leiningen
T +49 6746 9410-0
E info@flamro.com
W flamro.de

Hilti Deutschland AG

Hiltistrasse 2
86916 Kaufering, Germany
Phone: +49 800 888 55 22
www.hilti.de

Roku System AWM II in the wall

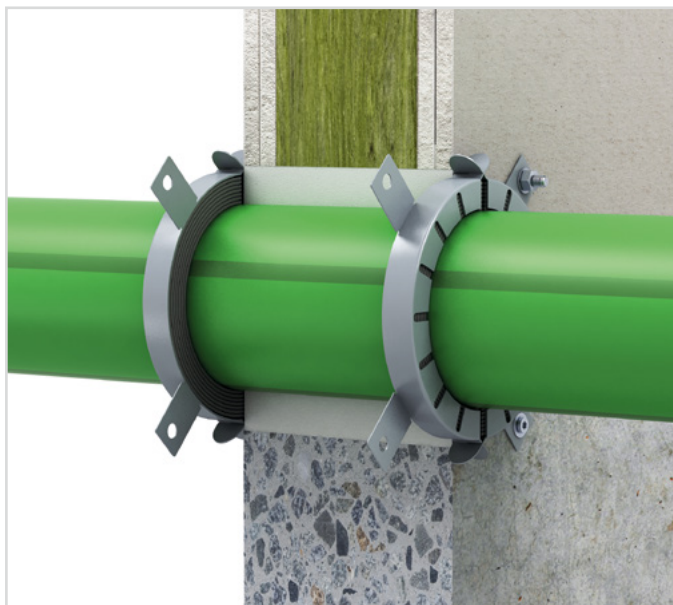

Roku System AWM II in the ceiling

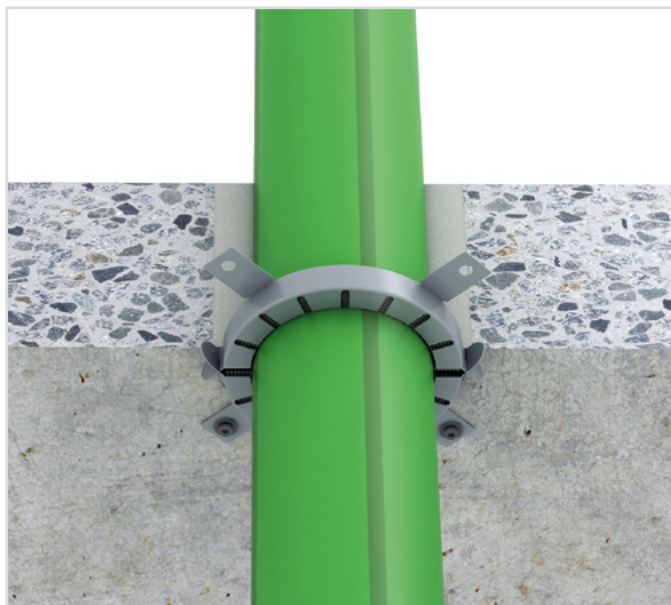

Roku System AWM II with synthesis rubber in the wall

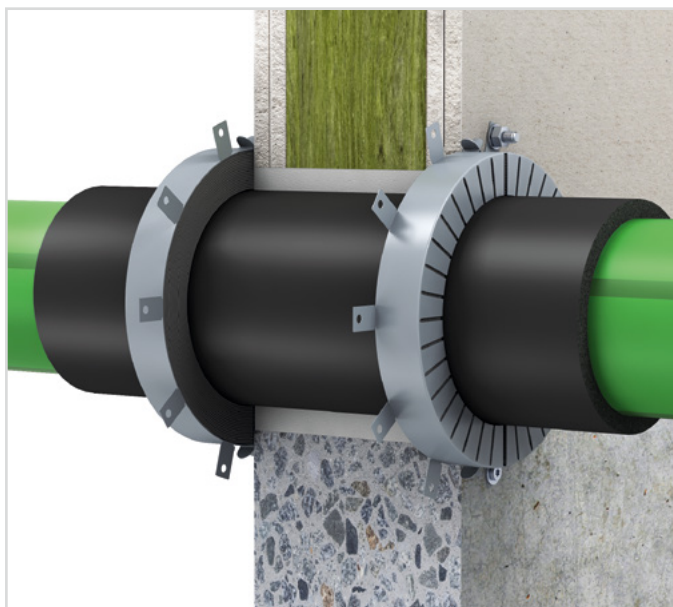

Roku System AWM II with synthesis rubber in the ceiling

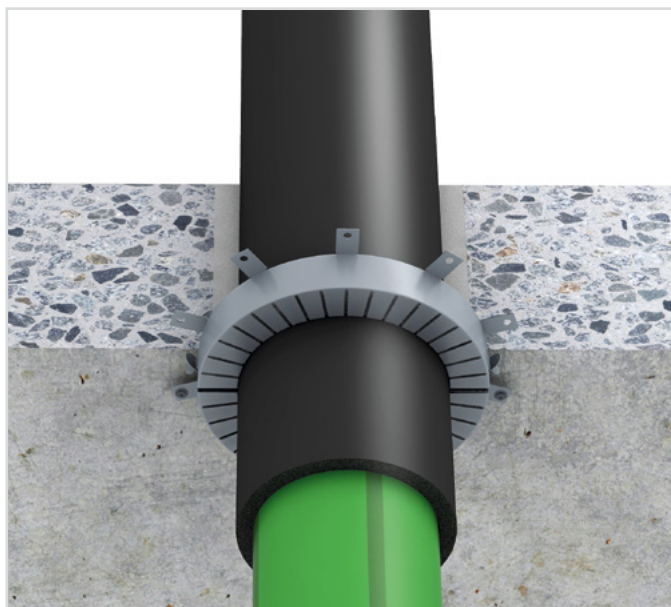

Rockwool Conlit 150 U in the wall

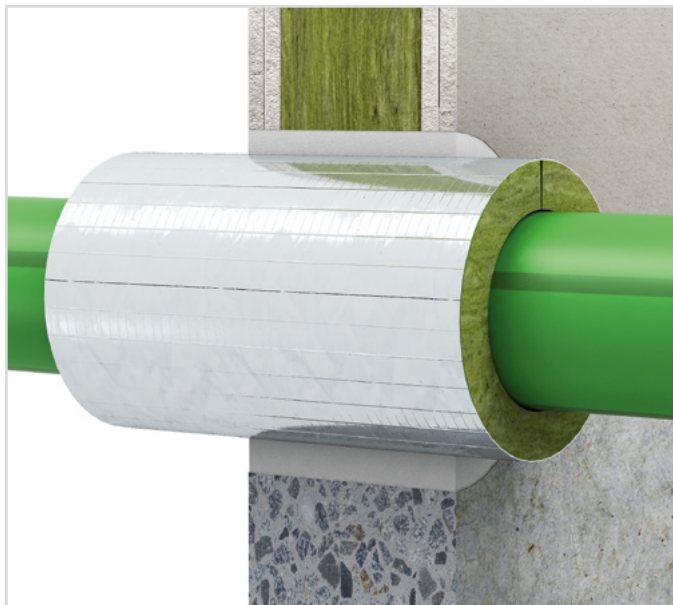

Rockwool Conlit 150 U in the ceiling

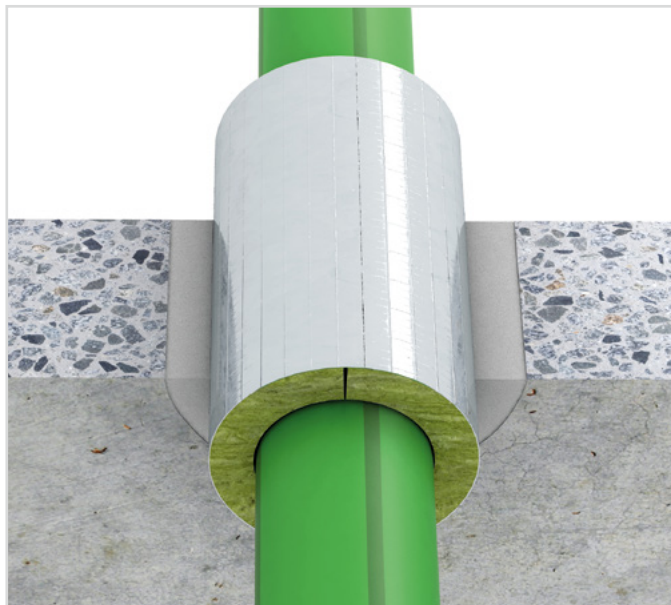

EXCERPT FROM THE ROCKWOOL PLANNING AND INSTALLATION AID

R 30- to R 90 pipe penetrations for the aquatherm installation systems with non-combustible media, such as potable water, heating, cooling

Product name / Material

aquatherm green pipe

PP-R
SDR 6 S,
SDR 7.4 S,
SDR 7.4 MF,
SDR 7.4 MF UV,
SDR 11 S

aquatherm green pipe

PP-RCT
SDR 9 MF RP,
SDR 9 MF RP UV

aquatherm blue pipe

PP-R
SDR 7.4 MF,
SDR 7.4 MF OT,
SDR 7.4 MF UV,
SDR 11 S

aquatherm blue pipe

PP-RCT
SDR 9 MF RP,
SDR 9 MF RP OT,
SDR 9 MF RP UV,
SDR 11 MF RP,
SDR 11 MF RP OT,
SDR 11 MF RP UV

aquatherm red pipe

PP-R (B1)
SDR 7.4, MF HI

aquatherm grey pipe

PE-Xc/Al/PE-X
SDR 7.4

aquatherm black system

PP-grid connection pipe

aquatherm orange

system

PE-RT

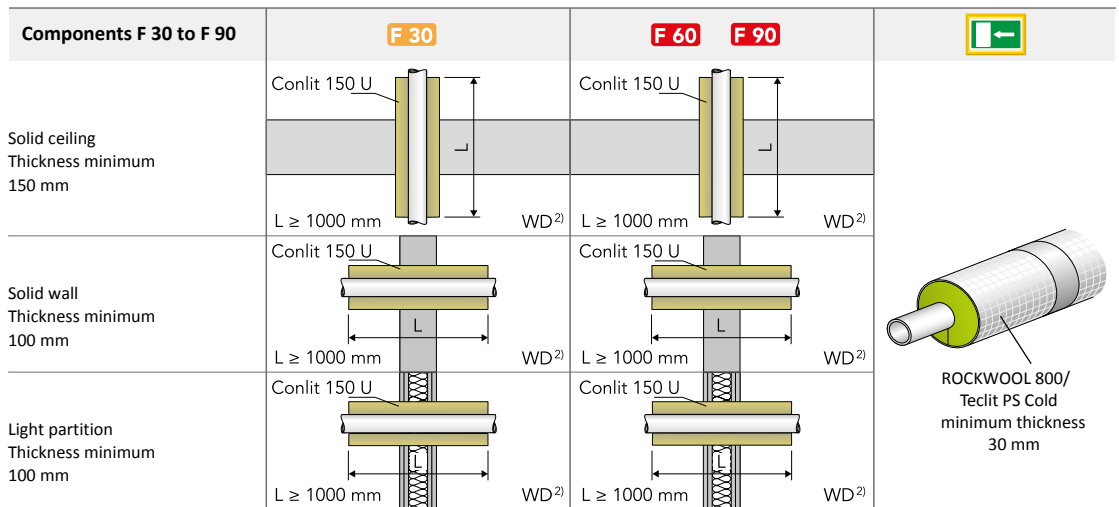

Variant according to ROCKWOOL abP P3726/4140MPA BS.

System	Pipe dimension	Conlith 150 U			ROCKWOOL 800 ^{1), 2), 3)} TECLIT PS Cold ^{1), 2), 3)}			
		Outer diameter Da [mm]	Type ³⁾	Insulation thickness ⁴⁾ s [mm]	Core drilling DK [mm]	EnEV 100 % hot, type	EnEV 50 % hot, type	DIN 1988 cold, type ³⁾
pipes without OT or UV layer	14,0	12/24	24,0	60	15/20	15/20	15/20	
	16,0	16/22	22,0	60	18/20	18/20	18/20	
	17,0	17/21,5	21,5	60	18/20	18/20	18/20	
	20,0	20/20	20,0	60	22/20	22/20	22/20	
aquatherm green pipe	25,0	25/17,5	17,5	60	28/20	28/20	28/20	
aquatherm blue pipe	26,0	26/17	17,0	60	28/20	28/20	28/20	
aquatherm red pipe	32,0	32/24	24,0	80	35/30	35/20	35/30	
aquatherm grey pipe	40,0	40/20	20,0	80	42/40	42/20	42/40	
aquatherm black system	50,0	50/25	25,0	100	54/40	54/30	54/40	
aquatherm orange system	63,0	63/33,5	33,5	130	64/50	64/30	64/50	
pipes with OT or UV layer	75,0	75/52,5	52,5	180	76/70	76/40	76/70	
	90,0	90/65	65,0	220	102/80	102/40	102/80	
	110,0	110/70	70,0	250	114/100	114/50	114/100	
	16,0	18/21	21,0	60	18/20	18/20	18/20	
pipes with OT or UV layer	20,0	22/19	19,0	60	22/20	22/20	22/20	
	25,0	27/16,5	16,5	60	28/20	28/20	28/20	
	32,0	34/23	23,0	80	35/30	35/20	35/30	
	aquatherm green pipe UV	40,0	42/19	19,0	80	42/40	42/20	42/40
	50,0	52/24	24,0	100	54/40	54/30	54/40	
	aquatherm blue pipe OT + UV	63,0	65/57,5	57,5	180	76/50	76/30	76/50
	75,0	77/51,5	51,5	180	89/70	89/40	89/70	
	90,0	90/65	65,0	220	102/80	102/40	102/80	
110,0	113/53,5	53,5	220	114/100	114/50	114/100		

Notes/special installation conditions

- ¹⁾ In some cases, the available minimum insulation thickness is specified.
- ²⁾ For further insulation, the insulation ROCKWOOL 800 or TECLIT PS Cold can be used.
- ³⁾ For cold pipes, a vapor barrier must be available according to DIN 1988-200, therefore only use fire protection pipe shell Conlith 150U/ Insulating shell ROCKWOOL 800 or TECLIT PS Cold.
- ⁴⁾ Insulation thickness according to EnEV 50% and according to DIN 1988 - 200 suitable for the core bore diameter DK.

All basic conditions of the specified general building inspectorate test certificates must be considered.

FIRE LOAD

The values required for determining the fire load within a fire section are calculated from the total of all flammable materials located within this area. The calculation for establishing the combustion heat V [kWh/m] for a fire section in the event of an outbreak is dependent on dimensions and materials.

The basis used for the calculation of polypropylene pipe systems is the lower calorific value $H_u = 12.2$ kWh/kg (as per DIN V 18230 T1) in conjunction with the mass of material m_{pipe} [kg/m].

The integrated layers of fibres in the aquatherm fibre composite pipes are also considered.

Depending on the calculation procedure, the fire load is worked out with reference to the burn-up factor. This value is designated as m_{factor} and is taken as 0.8 for polypropylene.

Combustion values V [kWh/m] for aquatherm green pipe

Dimension mm	aquatherm green pipe SDR 11 S	aquatherm green pipe SDR 7.4 S	aquatherm green pipe SDR 6 S	aquatherm green pipe SDR 9 MF RP	aquatherm green pipe SDR 7.4 MF	aquatherm green pipe SDR 11 MF
16	-	1,17	1,5	-	-	-
20	1,32	1,82	2,12	-	1,76	-
25	2,01	2,83	3,27	-	2,74	-
32	3,18	4,54	5,33	3,12	4,39	3,14
40	5,05	7,05	8,24	5,69	-	4,83
50	7,82	10,99	12,77	8,80	-	7,48
63	12,35	17,28	20,26	14,03	-	11,82
75	17,21	24,58	28,68	19,71	-	16,48
90	24,92	35,21	41,22	28,41	-	23,86
110	36,89	52,68	61,45	42,17	-	35,33
125	47,91	-	-	54,38	-	45,83
160	78,28	-	-	88,90	-	74,88
200	121,89	-	-	139,00	-	116,64
250	189,59	-	-	216,18	-	181,42
315	313,54	-	-	343,66	-	285,82
355	381,86	-	-	436,33	-	362,93
400	505,08	-	-	-	-	460,78
450	639,28	-	-	-	-	583,21
500	-	-	-	-	-	-
560	-	-	-	-	-	-
630	-	-	-	-	-	-



The advantages

of aquatherm pipes and fusiolen® polypropylene

- Corrosion resistant
- Resistant against many chemicals
- High environmental compatibility
- Less pipe roughness
- Heat and soundinsulating characteristics
- Very good welding properties
- High heat-stabilized
- High mechanical stability
- Lighter in weight than steel and copper
- Easy processing
- Well-priced
- Installation aids and fixings

fusiolen®

OUR MATERIAL FUSIOLEN® POLYPROPYLENE

Decades of experience in the manufacture and use of PP-R/PP-RCT piping systems and the simultaneous striving for continuous further development have led to numerous improvements in aquatherm system technology.

Newly opened markets place ever increasing demands on the pipe material. Versatile applications require the greatest possible independence of the processed materials. Raw materials with novel properties that could not be achieved until then are required. For this reason, aquatherm has been developing and producing its own innovative polypropylene materials for several years, which meet the global challenges in sanitary and heating technology, in air-conditioning and refrigeration technology, in industrial applications and agriculture, in shipbuilding and in fire protection. Successful results of this research are fusiolen® PP-R, fusiolen® PP-RCT and fusiolen® PP-R FS.

Special heat and extraction stability are only two of the features of this material. Its physical and chemical properties are tailored to the special needs of potable water and heating applications. Above all, the good welding properties and the fusion into a homogeneous unit, resulting in a permanent connection, have made the aquatherm systems and the raw material fusiolen® polypropylene well known worldwide.

Environment

The environmentally friendly material polypropylen fusiolen® PP-R/PP-RCT is recyclable and can be ground, melted and reutilised for various applications e.g. motor-protections, wheel linings, laundry baskets and other kinds of transport boxes. There are no polluting substances with PP-R/PP-RCT either in its processing or in its disposal.

fusiolen® PP-R/PP-RCT – for the benefit of our environment!

Use of metal deactivators

By adding suitable food-approved additives the risk of material damage caused by metal ions under extreme operating conditions is reduced.

Higher long-term heat stabilization

The long-term heat stabilization was increased in order to be able to counteract possible influences of the peak temperatures occurring during operation.

MATERIAL PROPERTIES

Potable water is one of the most controlled commodity goods. The supply system should influence the water on its way up to the taps as less as possible. The choice of the right potable water pipe system and its material is of decisive importance.

aquatherm green pipe systems are suitable for all different qualities of potable water. The environmentally friendly and hygienically enhanced potable water pipe system made from fusiolen® is physiologically and microbiologically harmless. The technical suitability of the aquatherm pipe systems has been evident worldwide for decades.

The extrapolated service life of aquatherm polypropylene pipes is more than 50 years. Peak temperatures of 100 °C arising from short disruptions are unproblematic. Permanent temperatures from 70 °C up to 90 °C reduce the service life of the pipe (see table "Permissible Working Pressure", page 20–21).

When using aquatherm PP-R/PP-RCT pipes, the pressure and temperature conditions according to the table "Permissible working pressure" apply. With regard to pressure and temperature, the operating conditions in the following table are to be used for pipes and pipe connections. These figures refer to potable water installations based on a theoretical service life of 50 years.

	Working pressure bar (psi)	Temperature °C	Annual working hours h/a
Cold water	0 up to 10 (145) transient	to 25 (77) *	8760
Hot water	0 up to 10 (145) transient	to 60 (140) to 85 (185)	8710 50

* Reference temperature for the creep rupture strength: 20 °C (68 °F)

HYGIENIC SUITABILITY

According to DIN 1988 T2 all installation parts coming directly in contact with potable water are commodity goods according to the Law for Food and Commodity Goods. Plastic pipes have to comply with the KTW-recommendations of the Federal Public Health Department.

Certificates

Numerous international certificates testify to the high quality standard of the green pipes.

- DVGW, SKZ, HIG** (Germany)
- AENOR** (Spain)
- ÖVGW** (Austria)
- WRAS** (UK)
- SAI-Global** (Australia)
- CSTB, CARSO** (France)
- SII** (Israel)
- TIN** (Poland)
- SITAC, KIWA, SWEDCERT** (Sweden)
- IIP** (Italy)
- BNQ** (Canada)
- BRANZ** (New Zealand)
- CERTIF** (Portugal)
- EMI** (Hungary)
- a.m.m.**



Material:

The hygienic suitability of the material used for the aquatherm green pipe system is independently verified through test certificates from the Hygienic Institute in Gelsenkirchen. The suitability for potable water pipes in the field of cold and hot water is confirmed by continuous tests.

Processing:

The joining method requires no additives such as fluxes or solder. The connection is made by socket fusion.

Potable water – our most precious commodity good:

The increasing use of PP in the field of food packing confirms the hygienic qualities of the material. This makes aquatherm green pipe the optimal packing for our most precious commodity good – potable water.

SOUND INSULATION

The sound insulation qualities of the PP-R-pipe system, related to water flow and hydraulic shock within a building, provide a sound proofing effect on noise transmission. Therefore the sound transmission is much lower compared to metallic pipes.

AQUATHERM & ECOLOGY

Environmental protection is very important to aquatherm. The aquatherm pipe systems and fittings are not only characterized by their long service life, but also by their excellent environmental compatibility. Since its foundation, aquatherm has been attaching great importance to the fact that its products and manufacturing processes do not pollute our sensitive ecosystems. Through the development of recyclable materials, it is possible that these can easily be fed into new productions.

Long before environmental protection was regarded as a global issue, the aquatherm green pipe system met the ecological standards that are required today. For more than 45 years, the aquatherm philosophy has emphasized that ecological and economical interests in production, distribution and application of a product are not contradictory.

The environmentally friendly raw material fusiolen® is used for the production

of the aquatherm pipe systems. To ensure its environmental compatibility

the basic material polypropylene, as well as all contained additives (colour pigments and stabilizers) were extensively tested, not only by aquatherm's own laboratory, but also by independent laboratories.

The test results prove that the material fusiolen® and the piping systems made from it meet the highest ecological standards.

TECHNICAL DATA SHEET

Technical properties	fusiolen® PP-R	fusiolen® PP-R/PP-RCT fibrepipes
Melt-flow index 190 °C/5 kg	0.5 g/10 min	0.5 g/10 min.
Melt-flow index 230 °C/2.16 kg	0.3 g/10 min	0.3 g/10 min.
Modulus of elasticity	800 N/mm ²	1200 N/mm ²
Yield stress	25 N/mm ²	30 N/mm ²
Density	0.9 g/cm ³	1.0 g/cm ³
Tensile strength	25 MPa	35 MPa
Inflammation temperature	430 °C–450 °C	490 °C–500 °C
Thermal expansion coefficient	1.5 *10 ⁻⁴ K ⁻¹	0.35 *10 ⁻⁴ K ⁻¹
Coefficient of thermal conduction	0,15 W/mK (measured at pipe)	0,15 W/mK (measured at pipe)
Coefficient of friction in pipes	0.007	0.007
Bending radius	6 x d	
Water absorption	< 0.02 %	< 0.02 %
Electrical properties	fusiolen® PP-R	fusiolen® PP-R/PP-RCT fibrepipes
Relative permittivity	2,3 (in case of 1 MHz)	2,3 (in case of 1 MHz)
Puncture voltage	500 kV/cm	500 kV/cm
Specific resistance	> 10 ¹⁷ Ω cm	> 10 ¹⁷ Ω cm
Surface resistance	10 ¹⁴ Ω	10 ¹⁴ Ω
Dissipation coefficient	0.0002 (in case of 50 Hertz)	0.0002 (in case of 50 Hertz)

ENVIRONMENTAL PRODUCT DECLARATION AND LEED CERTIFICATION

As the world's first pipe system manufacturer, aquatherm has developed an Environmental Product Declaration (EPD) for its products. Thus the aquatherm products contribute to the attainment of points in the LEED system. Learn more about the importance of life cycle assessments, environmental product declarations and LEED for planners, engineers and builders.

Life-Cycle Assessments (LCAs)

LCAs provide a comprehensive evaluation of the upstream and downstream energy and environmental impacts associated with a product. They are comprised of five parts: Goal, Scope, Life-Cycle Inventory Analysis, Results, and Interpretation. aquatherm has chosen the cradle-to-gate approach for its LCA „Life Cycle of Polypropylene Pressure Piping Systems“ encompassing the product life cycle from the extraction of raw materials through manufacturing and product distribution.

Environmental Product Declarations (EPDs)

The EPD is the document used to convey the LCA's results to the products' users and specifiers. It focuses on information about a product's environmental impact such as global warming, ozone depletion, water pollution, ozone creation, and greenhouse gas emissions.

EPDs typically are verified following the processes described in ISO 14025, EN 15804, and ISO 21930 for construction products. These steps include: 1) Finding or developing a Product Category Rule (PCR); 2) Generating the input data and performing an LCA according to a specific PCR; 3) Compiling information in the EPD; 4) Verification of the EPD and LCA; and 5) Registration and publication.

aquatherm utilized ThinkStep as independent third party to conduct an ISO-conformant LCA for its following product lines: aquatherm had an ISO-compliant life cycle assessment carried out by ThinkStep as an independent third party for the following product lines: aquatherm green pipe, aquatherm blue pipe, aquatherm red pipe, aquatherm lilac pipe (no longer available) and the aquatherm black system for surface heating and cooling. In the study, one meter (3.2 ft) length of pipe was selected as functional unit per the requirements of the respective PCR "Piping Systems for Use for Sewage and Storm Water (Under Gravity)". The declared product was defined as a representative average of the five aquatherm product offerings.

Two different test methodologies were chosen to analyze the products in the LCA: Tool for Reduction and Assessment of Chemical and Other Environmental Impacts (TRACI) 2.1 and CML 2001, a method developed by the Institute of Environmental Sciences at the University of Leiden in the Netherlands. The TRACI 2.1 method utilized impact categories, including Global Warming Potential (GWP), Acidification Potential (AP), Eutrophication Potential (EP), Ozone Depletion Potential (ODP), and Smog Formation Potential (SFP). The results of the findings are summarized in the following table.

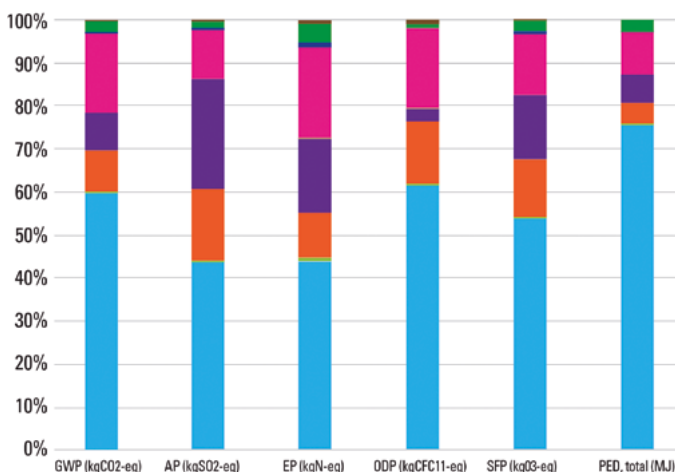

Environmental impacts and Primary Energy Demand of aquatherm PP-R piping systems according to TRACI 2.1

Upon completion of the aquatherm product-specific LCA, aquatherm submitted its products, the LCA, and supporting documentation for independent verification by NSF International. The verification process included a review by an independent panel of experts, an audit of the manufacturing facilities and records, and a confirmation of material formulations. aquatherm's Product-Specific Type III third-party verified EPD was published Dec. 18, 2015: <http://info.nsf.org/Certified/Sustain/ProdCert/EPD10069.pdf>

Within the EPD, you will find information on aquatherm, its product descriptions, data quality requirements, raw-materials origins, a manufacturing diagram, a declaration of parameters per the PCR, and the lifecycle-impact conclusion for aquatherm pipe.

Advantages of PP-R piping systems and radiant panels compared to metal systems

The analysis has shown that polypropylene comprises nearly 50% or more of the impact contribution depending on the impact category. Also Primary Energy Demand (PED) is mainly driven by polypropylene. However, this is because of the embodied energy content of the resin rather than fuel consumption upstream. In other words, aquatherm polypropylene has available energy within the material that can be recovered later in the product's life cycle during recycling. This differs greatly compared with metals. With metal systems, all of the energy is used in the original processing of the raw material. Metals do not provide energy to the recycling process.

Thus aquatherm PP-R piping systems and radiant panels can provide a more sustainable, lower environmental impact option to designers, engineers, and building owners when compared with other piping and radiant panel systems.

How is aquatherm's EPD relevant to LEED v4 points?

LEED stands for „Leadership in Energy and Environmental Design“ and is one of the most popular green building certification programs used worldwide. It was developed by the U.S. Green Building Council (USGBC) in 1998 and has defined various standards for environmentally friendly, resource-saving and sustainable construction.

LEED v4 incorporates point structures to encourage the use of products/ materials that environmentally, economically, and socially support preferable life-cycle impacts. Point structures were developed to reward the selection of products from manufacturers who have verified improved environmental life-cycle impacts.

aquatherm's green pipe, blue pipe, red pipe and black system products have attained Type III EPD status through independent verification by NSF International. They now can be utilized as a portion of the 20 permanent products engineers must have throughout their LEED-certified buildings. aquatherm's EPD also carries double the weight of the Industry-Wide (Generic) EPD in terms of LEED product value and four times the weight of a self-certified Product-Specific Declaration by a manufacturer. aquatherm has continued its industry leadership position by becoming the first piping manufacturer to have an independently verified, Product-Specific Type III EPD and by supporting building owner to achieve LEED certification.

For further information please see our White Paper: <https://www.aquatherm.de/company/sustainability/?lang=en>

- 1. PP-R
- 2. Other Plastics
- 3. Brass Fittings
- 4. Additives
- 5. Auxiliary Materials
- 6. Energy
- 7. Inbound Transport
- 8. Packaging
- 9. Waste Treatment



COMPLIANCE WITH THE SYSTEM STANDARD

Various national and international independent authorities and institutions confirm aquatherm’s quality standard. You can see our certificates on our website at www.aquatherm.de/products/certificates

AQUATHERM QUALITY MANAGEMENT SYSTEM

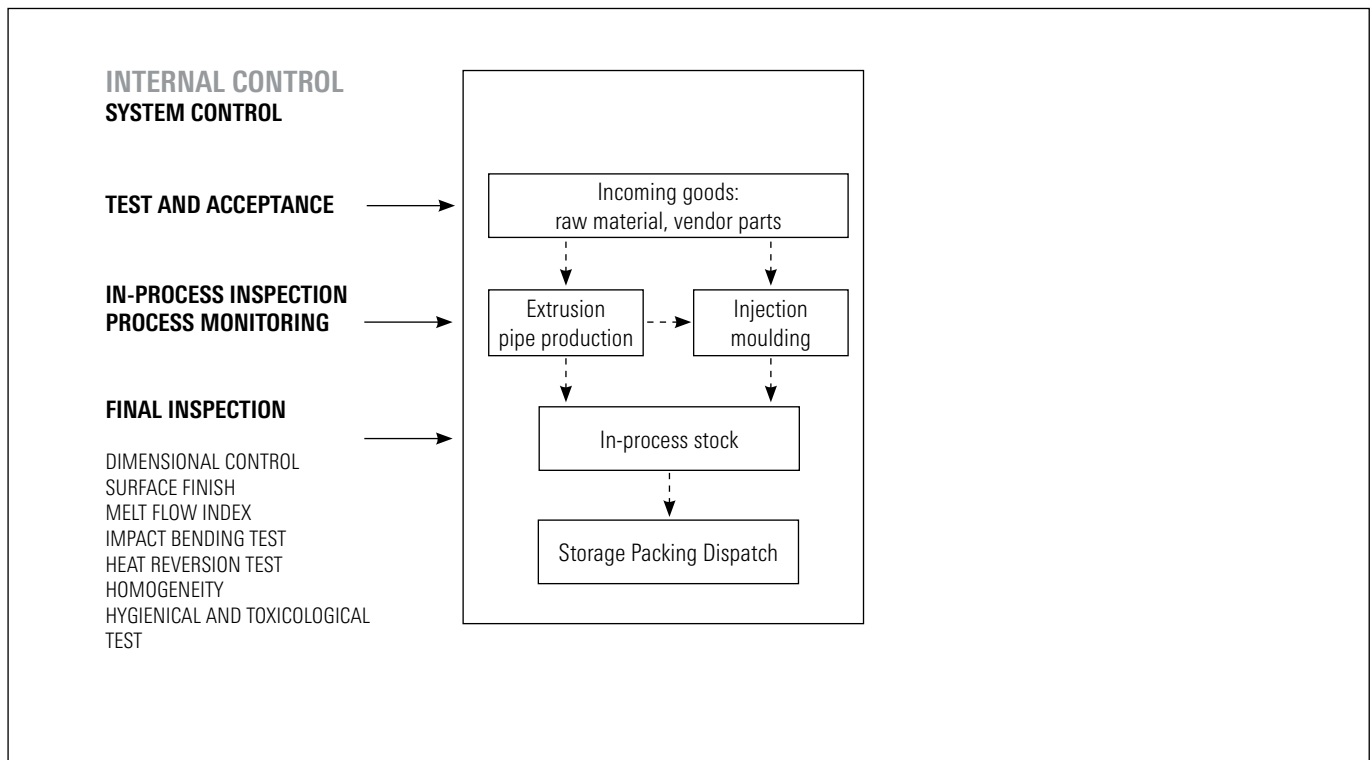

In addition to the permanent internal quality control, an external control is conducted by f.e. SKZ, SAI, TGM, Hygieneinstitut.



SYSTEM CONTROL

The production of a quality controlled pipe system demands the supervision, regulation and control of all work operations. All results and processes have to be documented.

This requires

- test and acceptance of incoming goods**
- process control**
- in-process inspection and test**
- final inspection and test**

The minimum requirements for self-monitoring are derived from the monitoring regulations of the South German Plastic Center (SKZ), DIN guidelines and DVGW-worksheets, compliance with which is checked by neutral test institutes as part of external monitoring.

Conformance to the standards is verified by independent institutes in form of internal audits and laboratory tests.

aquatherm has many years of experience in extrusion and injection moulding and is the market leader and pioneer in the manufacture of polypropylene pipe systems.

This experience is reflected in internal quality standards and laid down procedures, which are taken strongest note of and are documented by the constant quality of our products.

INTERNAL CONTROL

Trained and qualified employees and a modern equipped laboratory ensure that all tests and monitorings requested are carried out in accordance with the quality control policy, which includes

- control of inspection, measuring and test equipment process and production control**
- receiving inspection test**
- in-process inspection**
- final inspection**

All internal quality controls are documented and recorded in accordance with the quality control policy.

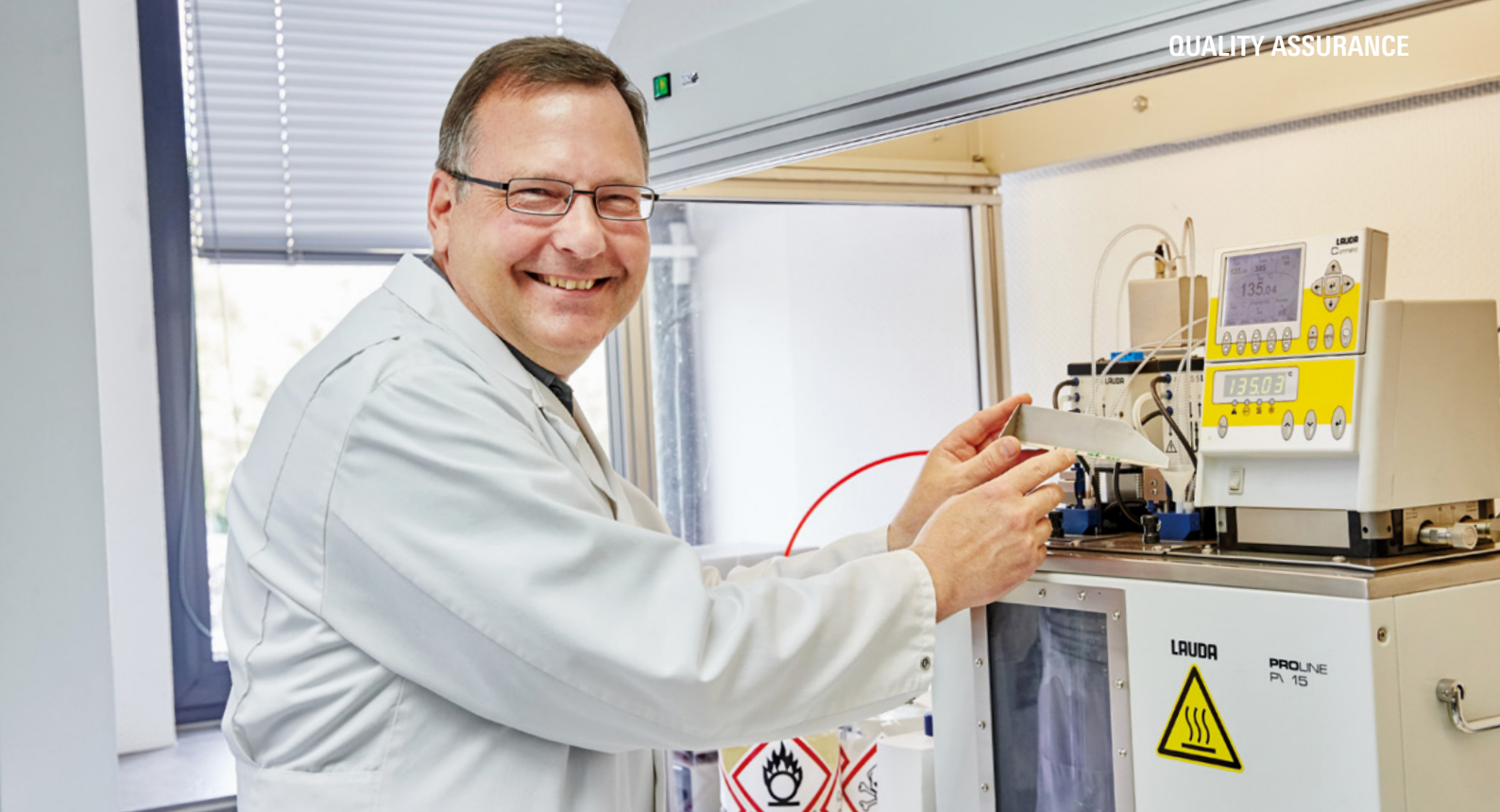

QUALITY ASSURANCE

Test and acceptance of incoming goods

All incoming goods are subject to a test. This ensures that incoming products conform to specified requirements. Goods which have not been tested are not released for production.

In-process inspection and test

The quality plan requires that tests and inspections are carried out before and during production. At the start of production all quality relevant data are checked by the quality assurance department. Preproduction samples are tested by the laboratory technicians for

- Surface finish
- Dimensional accuracy of the test samples
- Data from extrusion and injection moulding machines

and whether they meet the specifications. Only if this is ensured, it will be released for production. The tests are carried out at the beginning of each series production in order to guarantee impeccable quality.

Process control

Ultrasonic measurement and process data recording in the field of extrusion are only two examples of the extensive quality control process.

This equipment enables constant observation and control of production.

Ultrasonics automatically measure and report any deviations in tolerance to the cutting device on the extrusion machine so that the sizing plant automatically isolates a substandard product. This ensures that only perfect quality products are packed and stored.

All data received during production is analyzed in detail.

Final inspection and test

After completion of the products, all final inspections specified in the test plan are conducted. Only if it has been proven that all the required tests are fully documented and the results correspond to the optimum system quality, the products are sent to the finished goods warehouse.

The final inspection and test covers the following test procedures:

- Dimensional control
- Surface finish
- Measurement of the melt flow index
- Impact bending test
- Heat reversion test
- Homogeneity of the material
- Internal pressure test

In addition to the tests mentioned above, daily hygiene tests in accordance with KTW/DVGW guidelines are carried out regularly in the company's own sensory analysis laboratory.

DVGW type examination certificate
DVGW-Baumusterprüfzertifikat

Field of Application products of water supply
Anwendungsbereich Produkte der Wasserversorgung

Owner of Certificate aquatherm GmbH
Zertifizierhalter Biggen 5, D-57439 Attendorn

Distributor aquatherm GmbH
Vertrieber Biggen 5, D-57439 Attendorn

Product Category installation systems with special pipes: drinking water (8801)
Produktart

Product Description drinking water system consisting of plastic pipes (PP-R) type S-KK
Produktbeschreibung

Model aquatherm green pipe SDR6 S (fusiotherm)
Modell

Test Reports laboratory control test: 27516/2, 1/123612 from 02.07.2016
Prüfberichte laboratory control test: 27618/2, 1/122613 from 06.07.2016
KTW testing: K-271607-16-Baust from 13.06.2016
hygienic testing: W-274650-15-Si/Ni from 25.08.2016
KTW testing: K-231614-13-Baust from 02.07.2015
hygienic testing: W-274649-16-Si/Ni from 25.08.2016
laboratory control test: 27605/2, 2/74807 u. Erg. fr

Test Basis DVGW W 534 (01.05.2004)
Prüfungsdagen DVGW W 544 (01.05.2007)
USA KTW (07.10.2008)
DVGW W 270 (01.11.2007)

Date of Expiry / File No. 14.02.2022 / 17-0169-WNV
Ablaufdatum / Aktenzeichen

28.04.2017 (2) A-1/2
Date issued by: [Signature]
Name, Position, Place, Letter of Authorization:
DVGW CERT GmbH is an accredited body to DVGW according to DIN EN ISO/IEC 17065:2013 for certification of products for energy and water supply industry.

08.06.2016 (2) A-1/2
Date issued by: [Signature]
Name, Position, Place, Letter of Authorization:
DVGW CERT GmbH is an accredited body to DVGW according to DIN EN ISO/IEC 17065:2013 for certification of products for energy and water supply industry.

DAKKS
DAKKS
DAKKS
DAKKS

ZERTIFIKAT SKZ Süddeutsches Kunststoff-Zentrum

Verleihungs-Urkunde
Das Süddeutsche Kunststoff-Zentrum verleiht der Firma

Aquatherm GmbH
Kunstst.-Extrusions- u. Spritzgießtechnik
Finnentropfer Straße 82
57439 Attendorn

das Recht zum Führen des SKZ-Prüf- und Überwachungszeichens

SKZ WÜRZBURG

A 175
für nachstehende Kunststoffzeugnisse

Druckrohre aus PP-R 80
Fertigungsgruppe 1 und 2

Mit der Führung des SKZ-Zeichens ist die Verpflichtung verbunden, die Bestimmungen der Fertigungsgruppe 1 und 2 einzuhalten.

Würzburg, den 9. März 1994

[Signature]
Institutsleiter

SKZ WÜRZBURG
VERBODEN VERKEHREND ZU VERWENDEN
NACH DEM VERGEBENDE VERFAHREN

ZERTIFIKAT SKZ Süddeutsches Kunststoff-Zentrum

Verleihungs-Urkunde
Das Süddeutsche Kunststoff-Zentrum verleiht der Firma

Aquatherm GmbH
Kunstst.-Extrusions- u. Spritzgießtechnik
Finnentropfer Straße 82
57439 Attendorn

das Recht zum Führen des SKZ-Prüf- und Überwachungszeichens

SKZ WÜRZBURG

A 314
für nachstehende Kunststoffzeugnisse

Faserverbundrohre aus PP-R 80 / PP-R 80-GF / PP-R 80
Fertigungsgruppe 1 und 2

Mit der Führung des SKZ-Zeichens ist die Verpflichtung verbunden, bei der Herstellung und Prüfung der Erzeugnisse die vorgeschriebenen Bestimmungen einzuhalten.

Würzburg, den 27. Juli 2000

[Signature]
Institutsleiter

SKZ WÜRZBURG
VERBODEN VERKEHREND ZU VERWENDEN
NACH DEM VERGEBENDE VERFAHREN

EXTERNAL CONTROL

External supervision consists of tests of a defined scope and in defined intervals. The respective supervising institutions appoint authorized test organizations to carry out these tests.

The external supervision includes external tests of the products and

- a) internal audit of aquatherm’s quality assurance system and test procedures,
- b) calibration of the test equipment and
- c) hygienic and toxicity tests.

The results of the supervisory visits as well as external tests made on pipe and fitting samples are confirmed to aquatherm in test certificates.

In Germany, the external supervision of the aquatherm green pipe system is carried out by the

- SKZ (Süddeutsches Kunststoffzentrum in Würzburg)
- Institute for Hygiene, Gelsenkirchen (Hygieneinstitut in Gelsenkirchen)

who are authorized by the DVGW (German Institute for Gas and Water) as controlling organization. The external supervision for certificates from abroad is carried out in a similar way.

Storage / packing / dispatch

Upon successful release the products are stored in suitable warehouses.

Internal instructions control the method of packing, storage and dispatch of the products. The warehouse staff are responsible for controlling the stored product.

QUALITY ASSURANCE

The following laws, decrees, guidelines and standards have to be considered on planning and designing aquatherm PP-R pipes for potable water and heating installations:*

Planning:

TrinkwV-2000 Regulation for Potable Water

DIN 2000 Central drinking water supply-Guidelines regarding requirements for potable water, planning, construction, operation and maintenance of plants

EnEV Decree for Energy Saving

DIN EN 806 Standard for Potable Water Installations

ISO 10508 Plastic pipe systems for hot and cold water installation – Guideline for classification and dimensioning

All provided pipe systems correspond to the technical conditions of the application classes according to ISO 10508 for the field of potable water and heating.

aquatherm green pipe for the classes 1, 2 (potable water), aquatherm blue pipe for the classes 4 and 5 (heating). For the application of the classification system (according to ISO 10508) the national regulations and the manufacturer's instructions must be considered.

DIN 4109 Standard for the Elimination of Noise in the Field of Structural Engineering

DIN 18381 Installation of Gas, Water and VOB Part C Sewage Pipes inside Buildings

DIN 16928 Pipe Connections, Fittings, Installation

DVS 2207 Welding of Thermoplastics

DVS 2208 Welding Machines and Devices for Thermoplastics

aquatherm Technical Information

System specific standards:

General quality requirements, dimensions

DIN 8077 Polypropylene (PP) Pipes, Dimensions

DIN 8078 Polypropylene (PP) Pipes, General Quality Requirements

DIN 16962ff Pipe Joint Assemblies and Fittings for Polypropylene Pressure Pipes

DIN EN ISO 15874ff Plastic pipe systems for hot and cold water installation; polypropylene

DVGW-Working sheets

SKZ-Guidelines

DIN EN ISO 9000 ff.

System specific standards: Hygiene

BfR Federal Institute for risk assignment

Health assessment of plastics and non-metallic materials within the framework of the law for foods and commodity goods for potable water applications

DVGW-working sheet W 270

Increase of Microorganism on Materials. Used for Potable Water Applications – Test and Evaluation

BS 6920

“Suitability of non-metallic products for use in contact with water intended for human consumption with regard to their effect on the quality of water.”

Local regulations and codes of practice must be observed. The same applies to the regulations regarding the use of chemicals.

*(Additional regional decrees and recommendations are disregarded.)

FUSION

PART A: TOOLS AND ACCESSOIRES

The professional processing of aquatherm PP-R medium pipes is made by the following tools for the connection of insulated pipes and fittings by socket welding or by butt-welding.

IMPORTANT!

Only use the original aquatherm equipment except devices and tools which are especially approved by aquatherm.

1. **aquatherm** manual welding device (800 W) without welding tools (Art. no. 9800050337) for medium pipes of dimension 16–63 mm
2. **aquatherm** manual welding device (1400W) without welding tools (Art. no. 9800050341) for medium pipes of dimension 50–125 mm
3. **aquatherm** welding tools for manual welding devices

Art. no. 9800050206	16 mm
Art. no. 9800050208	20 mm
Art. no. 9800050210	25 mm
Art. no. 9800050212	32 mm
Art. no. 9800050214	40 mm
Art. no. 9800050216	50 mm
Art. no. 9800050218	63 mm
Art. no. 9800050220	75 mm
Art. no. 9800050222	90 mm
Art. no. 9800050224	110 mm
Art. no. 9800050226	125 mm

4. **aquatherm** welding machine (1400W) incl. welding tools 50–125 mm (Art. no. 9800050148) for medium pipes of dimension 50–125 mm
5. **aquatherm** butt-welding-machines for medium pipes of dimension 160–630 mm
6. **aquatherm** electrical welding jig Art. no. 9800050151 for medium pipes of dimension 63–125 mm



Manual welding device 800W with welding tools 16–63 mm



Manual welding device 1400W with welding tools 50–125 mm

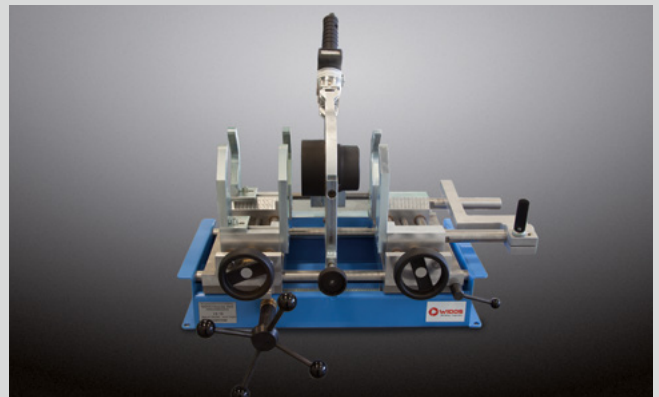

Welding machine

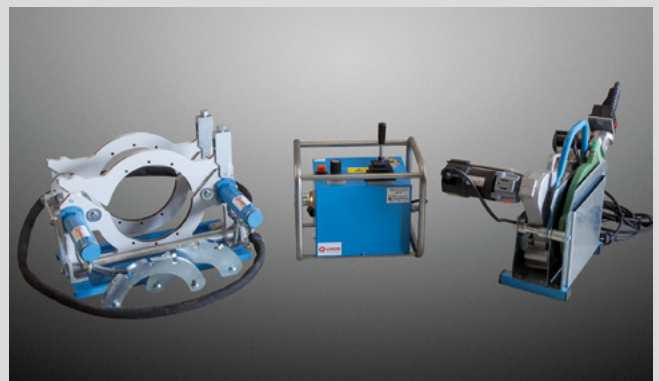

Butt-welding machine two-ring-machine and accessories



Electrical welding jig

PART A: ASSEMBLY OF WELDING TOOLS

1. aquatherm green pipe and aquatherm blue pipe system are processed identically.
2. Assemble and tighten the cold welding tools manually.
3. Before fusing the distribution block, in which two connections are fused simultaneously, the welding tools have to be placed into the respective holes as described in the adjoining table A and drawing B.
4. All welding tools must be free from impurities. Check if they are clean before assembling. If necessary, clean the welding tools with a non fibrous, coarse tissue and with methylated spirit.
5. Place the welding tools on the welding device so that there is full surface contact between the welding tool and the heating plate. Welding tools over $\varnothing 40$ mm must always be fitted to the rear position of the heating plate.

Electric supply:

The power supply must coincide with the data on the type plate of the welding device and must be protected according to the local regulations. To avoid high power loss, the conductor cross-section of the used extension cables must be selected according to the power input of the welding devices.

6. Plug in the welding device. Depending on the ambient temperature it takes 10–30 minutes to heat up the heating plate.

A

Art. no.	Passage	Hole	Branch	Hole
1050025016	$\varnothing 25$ mm	A + E	$\varnothing 20$ mm	A + C
6090020006	$\varnothing 20$ mm	A + B	$\varnothing 16$ mm	A + C

B

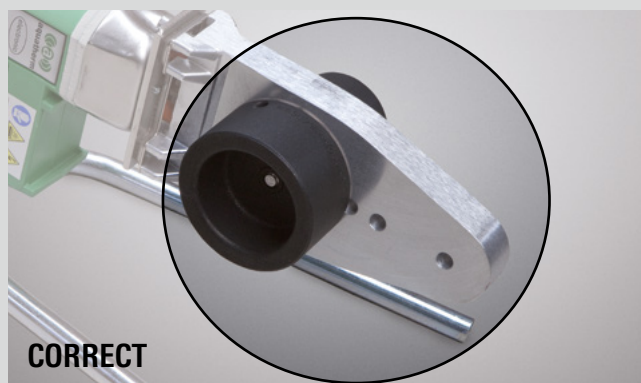
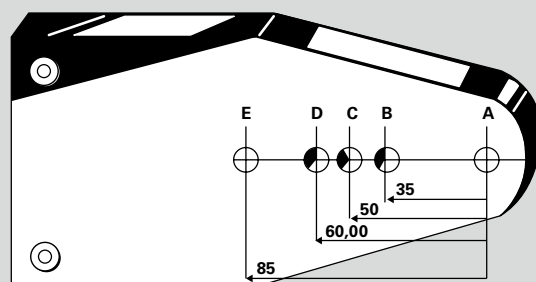

PART A: HEATING UP PHASE / HANDLING

Temperature pilot lamp (yellow)

glows constantly while the heat-up phase and blinks, when the welding temperature is achieved

Operating lamp (green)

glows constantly, as soon as the device is connected with the power supply system

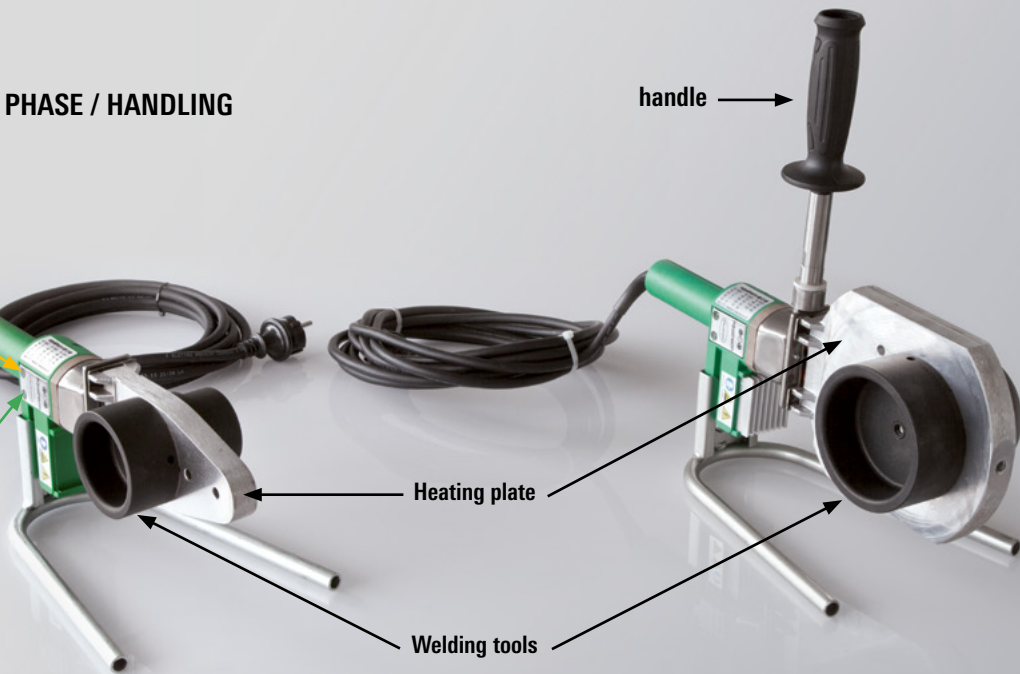

Heat-up phase

7. During the heating up phase tighten the welding tools carefully with the Allan key.

Take care that the tools completely contact the heating plate. Never use pliers or any other unsuitable tools, as this will damage the coating of the welding tools.

8. The temperature of 260 °C is required for the welding of aquatherm PP-R/PP-PR pipes.

According to DVS-Welding Guidelines the temperature of the welding device has to be checked at its tool before starting the welding process.

This can be done with a fast indicating surface thermometer.

ATTENTION:

First welding – earliest 5 minutes after reaching of the welding temperature. DVS 2207, Part 11.

Handling

9. A tool change on a heated device requires another check of the welding temperature at the new tool (after its heating up).

10. If the device has been unplugged, e.g. during longer breaks, the heating up process, has to be restarted (see item 6).

11. After use unplug the welding device and let it cool down. Water must never be used to cool the welding device, as this will destroy the heating resistances.

12. Protect aquatherm welding devices and tools against impurities. Burnt particles may lead to an incorrect fusion. The tools may be cleaned with aquatherm cleaning cloths, Art. no. 9800050193.

Always keep the welding tools dry.

13. After welding, do not lay the device on the Teflon coated tool, but put it down in the provided supporting stand.

14. For a perfect fusion, damaged or dirty welding tools must be replaced, as only impeccable tools guarantee a perfect connection.

15. Never attempt to open or repair a defective device. Return the defective device for repair.

16. Check the operating temperature of aquatherm welding devices regularly by means of suitable measuring instruments.

Guidelines

1. For the correct handling of welding machines the following must be observed: General Regulations for Protection of Labour and Prevention of Accidents and particularly the Regulations of the Employers' Liability Insurance Association of the Chemical Industry regarding Machines for the Processing of Plastics, chapter: „Welding Machines and Welding Equipment“.

2. For the handling of aquatherm welding machines, devices and tools please observe General Regulations DVS 2208 Part 1 of the German Association for Welding Engineering, Registered Society (Deutscher Verband für Schweißtechnik e. V.).

PART B: CHECKING OF DEVICES AND TOOLS

Check, if the aquatherm welding devices and tools comply with the guidelines "Fusion Part A".

The devices and tools used must have reached the required operating temperature of 260 °C for heating element socket welding or 210 °C for butt-welding. This requires according to "Fusion Part A, item 8" a separate test, which is indispensable (DVS-Welding Guidelines):

Suitable measuring instruments have to measure a temperature of up to 350 °C with a high accuracy.

NOTE:

aquatherm recommends the original aquatherm temperature measuring device Art. no. 9800050188.

PART B: PREPARATION FOR THE FUSION

1. Cut the pipe at right angles to the pipe axis. Only use aquatherm pipe cutters or other suitable cutting pliers. Take care that the pipe axis is free from burrs or cutting debris and remove where necessary.

2. Mark the welding depth at the end of the pipe with the enclosed pencil and template.

3. Mark the desired position of the fitting on the pipe and/or fitting. The markings on the fitting and the uninterrupted line on the pipe may be used as a guide.



Measurement of temperature at the aquatherm manual welding device (800W)



Measurement of temperature at the aquatherm welding machine



Measurement of temperature at the aquatherm butt-welding machine



Cutting of the pipe



Marking of the welding depth

PART B: HEATING OF PIPE AND FITTING

4. Push the end of the pipe, without turning, up to the marked welding depth into the welding tool.

pipe dimension mm	welding tool Art. no.
16 – 32	9800050336
16 – 63	9800050337
75 – 125	9800050341 / 9800050148

It is essential to observe the aforementioned heating times.

ATTENTION:

The heating time starts, when pipe and fitting have been pushed to the correct welding depth on the welding tool. Not before!

PART B: SETTING AND ALIGNMENT

5. After the required heating time quickly remove pipe and fitting from the welding tools. Join them immediately and without turning, until the marked welding depth is covered by the PP-bead from the fitting.

ATTENTION:

Do not push the pipe too far into the fitting, as this would reduce the bore and in an extreme case will close up the pipe.

6. The joint elements have to be fixed during the specified assembly time. Use this time to correct the connection. Correction is restricted to the alignment of pipe and fitting. Never turn the elements or align the connection after the processing time.

7. After the required cooling time the fused joint is ready for use.

The result of the fusion of pipe and fitting is a permanent material joining of the system elements. Connection technique with security for a life-time.

The fusion is subject to the following parameters

Pipe external- Ø	Welding depth	Heating time		Welding time	Cooling time
		sec. DVS	sec. AQT*		
20	14,5	5	8	4	2
25	16,0	7	11	4	2
32	18,0	8	12	6	4
40	20,5	12	18	6	4
50	23,5	18	27	6	4
63	27,5	24	36	8	6
75	30,0	30	45	8	8
90	33,0	40	60	8	8
110	37,0	50	75	10	8
125	40,0	60	90	10	8

ATTENTION: sec. AQT* heating times recommended by aquatherm at ambient temperatures below + 5 °C



Heating-up of pipe and fitting



Joining, fixing and...



...aligning

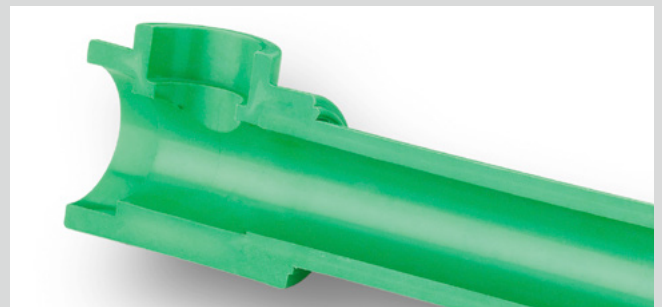

The result: a permanent connection!

Dimension 160–630 mm:

The dimension 160–630 mm are joined by butt-welding.

Detailed information page 58–61.

The General Guidelines for Heated Tool Socket Welding according to DVS 2207 Part 11 are applied hereupon.

PART B: UNIVERSAL PEELING TOOLS

By using the aquatherm universal peeling tools the end pieces of the aquatherm UV (UV-resistant) can be peeled. By the uniform removal of the outer layer of the pipe any extension of the pipe system by electrofusion socket or fitting is possible. The universal peeling tools are available in the sizes \varnothing 20–125 mm (Art. no. 9800050479–9800050488). The peeling process is done either mechanically or manually. For the mechanical processing two attachment plates for pipe sizes \varnothing 20–63 mm (Art. no. 9800050499) and \varnothing 75–125 (Art. no. 9800050500) mm are available. For the mechanical processing of the electrofusion sockets the peeler is extended by an attachment (Art. no. 9800050489–9800050498). The power drill should have a high torque.

1. INSTRUCTIONS FOR THE MECHANICAL PEELING PROCESS

- 1.1. The attachment plate is clamped with the hexagon bolt in the power drill.
- 1.2. The peeler is fixed with its screws in the slot matching the diameter of the attachment plate and rotated clockwise so that the peeler adheres to the attachment plate.
- 1.3. The peeling tool clamped on the chuck is set by the lead to the end of the pipe.
- 1.4. The peeling process starts with rotation of the peeling tool upon slight force in axial direction. The peeling operation is completed when the attachment plate strikes against the pipe end.
- 1.5. The pipe now can be welded by socket welding method.

2. INSTRUCTIONS FOR THE MECHANICAL PEELING PROCESS FOR ELECTROFUSION SOCKETS

- 2.1. The extension is centered with the peeler through the superimposed chamfer fit and fastened with three Allen screws.
- 2.2. The attachment plate is clamped with the hexagon bolt in the power drill and connected with the peeling tool (see photo 1.2.).
- 2.3. The peeling process starts with rotation of the peeling tool upon slight force in axial direction. The peeling operation is completed when the carrier plate strikes against the pipe end.
- 2.4. The peeling tool is withdrawn from the pipe and the E-socket welding process can start.

3. PEELING INSTRUCTIONS FOR MANUAL PEELING

- 3.1. For the manual peeling two handles are mounted at the peeling tool.
- 3.2. The peeling tool is pushed onto the untreated pipe up to the stop.
- 3.3. The peeling tool is turned clockwise as long as the marked peeling depth (see table on the next page) is reached.
- 3.4. If the specified/marked peeling depth (see table) is reached, the peeling tool is removed and the socket welding process can start. If the electric socket can be used as a sliding sleeve, the peeling depth for the electric socket welding (see table) must be doubled.



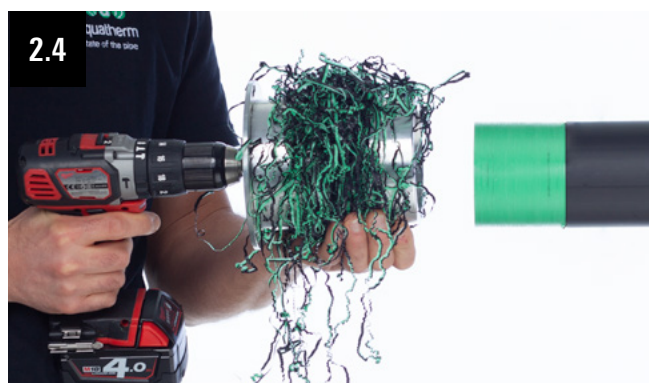
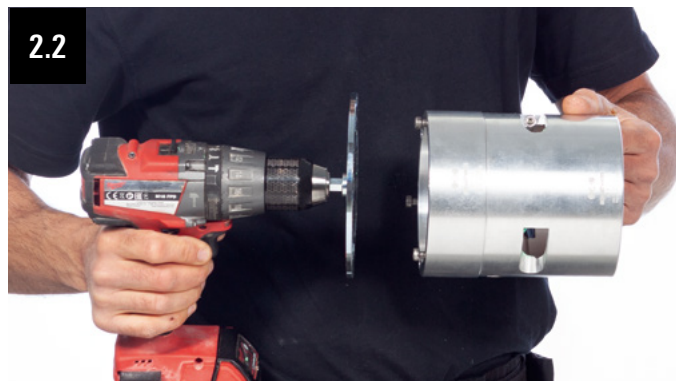

**TABLE OF PEELING DEPTH:
SOCKET AND ELECTRIC SOCKET WELDING**

Diameter	Peeling depth Socket welding	Peeling depth Electric socket welding
ø 20	16 mm	39 mm
ø 25	20 mm	43 mm
ø 32	22 mm	45 mm
ø 40	25 mm	50 mm
ø 50	28 mm	56 mm



Diameter	Peeling depth Socket welding	Peeling depth Electric socket welding
ø 63	32 mm	65 mm
ø 75	34 mm	69 mm
ø 90	37 mm	77 mm
ø 110	42 mm	85 mm
ø 125	44 mm	90 mm

PART C: WELD-IN SADDLES

aquatherm weld-in saddles are available for pipe outer diameter of 40–630 mm.

Weld-in saddles are used for

- Branch connections in existing installations
- The substitution of a reduction-tee
- Branch connections in risers
- Sensor wells, etc.

The maximum sensor well diameter is specified in the table on page 47.

1. Before starting the welding process, check whether the aquatherm welding devices and tools comply with the requirements of "Fusion Part A".
2. The first step is to drill through the pipe wall at the intended outlet point by using the aquatherm drill (Art. no. 9800050940–980005094850).

3. IMPORTANT!

Only the UV layer of the aquatherm green pipe UV must be removed with the mentioned aquatherm special peeling drills mentioned in the table beside.

For this the special peeling drill is inserted into the bore hole and swayed 2–3 times with light pressure and low rotating speed between the pipe walls until the UV layer is completely peeled off.

Remove burrs, debris and other dirt with a chamfering tool or the aquatherm cleaning wipes. Do not touch the peeled surface any more and protect it from new pollution.

4. The welding device / saddle welding tool must have reached the required operating temperature of 260 °C (check with reference to "Fusion Part B, item 2").
5. The welding surfaces have to be clean and dry.
6. Insert the heating tool on the concave side of the weld-in saddle tool into the hole drilled in the pipe wall until the tool is completely in contact with the outer wall of the pipe. Next the weld-in saddle tool is inserted into the heating sleeve until the saddle surface is up against the convex side of the welding tool. The heating time of the elements is generally 30 seconds.
7. After the welding tool has been removed, the weld-in saddle tool is immediately inserted into the heated, drilled hole. Then the weld-in saddle should be pressed on the pipe for about 15 seconds. After being allowed to cool for 10 minutes the connection can be exposed to its full loading. The appropriate branch pipe is fitted into the sleeve on the aquatherm weld-in saddle using conventional fusion technology.

By fusing the weld-in saddle with the pipe outer surface and the pipe inner wall the connection reaches highest stability.

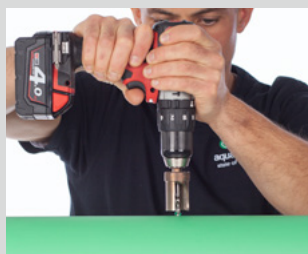

Drilling through the pipe wall

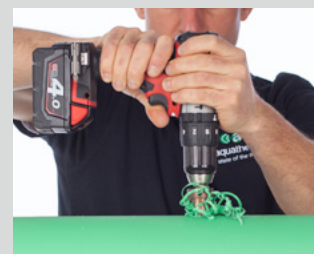

Removal of the UV layer in case of the aquatherm UV-pipe



aquatherm saddle peeling tools for **aquatherm green pipe** UV-pipes
ø 50–125 mm

Art. no.	Dimension
9800050921	for weld-in saddles ø 20 & 25 mm
9800050922	for weld-in saddles ø 32 mm
9800050924	for weld-in saddles ø 40 mm
9800050926	for weld-in saddles ø 50 mm
9800050928	for weld-in saddles ø 63 mm

aquatherm saddle peeling tools for **aquatherm green pipe** UV-pipes
ø 160–250 mm

Art. no.	Dimension
9800050421	for weld-in saddles ø 20 & 25 mm
9800050422	for weld-in saddles ø 32 mm
9800050424	for weld-in saddles ø 40 mm
9800050426	for weld-in saddles ø 50 mm
9800050428	for weld-in saddles ø 63 mm

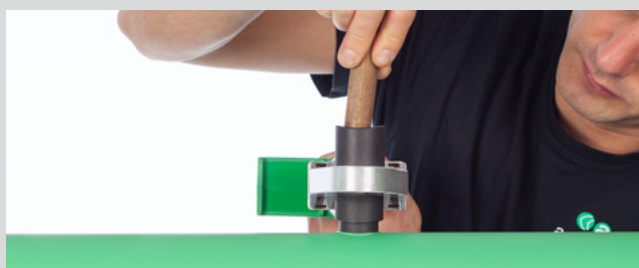

The welding tool is inserted into the pipe wall ...



...heating-up of the elements

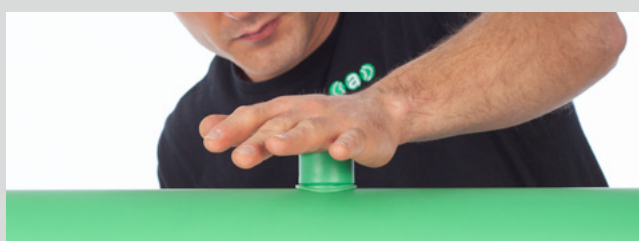

joining

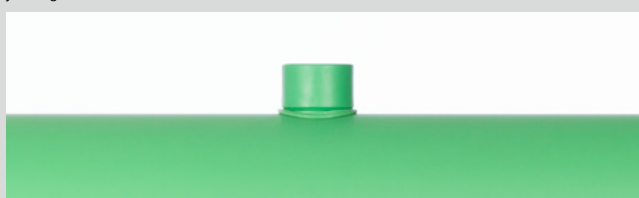

Ready!

PART C: WELD-IN SADDLES

Art. no.	Dimension	D	d	l	Drill	Special peeling drill ¹	Special peeling drill ¹
		mm	mm	mm	Art. no.	Art. no.	Art. no.
1030040001	40/20 mm	40	25	27.0	9800050940	9800050921	9800050614
1030040002	40/25 mm	40	25	28.0	9800050940	9800050921	9800050614
1030050902	50/20 mm	50	20	27.0	9800050940	9800050921	9800050616
1030050903	50/25 mm	50	25	28.0	9800050940	9800050921	9800050616
1030063904	63/20 mm	63	20	27.0	9800050940/9800050941	9800050921	9800050619
1030063905	63/25 mm	63	25	28.0	9800050940/9800050941	9800050921	9800050619
1030063906	63/32 mm	63	32	30.0	980009800050942	9800050922	9800050620
1030075907	75/20 mm	75	20	27.0	9800050940/9800050941	9800050921	9800050623
1030075908	75/25 mm	75	25	28.0	9800050940/9800050941	9800050921	9800050623
1030075909	75/32 mm	75	32	30.0	9800050942	9800050922	9800050624
1030075910	75/40 mm	75	40	34.0	9800050944	9800050924	9800050625
1030090911	90/20 mm	90	20	27.0	9800050940/9800050941	9800050921	9800050627
1030090912	90/25 mm	90	25	28.0	9800050940/9800050941	9800050921	9800050627
1030090913	90/32 mm	90	32	30.0	9800050942	9800050922	9800050628
1030090914	90/40 mm	90	40	34.0	9800050944	9800050924	9800050629
1030110915	110/20 mm	110	20	27.0	9800050940/9800050941	9800050921	9800050631
1030110916	110/25 mm	110	25	28.0	9800050940/9800050941	9800050921	9800050631
1030110917	110/32 mm	110	32	30.0	9800050942	9800050922	9800050632
1030110918	110/40 mm	110	40	34.0	9800050944	9800050924	9800050634
1030110919	110/50 mm	110	50	34.0	9800050946	9800050926	9800050635
1030125920	125/20 mm	125	20	27.0	9800050940/9800050941	9800050921	9800050636
1030125921	125/25 mm	125	25	28.0	9800050940/9800050941	9800050921	9800050636
1030125922	125/32 mm	125	32	30.0	9800050942	9800050922	9800050638
1030125923	125/40 mm	125	40	34.0	9800050944	9800050924	9800050640
1030125924	125/50 mm	125	50	34.0	9800050946	9800050926	9800050642
1030125925	125/63 mm	125	63	38.0	9800050948	9800050928	9800050644
1030160926	160/20 mm	160	20	27.5	9800050940/9800050941	9800050421	9800050648
1030160927	160/25 mm	160	25	28.5	9800050940/9800050941	9800050421	9800050648
1030160928	160/32 mm	160	32	30.0	9800050942	9800050422	9800050650
1030160929	160/40 mm	160	40	34.0	9800050944	9800050424	9800050652
1030160930	160/50 mm	160	50	34.0	9800050946	9800050426	9800050654
1030160931	160/63 mm	160	63	38.0	9800050948	9800050428	9800050656
1030160932	160/75 mm	160	75	42.0	9800050987**	-	9800050657
1030160933	160/90 mm	160	90	45.0	9800050988**	-	9800050658
1030250934	200-250/20 mm	200-250	20	27.5	9800050941	9800050421	9800050660 / 9800050672
1030250935	200-250/25 mm	200-250	25	28.5	9800050941	9800050421	9800050660 / 9800050672
1030250936	200-250/32 mm	200-250	32	30	9800050942	9800050422	9800050662 / 9800050674
1030200937	200/40 mm	200	40	34	9800050944	9800050424	9800050664
1030200938	200/50 mm	200	50	34	9800050946	9800050426	9800050666
1030200939	200/63 mm	200	63	37.5	9800050948	9800050428	9800050668
1030200940	200/75 mm	200	75	42.0	9800050987**	-	9800050667
1030200941	200/90 mm	200	90	42.0	9800050988**	-	9800050669
1030200942	200/110 mm	200	110	49.0	9800050989**	-	9800050670
1030200943	200/125 mm	200	125	55.0	9800050990**	-	9800050671
1030250944	250/40 mm	250	40	34	9800050944	9800050424	9800050672
1030250945	250/50 mm	250	50	34	9800050946	9800050426	9800050678
1030250946	250/63 mm	250	63	37.5	9800050948	9800050428	9800050680
1030250947	250/75 mm	250	75	42.0	9800050987**	-	9800050682
1030250948	250/90 mm	250	90	45.0	9800050988**	-	9800050684
1030250949	250/110 mm	250	110	49.0	9800050989**	-	9800050686
1030250950	250/125 mm	250	125	55.0	9800050990**	-	9800050688
1030315052	315/63 mm	315	63	37.5	9800050948	-	9800050690
1030315053	315/75 mm	315	75	42.0	9800050987**	-	9800050692
1030315054	315/90 mm	315	90	45.0	9800050988**	-	9800050694
1030315055	315/110 mm	315	110	49.0	9800050989**	-	9800050696
1030315056	315/125 mm	315	125	55.0	9800050990**	-	9800050698
1030355058	355/90 mm	355	90	45.0	9800050988**	-	9800050716
1030355059	355/110 mm	355	110	49.0	9800050989**	-	9800050718
1030355060	355/125 mm	355	125	55.0	9800050990**	-	9800050720
1033315073	315/160 mm	315	160	80.0	9800050991**	-	9800050699
1033355074	355/160 mm	355	160	80.0	9800050991**	-	9800050722
1034315057	315/160 mm	315	160	80.0	9800050991**	-	9800050699
1034355061	355/160 mm	355	160	-	9800050991**	-	9800050722
1030500062	400-500/75 mm	400-500	75	-	9800050987**	-	9800050728
1030450063	400-450/110 mm	400-500	110	-	9800050989**	-	9800050736
1030400064	400/125 mm	400	125	-	9800050990**	-	9800050742
1030500065	400-500/90 m	400-500	90	-	9800050988**	-	9800050732
1030500066	450-500/125 m	400-500	125	-	9800050990**	-	9800050744
1030630067	400-630/63 mm	400	63	-	9800050948	-	9800050726
1030560068	500-560/110 mm	500-560	110	-	9800050989**	-	9800050738
1030630069	560-630/75 mm	560-630	75	-	9800050987**	-	9800050730
1030630070	560-630/90 mm	560-630	90	-	9800050988**	-	9800050734
1030630071	560-630/125 mm	560-630	125	-	9800050990**	-	9800050746
1030630072	630/110 mm	630	110	-	9800050989**	-	9800050740

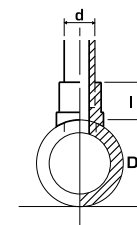

1) only for aquatherm blue pipe OT fibre composite pipes, Art. no. 2112020006-2114250030
 ** only in conjunction with the aquatherm hole saw system

PART C: WELD-IN SADDLES

Art. no.	Dimension	D	d	l	Sensorwells	Drill	Special peeling drill ¹	Tool
		mm	mm	mm	Art. no.	Art. no.	Art. no.	Art. no.
1030040100	40/25 x 1/2" f	40	1/2"	39,0	14	9800050940	9800050921	9800050614
1030050106	50/25 x 1/2" f	50	1/2"	39,0	14	9800050940	9800050921	9800050616
1030063112	63/25 x 1/2" f	63	1/2"	39,0	14	9800050940/9800050941	9800050921	9800050619
1030075118	75/25 x 1/2" f	75	1/2"	39,0	14	9800050940/9800050941	9800050921	9800050623
1030090126	90/25 x 1/2" f	90	1/2"	39,0	14	9800050940/9800050941	9800050921	9800050627
1030110134	110/25 x 1/2" f	110	1/2"	39,0	14	9800050940/9800050941	9800050921	9800050631
1030125142	125/25 x 1/2" f	125	1/2"	39,0	14	9800050940/9800050941	9800050921	9800050636
1030160150	160/25 x 1/2" f	160	1/2"	39,0	14	9800050940/9800050941	9800050921	9800050648
1030250158	200–250/25 mm x 1/2" f	200–250	1/2"	39,0	14	9800050941	9800050921	9800050660/9800050672
1030040101	40/25 x 3/4" f	40	3/4"	39,0	16	9800050940	9800050921	9800050614
1030050107	50/25 x 3/4" f	50	3/4"	39,0	16	9800050940	9800050921	9800050616
1030063113	63/25 x 3/4" f	63	3/4"	39,0	16	9800050940/9800050941	9800050921	9800050619
1030075119	75/25 x 3/4" f	75	3/4"	39,0	16	9800050940/9800050941	9800050921	9800050623
1030090127	90/25 x 3/4" f	90	3/4"	39,0	16	9800050940/9800050941	9800050921	9800050627
1030110135	110/25 x 3/4" f	110	3/4"	39,0	16	9800050940/9800050941	9800050921	9800050631
1030125143	125/25 x 3/4" f	125	3/4"	39,0	16	9800050940/9800050941	9800050921	9800050636
1030160151	160/25 x 3/4" f	160	3/4"	39,0	16	9800050940/9800050941	9800050921	9800050648
1030250159	200–250/25 mm x 3/4" f	200–250	3/4"	39,0	16	9800050941	9800050921	9800050660/9800050672
1030075120	75/32 x 1" f	75	1"	43,0	20	9800050942	9800050922	9800050624
1030090128	90/32 x 1" f	90	1"	43,0	20	9800050942	9800050922	9800050628
1030110136	110/32 x 1" f	110	1"	43,0	20	9800050942	9800050922	9800050632
1030125144	125/32 x 1" f	125	1"	43,0	20	9800050942	9800050922	9800050638
1030160152	160/32 x 1" f	160	1"	43,0	20	9800050942	9800050922	9800050650
1030250160	200–250/32 mm x 1" f	200–250	1"	43,0	20	9800050942	9800050922	9800050662/9800050674

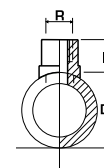

Art. no.	Dimension	D	d	l	Drill	Special peeling drill ¹	Tool
		mm	mm	mm	Art. no.	Art. no.	Art. no.
1030040102	40/25 x 1/2" m	40	1/2"	55,0	9800050940	9800050921	9800050614
1030050108	50/25 x 1/2" m	50	1/2"	55,0	9800050940	9800050921	9800050616
1030063114	63/25 x 1/2" m	63	1/2"	55,0	9800050940/9800050941	9800050921	9800050619
1030075121	75/25 x 1/2" m	75	1/2"	55,0	9800050940/9800050941	9800050921	9800050623
1030090129	90/25 x 1/2" m	90	1/2"	55,0	9800050940/9800050941	9800050921	9800050627
1030110137	110/25 x 1/2" m	110	1/2"	55,0	9800050940/9800050941	9800050921	9800050631
1030125145	125/25 x 1/2" m	125	1/2"	55,0	9800050940/9800050941	9800050921	9800050636
1030160153	160/25 x 1/2" m	160	1/2"	55,0	9800050940/9800050941	9800050921	9800050648
1030040103	40/25 x 3/4" m	40	3/4"	56,0	9800050940	9800050921	9800050614
1030050109	50/25 x 3/4" m	50	3/4"	56,0	9800050940	9800050921	9800050616
1030063115	63/25 x 3/4" m	63	3/4"	56,0	9800050940/9800050941	9800050921	9800050619
1030075122	75/25 x 3/4" m	75	3/4"	56,0	9800050940/9800050941	9800050921	9800050623
1030090130	90/25 x 3/4" m	90	3/4"	56,0	9800050940/9800050941	9800050921	9800050627
1030110138	110/25 x 3/4" m	110	3/4"	56,0	9800050940/9800050941	9800050921	9800050631
1030125146	125/25 x 3/4" m	125	3/4"	56,0	9800050940/9800050941	9800050921	9800050636
1030160154	160/25 x 3/4" m	160	3/4"	56,0	9800050940/9800050941	9800050921	9800050648

¹ only for aquatherm blue pipe OT fibre composite pipes, Art. no. 2112020006–2114250030

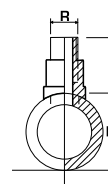

PART C: WELD-ON SADDLE

Drilling of aquatherm PP pipes with the hot tapping tool Art. no. 9800050890 under pressure.

The aquatherm weld-on saddle set (consisting of ball valve, pipe and saddle in the dimensions 40 mm and 63 mm) is used for the additional installation of branch connections.

The PP-R pipes aquatherm green pipe and aquatherm blue pipe with the pipe structure S, MF and MF UV in the dimensions 75–630 mm can be drilled under pressure.

SAFETY INSTRUCTION:

The medium pressure (e.g. water) in the main pipe of 6 bar and the medium temperature of max. 60 °C must not be exceeded.

1. Preparation and fusion

After removal of the oxide layer on the main pipe and the cleaning of the welding surfaces, the welding device is placed with the weld-on saddle tool on the surfaces to be welded. Under gentle pressure and a warm-up time of 90 sec. an even bead must be there on the welding surfaces. After a warm-up time, the component is placed quickly on the main pipe. The component is fixed and aligned on the main pipe for max. 15 seconds. The connection is fully able to work under pressure after a cooling time of 15 minutes.

2. Assembly of the hot tapping tool

The hot tapping tool is screwed onto the component with the retracted drill rod, which is secured by the clamping claw. The screw connection on the ball valve is tightened by hand. After the ball valve has been opened, the welded component in conjunction with the hot tapping tool is tested for leaks with water or air.

3. Drilling process

When the clamping claw is loosened, the drill rod is pushed until the drilling tool contacts the pipe. Depending on the branch size, the appropriate feed rate must be set. The drilling is carried out by actuating the ratchet handle and simultaneously by giving a manually sensitive feed on the feed handles. After completion of the drilling and the release of the clamping claw, the drill rod is led back to the stop by hand. Caution: The drill rod can rebound by the pressure in the pipe. The ball valve is then closed and the hot tapping device is relieved of pressure.

4. Disassembly

Detach the hot tapping device by holding the screw on the ball valve and remove it from the component. Pull the drill rod out of the hot tapping device and screw the drilling tool from the drill rod using a suitable wrench or armature tongs.



Hot tapping device Art.no. 9800050890



1. Welding-on of weld-on saddle set onto the main pipe



2. Assembly of the hot tapping tool onto the component



3. Start of the drilling process



4. Removal of the drilling residues out of the drilling tool

PART D: WELDING JIG (HITCH)

Note

The following description of the electric welding jig applies to the type of the year 2013.

Operation and fusion

With the help of the electric welding jig, all aquatherm polypropylene pipes and fittings in dimensions from 63 to 125 mm are in a very simple manner without any effort welded together.

The welding jig also simplifies the welding of pipes and fittings under ceilings, in narrow shafts and other hard-to-reach places.

Preparation for the fusion

Mark the welding depth with the included green marking template on the pipe end (Fig. 1). In addition, the clamping depth is measured 2 cm from the welding depth marking and marked again (Fig. 2 + 3).



PART D: WELDING JIG (HITCH)

Preparation for the fusion

The welding jig is now placed on the fitting or pipe to be welded with the clamping jaws (Fig. 4).

The two arrows of the jaws and the machine must be flush with each other. The jaws are to be fixed with the help of the clamping device (Fig. 5).

Align the pipe so that the rear marking is flush with the inner edge of the clamping jaw. The front marking identifies the welding depth (Fig. 6).

Lock pipe and fitting by using the front adjusting screws (Fig. 7).

Never clamp so tight that deformations appear. Additionally, with the fitting support, all fittings are supported. The support is mounted on the clamping jaw for fittings (Fig. 8).

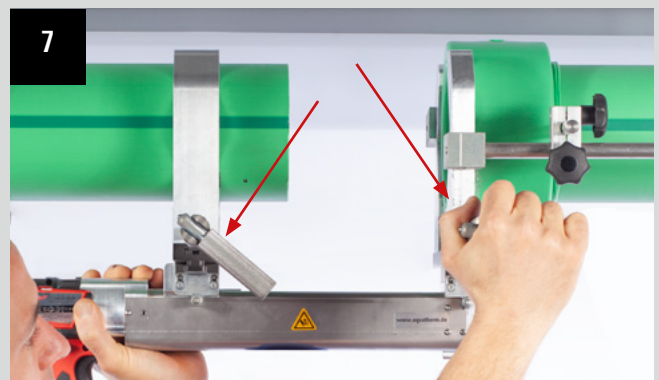
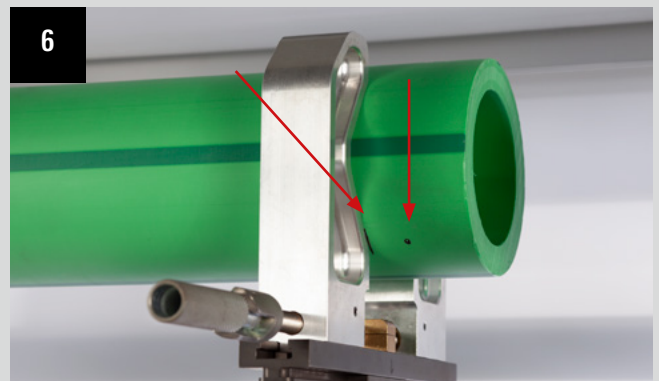
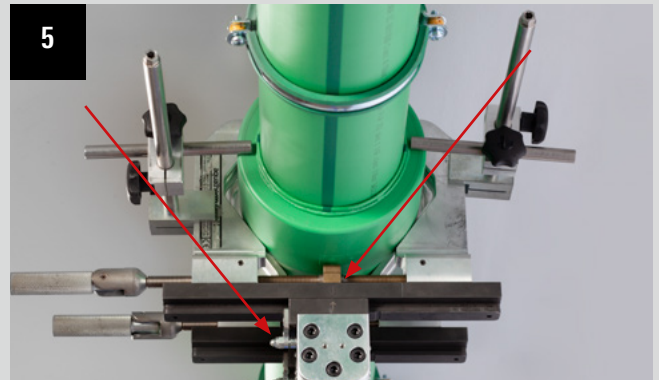
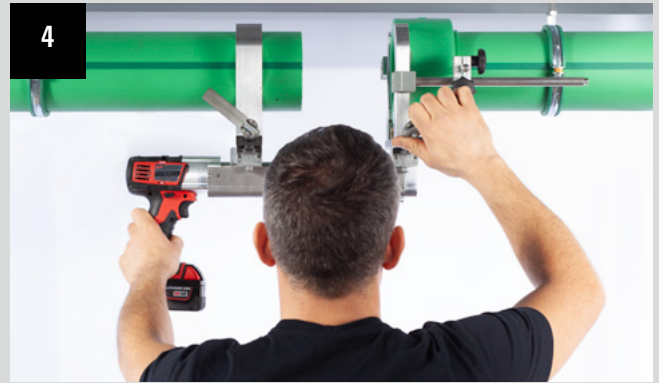

PART D: WELDING JIG (HITCH)

Fusion

Hold the welding device between pipe and fitting and ride machine carriage in batches together (pay attention to the welding depth).

Basically the jaws must be released after the insertion of pipe and fitting in the welding tool by a short return of the machine (3–7 mm)! The jaws must always be parallel to each other (Fig. 9 +10).

After finishing of the warm-up drive the machine carriage apart and remove the welding device (Fig. 11).

Ride the jaws together again and release the clamping jaws again by a short return of the machine (3–7 mm) (Fig. 12).

CAUTION:

Jaws may be released only after the specified cooling time!

Pipe and fitting are now joined by fusion to a material unit (Fig. 13).

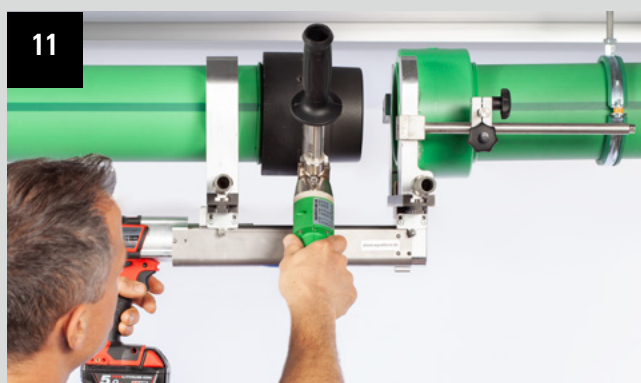

The fusion is subject to the following parameters

Pipe external- Ø	Welding depth	Heating time		Welding time	Cooling time
		sec. DVS	sec. AQT*		
63	27,5	24	36	8	6
75	30,0	30	45	8	8
90	33,0	40	60	8	8
110	37,0	50	75	10	8
125	40,0	60	90	10	8

ATTENTION: sec. AQT* heating times recommended by aquatherm at ambient temperatures below + 5 °C

The General Guidelines for Heated Socket Welding according to DVS 2207, Part 11 are applied hereupon.

PART E: AQUATHERM WELDING MACHINE

for stationary processing 50–125 mm

precise pre-assembly and facilitation by hand creek

clamping jaws 50–125 mm, tools 50–125 mm

Scope of supply:

wooden transport box, slide with sub-construction, clamping jaws 50–125 mm, welding tools 50–125 mm, stay with rolls

For welding of aquatherm green pipe/aquatherm blue pipe a welding temperature of 260 °C at the welding tools is necessary (see page 41).

Instructions for use can be taken from the attached operation manual.



The fusion is subject to the following parameters

Pipe external- Ø	Welding depth	Heating time		Welding time	Cooling time
		sec. DVS	sec. AQT*		
mm	mm	sec.	min.	sec.	min.
50	23,5	18	27	6	4
63	27,5	24	36	8	6
75	30,0	30	45	8	8
90	33,0	40	60	8	8
110	37,0	50	75	10	8
125	40,0	60	90	10	8

ATTENTION: sec. AQT* heating times recommended by aquatherm at ambient temperatures below + 5 °C

The General Guidelines for Heated Socket Welding according to DVS 2207, Part 11 are applied hereupon.

Dimension 160–630 mm:

The dimension 160–630 mm are joined by butt-welding.

Detailed information on page 58–61.

PART E: WELDING MACHINE PRISMA-LIGHT

Welding machine prisma-light with heating plate without tools

Clamping fixture for fixing the prisma-light e. g. at the work bench

1. Check machine: temperature lamp blinks after reaching the welding temperature (260 °C), adjust clamping jaws 63–125 mm coarsely. Mark welding depth with the template at the pipe.
2. Fix the fitting against the clamping jaws.
3. Place the pipe loose in the opposite clamping jaws.
4. Position the welding device centrally to the pipe-fitting axis and remove it.
5. Lock the front calibration knob and drive up the slide as far as it will go.
6. In this position push the pipe against the fitting and fix it with the clamping jaws.
7. Regulate the welding time according to the table on page 52, place the welding device and push the fitting and pipe slowly as far as it will go up to the marking.
8. The heating time starts when pipe and fitting are completely pushed on the tool. When heating time is complete, return the slide, remove the heating device quickly and join the pipe and fitting.
9. Consider cooling times from the table on page 52.

More detailed information can be found in the enclosed operating manuals.

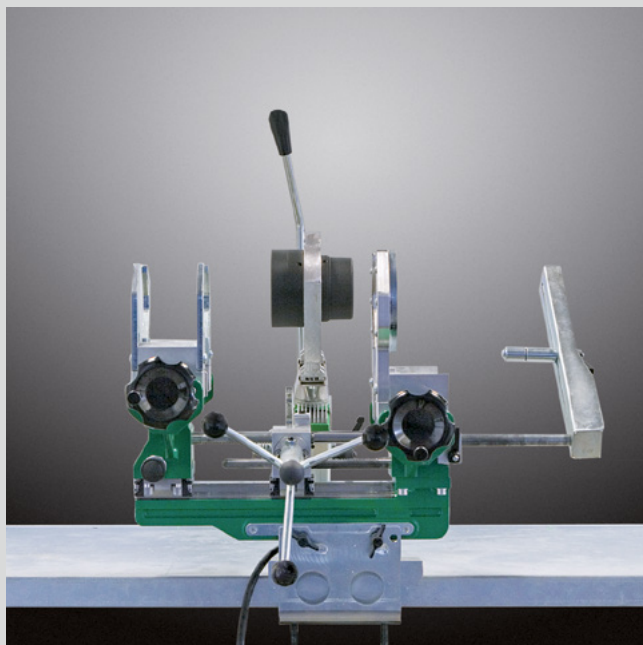

PART F: ELECTROFUSION DEVICE

Fusion

The aquatherm electrofusion device was specially developed for electrofusion sockets from Ø 20–250 mm.

The fusion of 160–250 mm aquatherm blue pipe MF OT with the electrofusion socket is not possible.

Technical information:

supply voltage: 230 V (nominal voltage)
 nominal capacity: 2.800 VA, 80 % ED
 rated frequency: 50–60 Hz
 protection class: IP 54

1. General and inspection

Cleanliness is – besides correct workmanship – the most important precondition for a correct fusion. For keeping the sockets clean do not unwrap them before processing.

The pipe surface must also be clean and undamaged. Deformed pipe ends must be cut off.

All parts of the system to be fused as well the temperature sensors shall have the same temperature (e.g. sun radiation or unadapted storing may cause differences in temperature!) within the acceptable range of temperature (e.g. +5 °C to 40 °C according to DVS 2207).

2. Preparation

Follow carefully the order of working steps!

Preparation is one of the most important steps of the electrofusion process!

2.1 Cut the ends of the pipes rectangularly and deburr them thoroughly

2.2 Clean and dry the ends of the pipes at the necessary length

2.3 Mark the depth of aquatherm electrofusion socket on the end of the pipe



aquatherm electrofusion device Ø 20–250 mm



aquatherm electrofusion socket



aquatherm peeling tool for dimensions from 110–250 mm

Welding depth up to 250 mm

Ø	20	25	32	40	50	63	75	90	110	125	160	200	250
ET	35,0	39,0	40,0	46,0	51,0	59,0	65,0	72,5	80,0	86,0	93,0	105,0	125,0

PART F: ELECTROFUSION DEVICE

Fusion

Peel the surface of both pipes up to the marks thoroughly with a peeling tool (use the aquatherm peeling tool with the respective pipe diameter).

IMPORTANT!

Before the fusion peel off the oxygen barrier layer of the aquatherm blue pipe OT and the UV-layer of the fibre composite pipe UV completely to the stop by using the universal peeling tools considering the pipe diameter.

By turning the adjusting screw clockwise to the stop, the peeling tools can be adjusted into small depths (sockets), by turning them counter clockwise up to the stop they can be adjusted into big peeling depth (electrofusion sockets).

Clean again thoroughly

Without complete peeling of the fusion surface a homogeneous and tight welding connection is not assured. Damages of the surface like axial grooves and scratches are not accepted in the fusion zone. Never touch peeled surfaces and protect them against dirt and grease. Start the fusion process within 30 mins after peeling.

3. Assembling the electrofusion sockets

Avoid soiling and fix all parts securely!

- 3.1. Open the protective wrapping of the aquatherm electrofusion sockets (cut with knife along the edge of the bore), leaving the rest of the foil intact. Clean the inside of the fitting carefully with aquatherm cleaning wipes. The socket must be dry after cleaning. Assemble the fitting within 30 mins after opening of the protective foil.
- 3.2 Push the aquatherm electrofusion sockets on the clean and dry end of the pipe (up to the marked depth). Use pressing clamps if necessary.

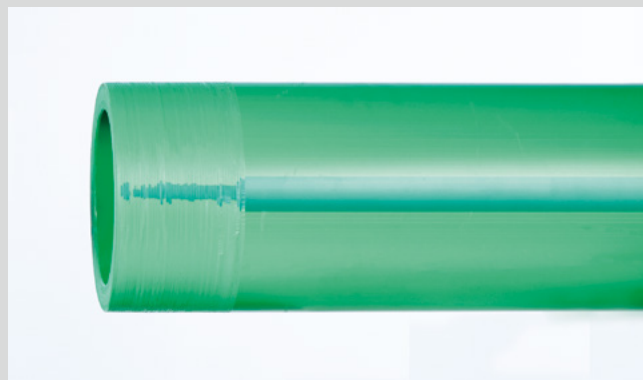

Cut the pipes to be welded, peel, clean and dry thoroughly with a lint-free cloth or paper



Clean the electrofusion socket's inner surface with a lint-free cloth or paper. Remove moisture that may occur **immediately before the welding process** again.



Push the electrofusion socket onto the pipe end



PART F: ELECTROFUSION DEVICE

Remove the protective foil completely and push the other prepared pipe end into the aquatherm electrofusion socket as far as it will go tighten in the fixation.

Leave the pipes, free from bending stress or own weight, within the aquatherm electrofusion socket. The socket is movable at both pipe ends after assembling. The air gap has to be even around the circumference. Pipes and fittings must be welded stress-free.

4. Fusion process

- 4.1 Position the fitting with even air gap around the circumference.
- 4.2 Regulate fusion equipment for the right fusion parameter.
- 4.3 Compare the indications of the fusion equipment with the parameters of the label.
- 4.4 Start and watch the fusion process.

Do not move or stress pipe and fitting during the whole fusion process and cooling time.

5. Cooling time and pressure test

A fused pipe-joint shall not be moved (no release of the fixation) or stressed before complete cooling.

The minimum required cooling time is marked on each aquatherm electrofusion socket. Ambient temperatures of more than 25 °C or strong sun-radiation need longer cooling times.

Working pressure

The operation pressure can be taken from the imprint on the electric welding socket. The relation between working temperature, pressure load and service life is given in the tables "Permissible working pressure."

For further information concerning electrofusion socket and details about the aquatherm electrofusion device read the enclosed operating instructions.



Push the second pipe – also peeled and cleaned – into the socket

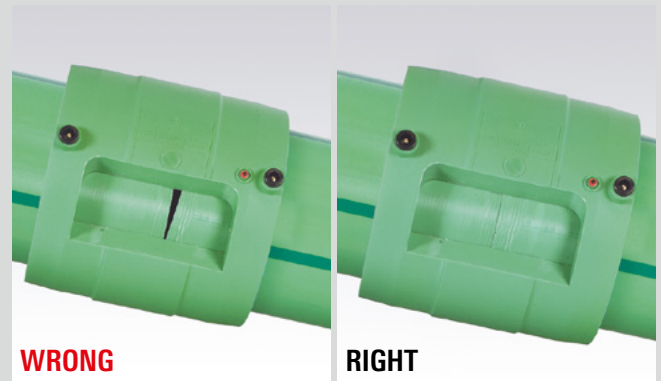

For a stable welding result it is important that both pipe ends inside the electrofusion socket are with parallel faces! Follow the minimum welding depth – absolutely!

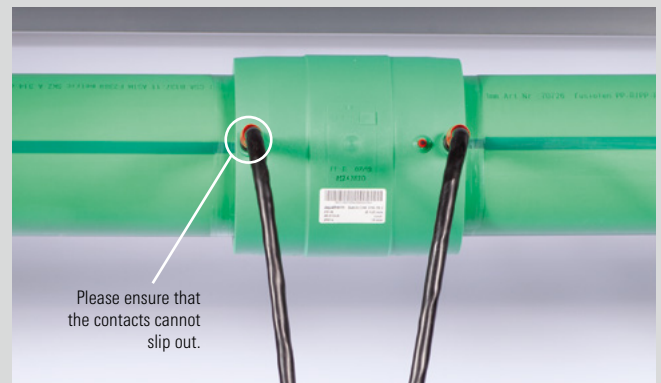

Please ensure that the contacts cannot slip out.

Adjust the socket diameter on the welding device. Start and control welding process. Keep the cooling time. Finished!

Kind of stress	Compressive stress	Minimum waiting period
Tension, bend, torsion of unpressurized pipes		20 minutes
Test- or working pressure of pipes pressurized	up to 0.1 bar (1.5 psi) 0.1 up to 1 bar (1.5–14.5 psi) over 1 bar (14.5 psi)	20 minutes 60 minutes 120 minutes
Repeating of the welding process		60 minutes

REPAIR OPTIONS

Pipe repairs with the aquatherm green pipe electrofusion socket

Cut squarely 3 to 4 lengths of a fitting out of the defect pipe, symmetrically to the defect. Fit the new pipe into this gap. Prepare the pipe ends of the existing pipe as in the case of a new welding.

Peel the new piece of pipe on both sides with the peeling tool on a length of more than the length of one fitting.

Unwrap two fittings and carefully move the fittings over both ends of the new pipe.

Then place the repair-pipe into the gap and move the fittings until they are aligned with the markings on the existing pipes.

Take care that the fittings are exactly aligned and completely free of stress before welding.

Additional possibilities of repair

Damaged pipes may be repaired by means of

fusion (see Part B)
electrofusion socket (see Part F).

In addition to this the aquatherm PP-R/PP-RP systems offers the possibility of the

pipe repair stick.

The required welding tool (Art. no. 9800050307/9800050311) and repair stick (Art. no. 1090000035).

The installation information is enclosed with the welding tool, but may also be ordered separately (Order-No. D 11450) from aquatherm.



Heat-up

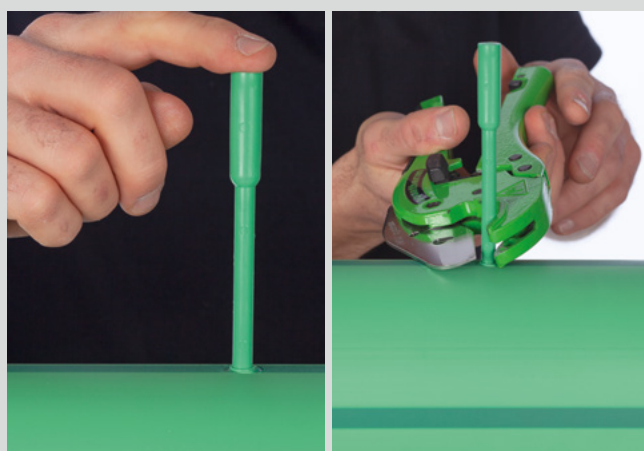

Repair stick

Cutting

**PART G: BUTT-WELDING OF PIPE DIMENSION
160–630 mm**

The following aquatherm pipes series are available:

aquatherm green pipe SDR 11 S for cold water

aquatherm green pipe SDR 7.4 / 9 / 11 MF fibre-composite pipe

aquatherm blue pipe SDR 11 / 17.6 MF fibre-composite pipe

aquatherm blue pipe SDR 11 MF OT fibre-composite pipe

Pipes and fittings are fused, as explained below, by butt welding:

1. Protect your place of work from weather influences
2. Check, if welding machine works properly and heat it up
3. Cut pipes into required length
4. Plastic pipes are aligned and fixed by means of the clamping elements
5. Use the milling machine for planing the pipe end to be plane-parallel
6. Remove the debris and clean the pipe ends with methylated spirit
7. Check if pipes match (tolerance: max. 0.1 x wall thickness)
8. Check width of gap between the two pipes to be welded (tolerance: max. 0.5 mm)
9. Check the temperature of the heating element (210 °C +/- 10 °C)
10. Clean the heating element

IMPORTANT:

Before welding, the side to be welded of the aquatherm green pipe UV must be chamfered with the aquatherm chamfering tool (page 161).

To ensure an optimal weld joint, the heating plates' surfaces have to be cleaned before each welding process and be free of visible and invisible residues.

Before welding, pipes are cut into the required lengths



Check performance of the welding machine and heat it up

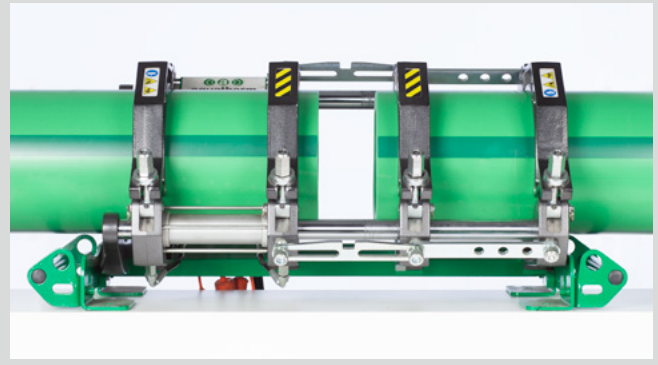

The parts to be welded are fixed and aligned respectively, the milling machine is used



Chamfering of the front side in case of the UV pipe

PART G: BUTT-WELDING OF PIPE DIMENSION

160–630 MM

11. After the heating element has been positioned, the pipes are pushed onto the heating plate with a defined adjusting pressure.
12. After reaching the specified bead height (see table) the pressure is reduced. This process marks the beginning of the heating time. This time is for heating up the pipe ends up to the right welding temperature.

Specified bead height in mm:

	SDR 7,4	SDR 11	SDR 9	SDR 17,6
160 mm	1,5	1,0	1,0	1,0
200 mm	2,0	1,0	1,5	1,0
250 mm	2,0	1,5	2,0	1,0
315 mm	-	2,0	2,0	1,0
355 mm	-	2,0	2,5	1,5
400 mm	-	2,0	-	1,5
450 mm	-	2,5	-	1,5
500 mm	-	-	-	2,0
630 mm	-	-	-	2,0

13. When heating time has expired, divide the machine slide, remove heating element quickly and join the pipes (by putting both parts of the slide together).
14. The pipes are fused with the required welding pressure and cooled down under pressure.
15. The welded connection can be unclamped – the welding process is finished.

Additionally please follow the instructions given in the operating manual of the welding machine and observe guideline DVS 2207, part 11.

Important Note

1. The welding machines have to be suitable for the welding of pipes with a diameter/wall thickness ratio of up to SDR 7.4.

aquatherm recommends the following manufacturers of welding machines for butt welding:

Company Ritmo
Company Widos

2. For hydraulically operated welding machines, the real manometer pressure has to be calculated in consideration of the hydraulic piston area.

This value can be taken from the respective operating manuals.

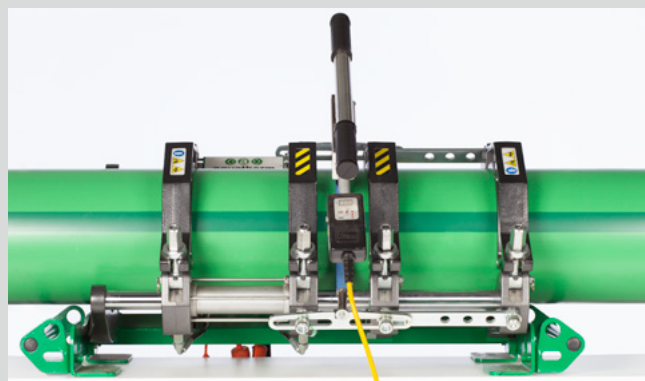

Positioning of heating element

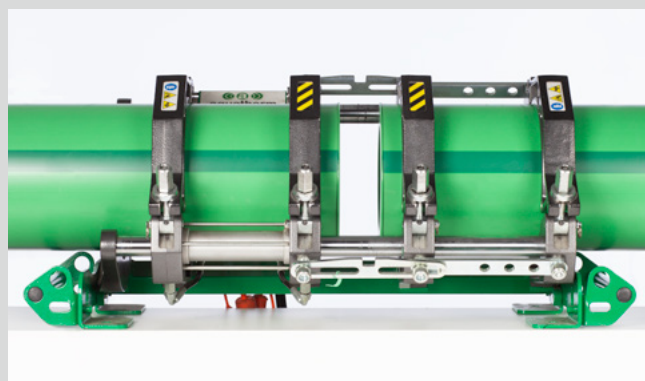

Divide the machine slide, remove heating element



Join the pipes, cool down under pressure

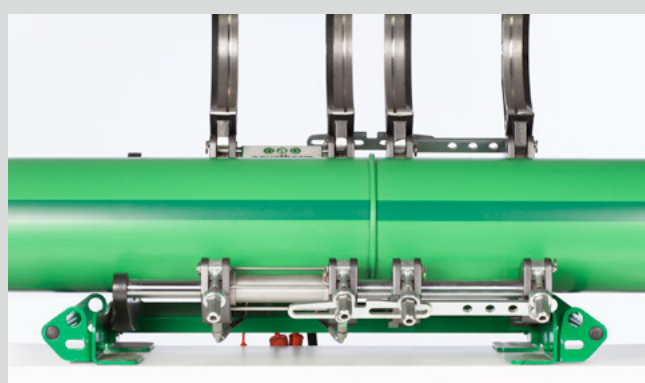

Unclamp and work on...

Visual inspection of fusion seam – Misalignment and gap width for butt welding

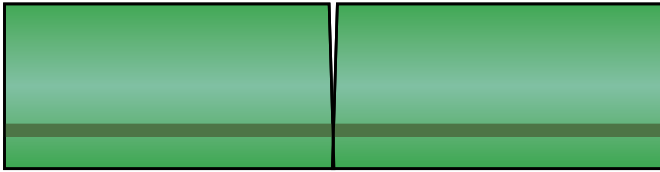

Gap width up to 355 mm outer diameter = 0.5 mm
 Gap width from 400 mm to 630 mm outer diameter = 1 mm

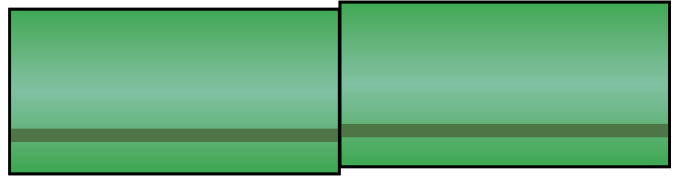

The misalignment cannot be more than 10% of the wall thickness or max. 2 mm

Welding defects during butt-welding

Normally a bead around the entire circumference is formed at the edge of the socket during the welding process. This bead indicates the proper welding. It is important to assure that the following welding defects are avoided:

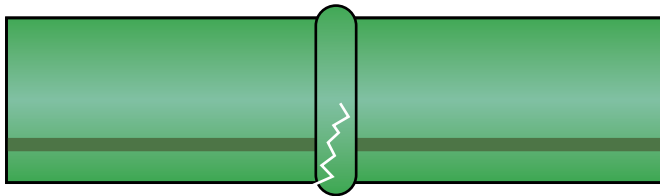

Cracks

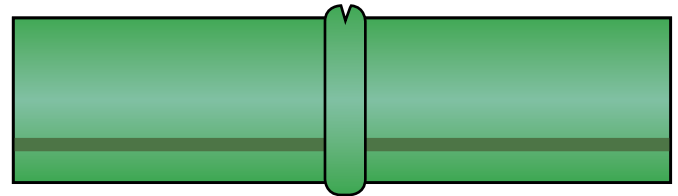

Grooves in the bead

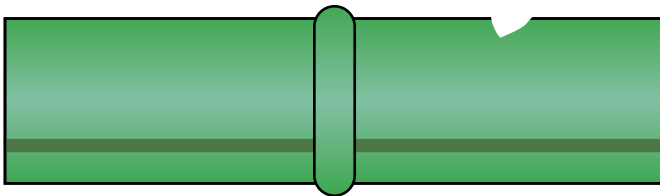

Grooves and scratches

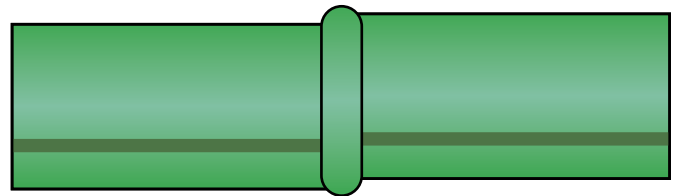

Misalignment of the joining area

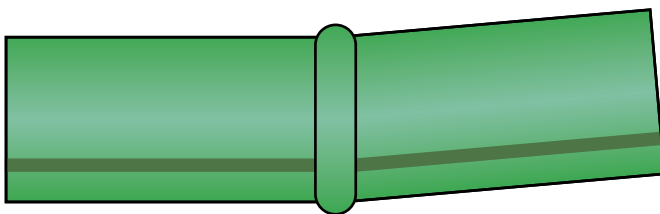

Tilting of the joining area

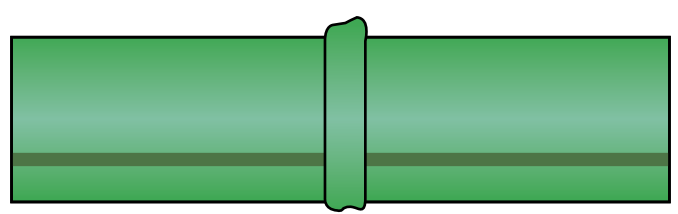

Uneven welding bead

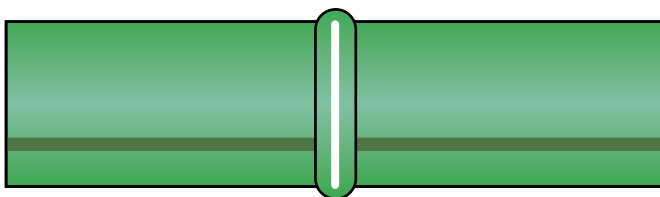

Lack of fusion at the joining area

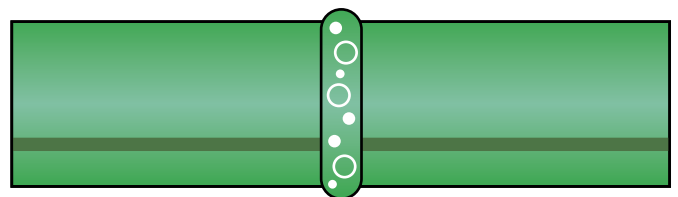

Pores, voids and inclusion of impurities

Correct butt welded seam

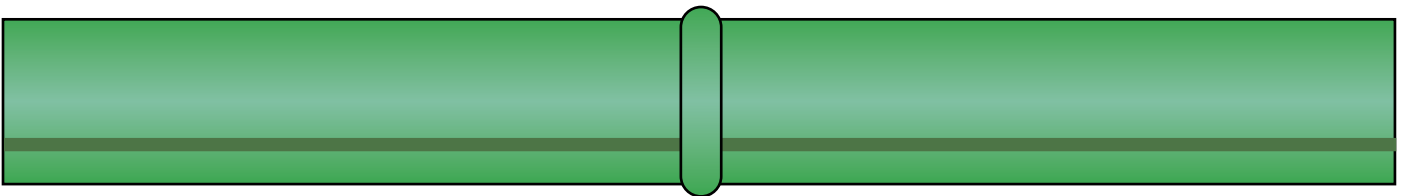
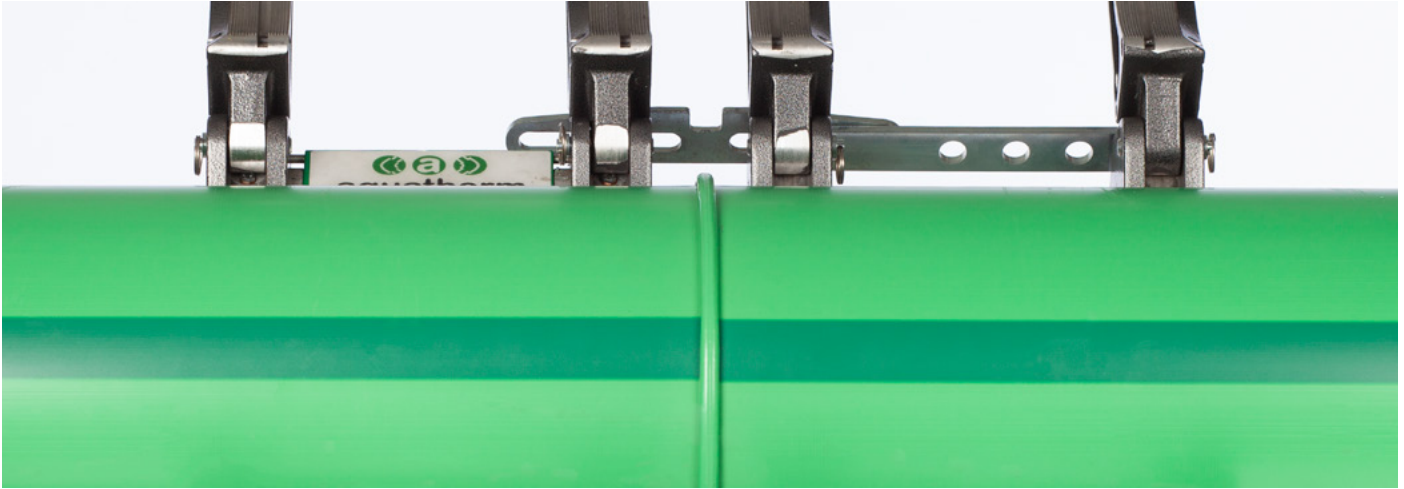

The visual inspection may be only a first indication of the welding seam quality. It is not a replacement for the leak test, which has to be carried out after the completion of the installation.

Requirements for welding



The immediate welding area is to be protected against bad climatic conditions (e.g. wind, moisture and low temperatures).



If the pipes are heated unevenly as a result of sun exposure, a temperature compensation will have to be provided by covering the welding area from time to time. Cooling down by draft during the welding process should be avoided.



For perfect welding joints, both the welding areas and tools must be clean and free of grease.

FLANGE CONNECTIONS

THE FOLLOWING MUST BE OBSERVED IN THE USE OF FLANGE CONNECTIONS:

Flange adapter respectively the sealing surfaces must always be aligned parallel to each other. A subsequent tightening of the flange connection after the welding process must be avoided. It is important to ensure that the flange faces are clean and undamaged.

The screw length should be selected so that the screw thread is as flush as possible, maximum two threads from the nut. To distribute the force of the screw head and the nut over a larger area, washers are used. Screws, nuts and washers must be clean and undamaged.

In order to achieve proper force distribution (surface pressure) acting on the seal, note the following:

- Screw joints must be tightened diagonally and evenly
- Torque information on the individual flanges must be observed (see table)

For flange connections, exposed to a mutual load, take care that they are checked as part of the maintenance and retightened, if necessary.

TORQUE FLANGE according to manufacturer's instructions

Art. no.	Dimension	DN specification	Nm
1040032130	32 mm	25	15
1040040131	40 mm	32	20
1040050132	50 mm	40	30
1040063133	63 mm	50	35
1040075134	75 mm	65	40
1040090135	90 mm	80	40
1040110136	110 mm	ohne	50
1040125137	125 mm	100	50
1040160138	160 mm	125	60
1040200139	200 mm	150	75
1040250140	250 mm	200	95
1040315141	315 mm	250	100
1040355142	355 mm	300	100
1040400143	400 mm	350	244-366
1040450144	450 mm	400	271-407
1040500145	500 mm	450	271-407
1040630146	630 mm	500	393-590

TIGHTENING SEQUENCE

Number of screws	Criss-Cross Pattern Tightening Sequence
4	1 - 3 - 2 - 4
8	1 - 5 - 3 - 7 - 2 - 6 - 4 - 8
12	1 - 7 - 4 - 10 - 2 - 8 - 5 - 11 - 3 - 9 - 6 - 12
16	1 - 9 - 5 - 13 - 3 - 11 - 7 - 15 - 2 - 10 - 6 - 14 - 4 - 12 - 8 - 16
20	1 - 11 - 6 - 16 - 3 - 13 - 8 - 18 - 5 - 15 - 10 - 20 - 4 - 14 - 9 - 19 - 7 - 17 - 2 - 12

Following the table, tighten the given screw number to the desired torque value for the given round of tightening.

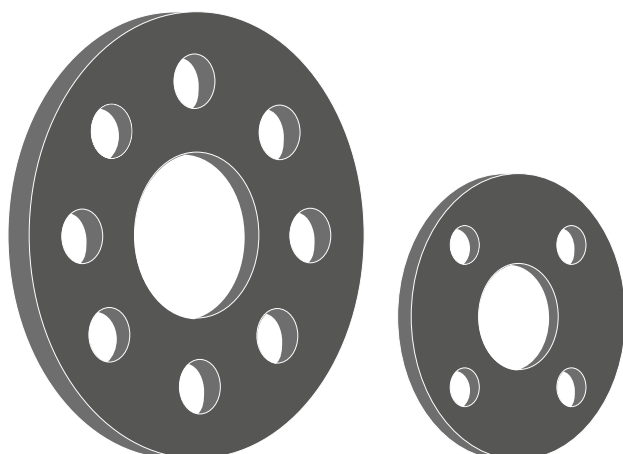
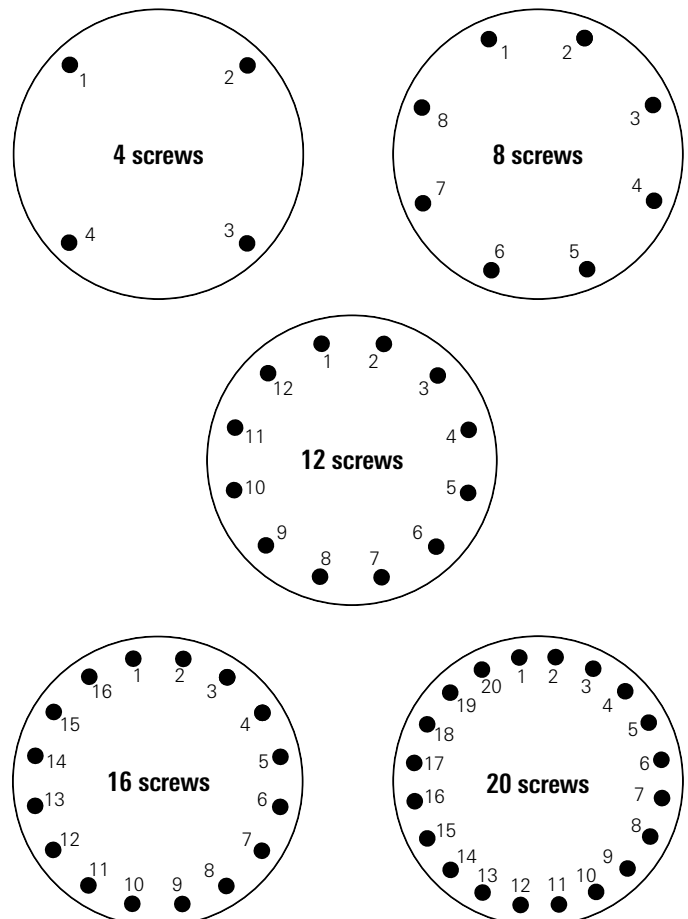

FASTENING TECHNIQUE / FIXED POINTS / SLIDING POINTS

Fastening technique

Pipe clamps for aquatherm pipes must be dimensioned for the external diameter of the plastic pipe.

Take care that the fastening material does not mechanically damage the surface of the pipe (aquatherm pipe clamps Art. no.: 9600060516–9600060660).

All pipes should be fastened with only aquatherm’s green rubber compound fasteners, with expansion spacers, or other as deemed equal or approved by aquatherm and /or the project’s Hydraulic Consultant.

Basically it must be distinguished on pipe assembly, whether the fastening material is used as

a fixed point or
a sliding point.

Fixed points

On locating fixed points the pipelines are divided into individual sections. This avoids uncontrolled movements of the pipe.

In principle fixed points have to be measured and installed in a way, that the forces of expansion of aquatherm pipes as well as probable additional loads are accommodated.

On using threaded rods or threaded screws the drop from the ceiling should be as short as possible. Swinging clamps should not be used as fixed points.

Basically vertical distributions can be installed. Risers do not require expansion loops, provided that fixed points are located immediately before or after a branch.

To compensate the forces arising from the linear expansion of the pipe there must be sufficient and stable clamps and mountings.

aquatherm pipe clamps meet all mentioned requirements and – when considering the following installation instructions – are perfect for fixed point installations.

Sliding points

Sliding clamps have to allow axial pipe movements without damaging the pipe.

On locating a sliding clamp it has to be ensured that movements of the pipelines are not hindered by fittings or armatures installed next to the clamps.

aquatherm pipe clamps have an extra even and sliding surface of the sound insulation insert.

INSTALLATION ADVICE / LINEAR EXPANSION / CONCEALED INSTALLATION

Installation advices

aquatherm pipe clamps are perfectly suited for fixed point and sliding point installations.

The application of distance rings depends on the type of pipe.

Fastening	MF Pipes (fibre composite pipe) & S Pipes (single layer)
Sliding Point	1 distance ring
Fixed point	no distance ring

Linear expansion

The linear expansion of pipes depends on the difference of operating temperature to installation temperature:

$$\Delta T = T_{\text{operating temperature}} - T_{\text{installation temperature}}$$

Therefore cold water pipes have practically no linear expansion.

Because of the heat dependent expansion of the material, the linear expansion must especially be considered in case of hot and heating installations. This requires a distinction of the types of installation, e.g.

- **Concealed installation**
- **Installation in ducts**
- **Open installation.**

Concealed installation

Concealed installations generally do not require a consideration of the expansion of aquatherm pipes.

The insulation according to DIN 1988 or the EnEV (energy saving regulation) provides enough expansion space for the pipe. In the case where the expansion is greater than the room to move in the insulation, the material absorbs any stress arising from a residual expansion.

The same applies to pipes, which do not have to be insulated according to current regulations.

A temperature induced linear expansion is prevented by the embedding in the floor, concrete or plaster. The compressive strain and tensile stress arising from this are not critical as they are absorbed by the material itself.

INSTALLATION IN DUCTS

Installation in ducts (vertical)

Due to the different linear expansion of the aquatherm pipes with or without stabilization, the installation of pipe branches in risers has to be made according to the selected type of pipe.

aquatherm green pipe MF
aquatherm blue pipe MF

The linear expansion of aquatherm fibre composite pipes in vertical risers can be ignored.

The positioning of a fixed point directly before each branch-off point is sufficient. All clamps in the riser must be installed as fixed points (see 1).

In general it is possible to install risers rigidly, that means without expansion joints. This directs the expansion on the distance between the fixed points, where it is ineffective.

When laying in duct, make sure that the distance between two fixed points is limited to a maximum of 3.0 meters.

aquatherm green pipe

The installation of risers of aquatherm pipes without stabilizing components requires a branch pipe, which is elastic enough to take the linear expansion of the riser.

This can be ensured by a favourable fixing of the riser in the duct (see 2).

An adequate large pipe liner also gives sufficient elasticity to the branch-off pipe (see 3).

Furthermore the installation of a spring leg gives the appropriate elasticity (see 4).

When laying aquatherm pipes through the wall and ceiling, the fire protection must be observed (see pages 24-26).

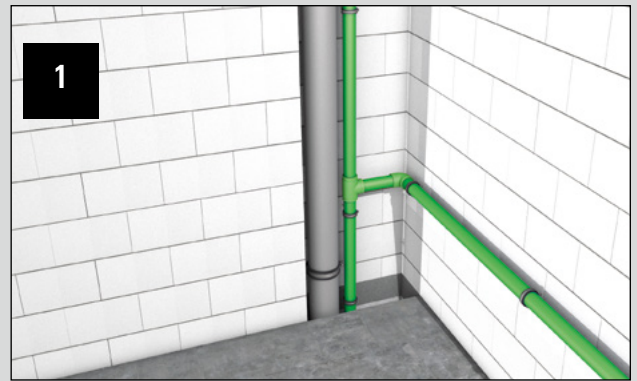

Positioning of the fixed point clamp



Favourable fixing



Large diameter pipe liner



Installation of a spring leg

OPEN INSTALLATION / CALCULATION OF THE LINEAR EXPANSION

Open installation (horizontal)

In case of open installed pipes (e.g. in the basement), excellent optical characteristics and form stability are important. aquatherm pipes for cold water and aquatherm fibre composite pipes for hot water and heating plants make this possible. The coefficient (α) of linear expansion of aquatherm composite pipes is only

$$\alpha_{\text{green pipe MS}} = 0.030 \text{ mm/mK}$$

$$\alpha_{\text{green pipe MF}} = 0.035 \text{ mm/mK}$$

and therefore nearly identical to the linear expansion of metal pipes.

The coefficient of linear expansion of aquatherm pipes without stabilizing components is

$$\alpha_{\text{green pipe}} = 0.150 \text{ mm/mK}$$

aquatherm fibre composite pipes must have enough space to expand (see below). An expansion control is required for long and straight fibre composite pipes (over 40 m).

aquatherm pipes without the stabilizing compound should have the expansion control after 10 m straight pipelines. The following formula, calculation examples, data-tables and diagrams help to determine the linear expansion. The difference between working temperature and maximum or minimum installation temperature is essential for the calculation of linear expansion.

Calculation of the linear expansion

Given and required values

Symbol	Meaning	Value	Measuring unit
ΔL	Linear expansion	?	[mm]
α_2	Coefficient of linear expansion aquatherm fibre composite pipe	0.035	mm/mK
α_3	Linear expansion coefficient	0.15	mm/mK
L	Pipe length	25.0	[m]
T_B	Working temperature	60	°C
T_M	Installation temperature	20	°C
ΔT	Temperature difference between working and installation temperature ($\Delta T = T_w - T_M$)	40	K

The linear expansion ΔL is calculated according to the following formula:

$$\Delta L = \alpha \times L \times \Delta T$$

Example:

aquatherm green pipe MF fibre composite pipe ($a = 0.035 \text{ mm/mK}$)

$$\Delta L = 0.035 \text{ mm/mK} \times 25.0 \text{ m} \times 40 \text{ K}$$

$$\Delta L = 35.0 \text{ mm}$$

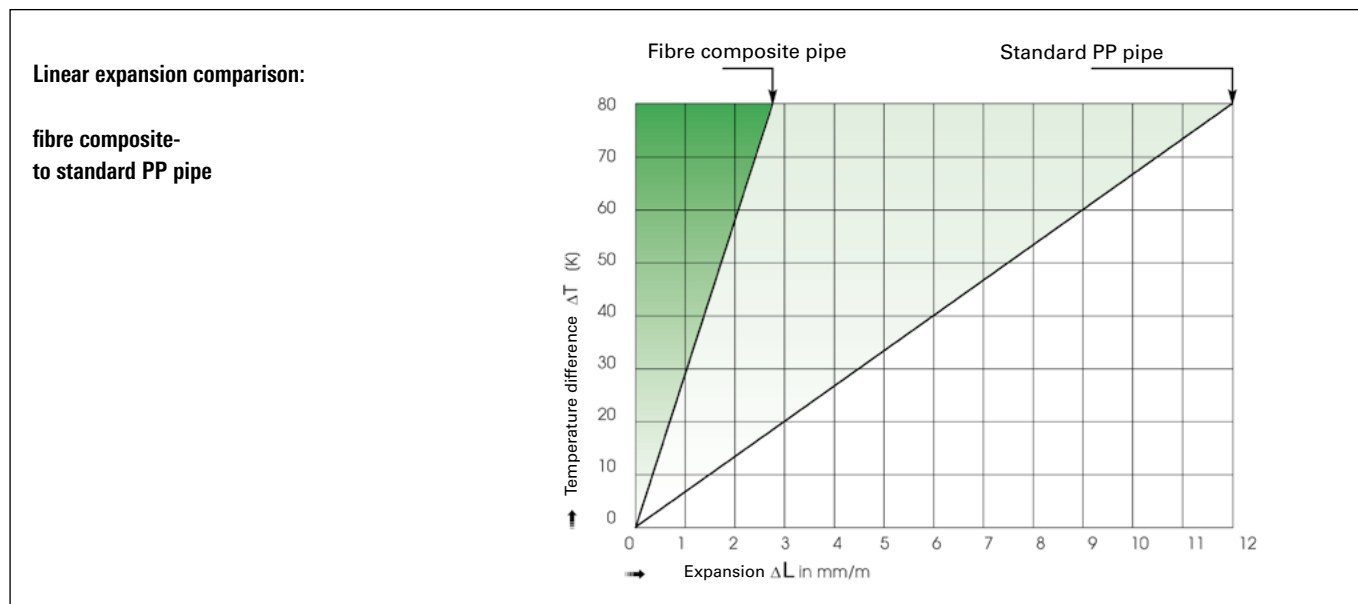

LINEAR EXPANSION

aquatherm green pipe

(without fibre)

The linear expansion, described on the preceding pages, can be taken from the following tables and graphs.

Linear expansion ΔL in [mm]: green and blue pipe - $\alpha = 0.150$ mm/mK

Pipe length	Difference in temperature $\Delta T = T_{\text{operating temperature}} - T_{\text{installation temperature}}$							
	10 K	20 K	30 K	40 K	50 K	60 K	70 K	80 K
	Linear expansion ΔL (mm)							
5 m	8	15	23	30	38	45	53	60
10 m	15	30	45	60	75	90	105	120
15 m	23	45	68	90	113	135	158	180
20 m	30	60	90	120	150	180	210	240
25 m	38	75	113	150	188	225	263	300
30 m	45	90	135	180	225	270	315	360
35 m	53	105	158	210	263	315	368	420
40 m	60	120	180	240	300	360	420	480
45 m	68	135	203	270	338	405	473	540
50 m	75	150	225	300	375	450	525	600

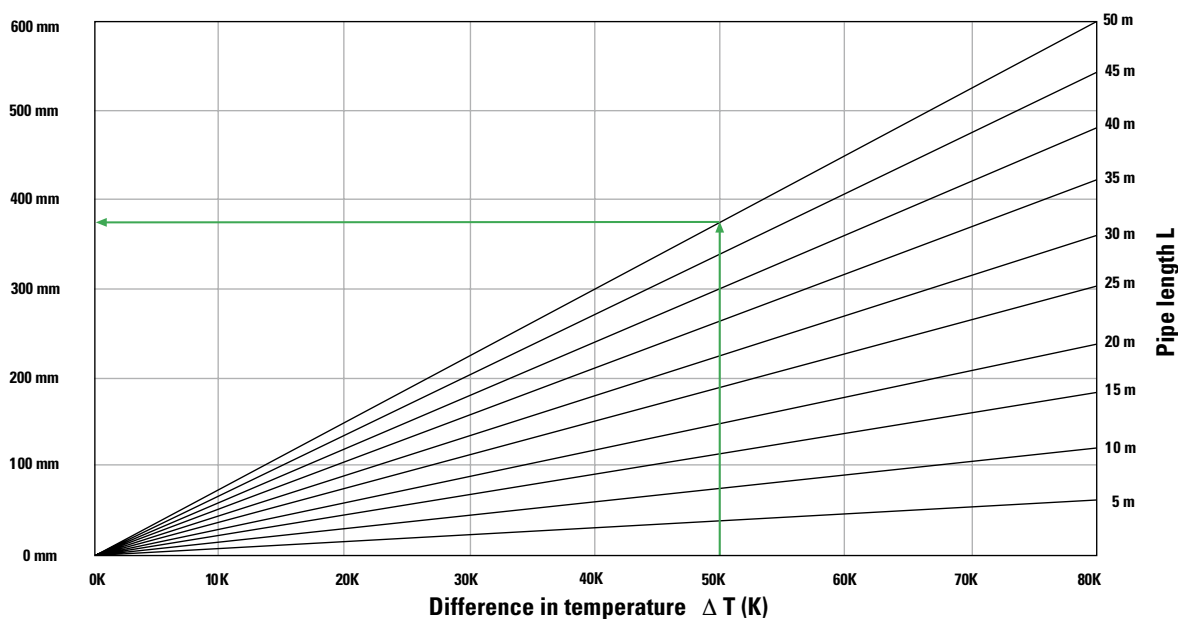

LINEAR EXPANSION

aquatherm green pipe MF (fibre composite pipe)

Due to the integration and positive bond of the different materials, the aquatherm fibre composite pipes offer much higher stability. The linear expansion reduces its value to $\frac{1}{5}$ of the mere PP pipes.

Linear expansion ΔL in [mm]: aquatherm fibre composite pipes - $\alpha = 0.035$ mm/mK

Pipe length	Difference in temperature $\Delta T = T_{\text{operating temperature}} - T_{\text{installation temperature}}$							
	10 K	20 K	30 K	40 K	50 K	60 K	70 K	80 K
	Linear expansion ΔL (mm)							
10 m	4	7	11	14	18	21	25	28
20 m	7	14	21	28	35	42	49	56
30 m	11	21	32	42	53	63	74	84
40 m	14	28	42	56	70	84	98	112
50 m	18	35	53	70	88	105	123	140
60 m	21	42	63	84	105	126	147	168
70 m	25	49	74	98	123	147	172	196
80 m	28	56	84	112	140	168	196	224
90 m	32	63	95	126	158	189	221	252
100 m	35	70	105	140	175	210	245	280

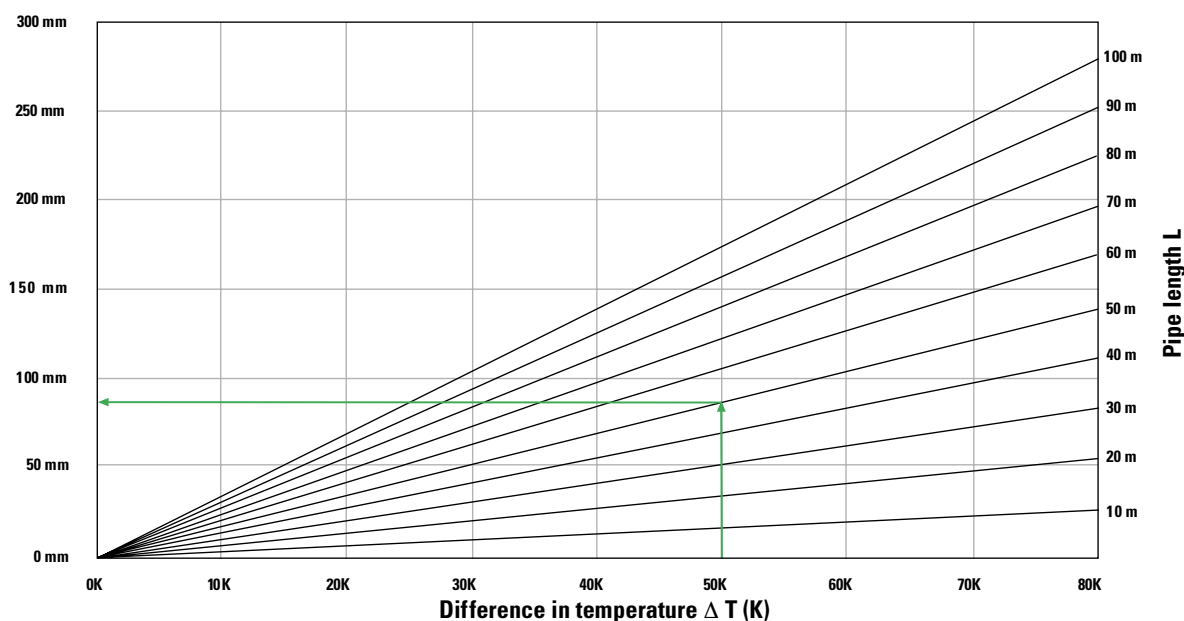

PIPE CLAMPS suitable as fixing point

aquatherm offers fixed-point fastenings for pipes from 160 mm–630 mm (Art. no. 9600060768–9600060790). Packing unit is each with 1 piece.

Advantages:

- Reliable and permanent protection against perforation corrosion and breakdown of the static load capacity
- 1000 hours salt spray test without ferric oxide (rust)
- Suitable for installation in corrosive inner and outside areas
- Considerably higher corrosion protection than with electrogalvanized and hot-dip galvanized products (after spread test according to DIN EN ISO 9227)

Art. no.	diameter	min. torque clamp locking	min. torque height adjustment	height adjustment	fixing on building	measure „a”	weight per set
[-]	[mm]	[Nm]	[Nm]	[mm]	[-]	[mm]	[kg]
9600060768	160	25	75	192,5–283,5	M 12	354,1	8,55
9600060770	200	25	75	192,5–283,5	M 12	394,5	9,45
9600060774	250	50	75	192,5–283,5	M 12	444,8	19,37
9600060778	315	50	75	192,5–283,5	M 12	510	22,75
9600060780	355	50	75	192,5–283,5	M 12	550,1	24,84

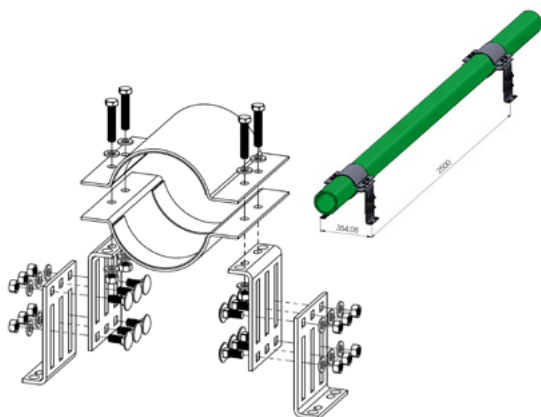

art.-no.	diameter	min. torque clamp locking	min. torque height adjustment	height adjustment	fixig on building	measure „a”	weight per set
[-]	[mm]	[Nm]	[Nm]	[mm]	[-]	[mm]	[kg]
9600060782	400	50	120	404,5–497,5	M16	823,2	43,64
9600060784	450	50	120	404,5–497,5	M16	873,3	46,25
9600060786	500	50	120	404,5–497,5	M16	923,4	48,87
9600060790	630	50	120	404,5–497,5	M16	1053,5	55,66

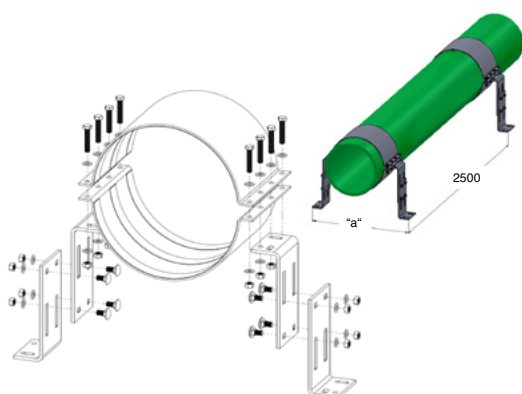

BENDING SIDE

Linear expansion due to temperature difference between operating temperature and installation temperature can be compensated by different installation techniques.

Bending side

In most cases direction changes can be used to compensate for linear expansion in pipes.

The values of the bending side can be taken directly from the tables and graphs on the following pages.

Symbol	Meaning	
L_{BS}	Length of the bending side	[mm]
K	Material specific constant	15,0
d	Outside diameter	[mm]
ΔL	Linear expansion	[mm]
L	Pipe Length	[m]
FP	Fixed point	
GP	Sliding point	

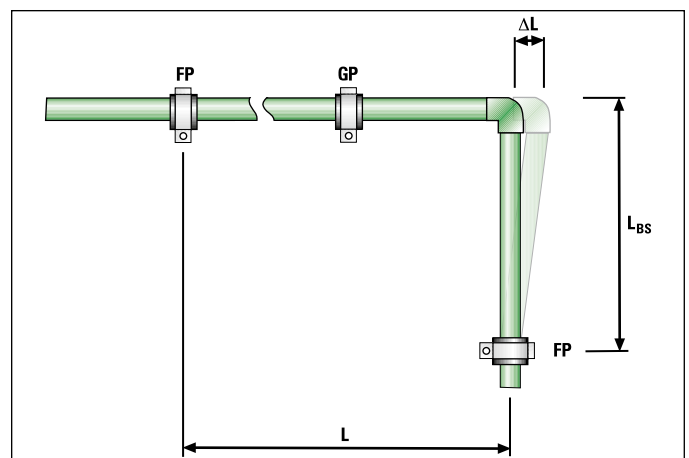

Calculational determination of the bending side length

$$L_{BS} = K \times \sqrt{d \times \Delta L}$$

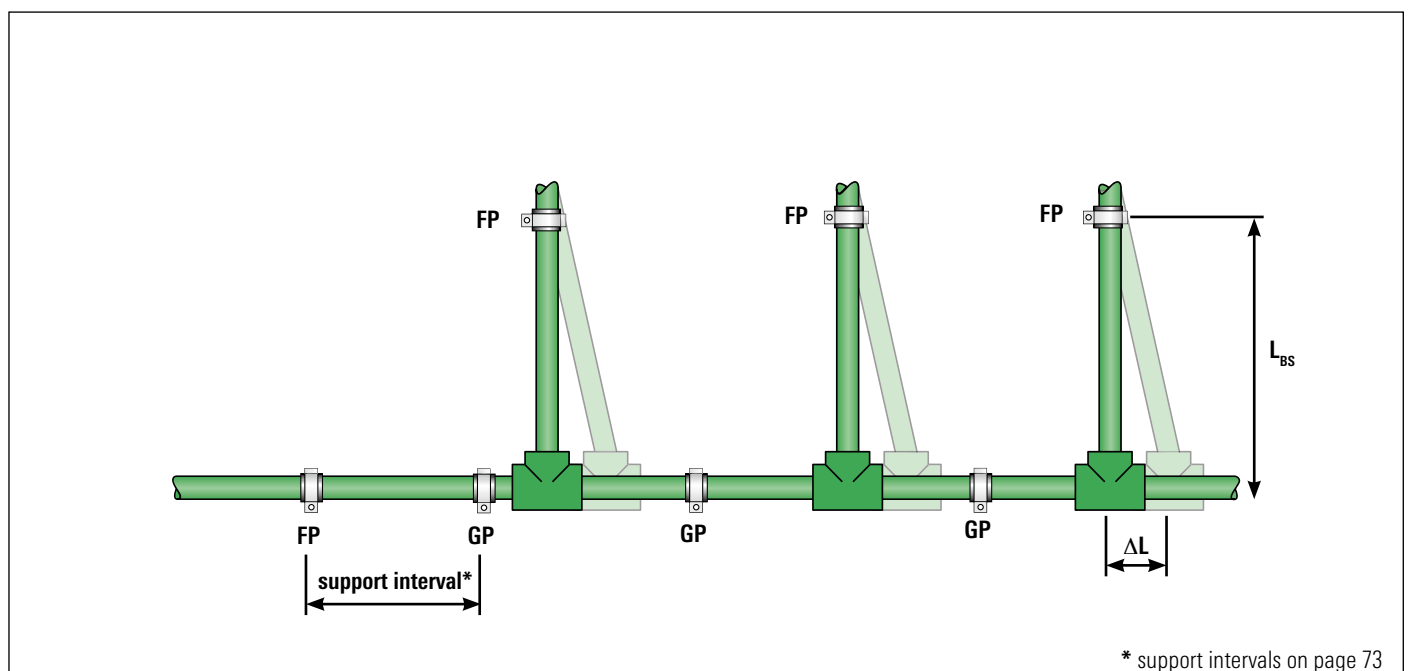

* support intervals on page 73

PRE-STRESS / BELLOW EXPANSION JOINT
Expansion loop

If the linear expansion cannot be compensated by a change in direction, it will be necessary to install an expansion loop with long and straight pipelines.

In addition to the length of the bending side L_{BS} the width of the pipe bend A_{min} must be considered.

Symbol	Meaning	
A_{min}	Width of the expansion loop	[mm]
SA	Safety distance	150 mm

The pipe bend A_{min} is calculated according to the following formula:

$$A_{min} = 2 \times \frac{\Delta L}{2} + SA$$

The width of the expansion loop A_{min} should be at least 210 mm.

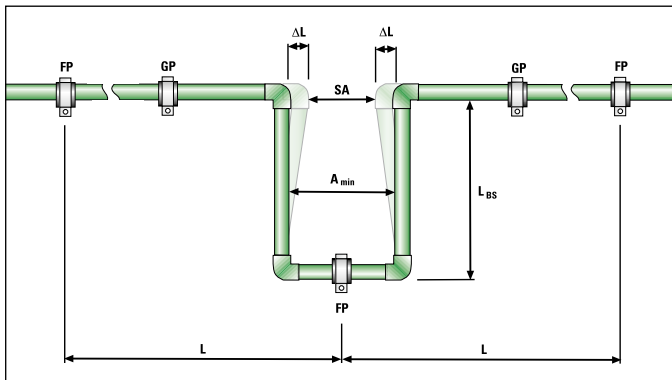

Determination size of expansion loop

Example

Specification: Pipeline, length 80 m (MF pipe)

Determined expansion: $112 \text{ mm} = (\Delta L = \frac{0,035 \text{ mm}}{\text{mK}} \times 80 \text{ m} \times 40 \text{ K})$

The expansion loop should be installed exactly in the center of the pipe.

Calculation:

Given: $\Delta L = 112 \text{ mm}$
 $SA = 150 \text{ mm}$

Formula:

$$A_{min} = 2 \times \frac{\Delta L}{2} + SA$$

$$A_{min} = 2 \times \frac{112 \text{ mm}}{2} + 150 \text{ mm}$$

$$A_{min} = 262 \text{ mm}$$

The width of the expansion loop should be 262 mm in this example.

Pre-stress

Where space is limited, it is possible to shorten the total width A_{min} as well as the length of the bending side L_{BSV} by pre-stressing.

Pre-stress installations, if planned and carried out carefully, offer an optically perfect installation, as the linear expansion is hardly visible.

Symbol	Meaning	
L_{BSV}	Length of pre-stress	[mm]

The side length of expansion loops with pre-stress is calculated according to the following example:

$$L_{BSV} = K \times \sqrt{d \times \frac{\Delta L}{2}}$$

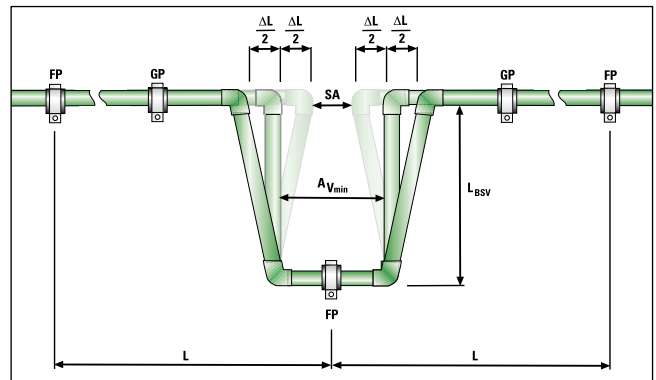

Below expansion joint

All bellow expansion joints for corrugated pipes designed for metal materials are unsuitable for aquatherm PP-R pipes.

When using axial expansion joints observe the manufacturer's instructions.

LENGTH OF BENDING SIDE

for aquatherm PP-R pipes – the length of the bending side with pre-stress L_{BSV} can be taken from the tables and graphs in consideration of the applied pipe dimensions and determined linear expansion.

Pipe Dimension	Linear expansion (mm)											
	10	20	30	40	50	60	70	80	90	100	110	120
	Length of bending side (m)											
20 mm	0,21	0,30	0,37	0,42	0,47	0,52	0,56	0,60	0,64	0,67	0,70	0,73
25 mm	0,24	0,34	0,41	0,47	0,53	0,58	0,63	0,67	0,71	0,75	0,79	0,82
32 mm	0,27	0,38	0,46	0,54	0,60	0,66	0,71	0,76	0,80	0,85	0,89	0,93
40 mm	0,30	0,42	0,52	0,60	0,67	0,73	0,79	0,85	0,90	0,95	0,99	1,04
50 mm	0,34	0,47	0,58	0,67	0,75	0,82	0,89	0,95	1,01	1,06	1,11	1,16
63 mm	0,38	0,53	0,65	0,75	0,84	0,92	1,00	1,06	1,13	1,19	1,25	1,30
75 mm	0,41	0,58	0,71	0,82	0,92	1,01	1,09	1,16	1,23	1,30	1,36	1,42
90 mm	0,45	0,64	0,78	0,90	1,01	1,10	1,19	1,27	1,35	1,42	1,49	1,56
110 mm	0,50	0,70	0,86	0,99	1,11	1,22	1,32	1,41	1,49	1,57	1,65	1,72
125 mm	0,53	0,75	0,92	1,06	1,19	1,30	1,40	1,50	1,59	1,68	1,76	1,84
160 mm	0,60	0,85	1,04	1,20	1,34	1,47	1,59	1,70	1,80	1,90	1,99	2,08
200 mm	0,67	0,95	1,16	1,34	1,50	1,64	1,77	1,90	2,01	2,12	2,22	2,32
250 mm	0,75	1,06	1,30	1,50	1,68	1,84	1,98	2,12	2,25	2,37	2,49	2,60
315 mm	0,84	1,19	1,46	1,68	1,88	2,06	2,23	2,38	2,53	2,66	2,79	2,92
355 mm	0,89	1,26	1,55	1,79	2,00	2,19	2,36	2,53	2,68	2,83	2,96	3,10
400 mm	0,95	1,34	1,64	1,90	2,12	2,32	2,51	2,68	2,85	3,00	3,15	3,29
450 mm	1,01	1,42	1,74	2,01	2,25	2,46	2,66	2,85	3,02	3,18	3,34	3,49
500 mm	1,06	1,50	1,84	2,12	2,37	2,60	2,81	3,00	3,18	3,35	3,52	3,67
630 mm	1,19	1,68	2,06	2,38	2,66	2,92	3,15	3,37	3,57	3,76	3,95	4,12

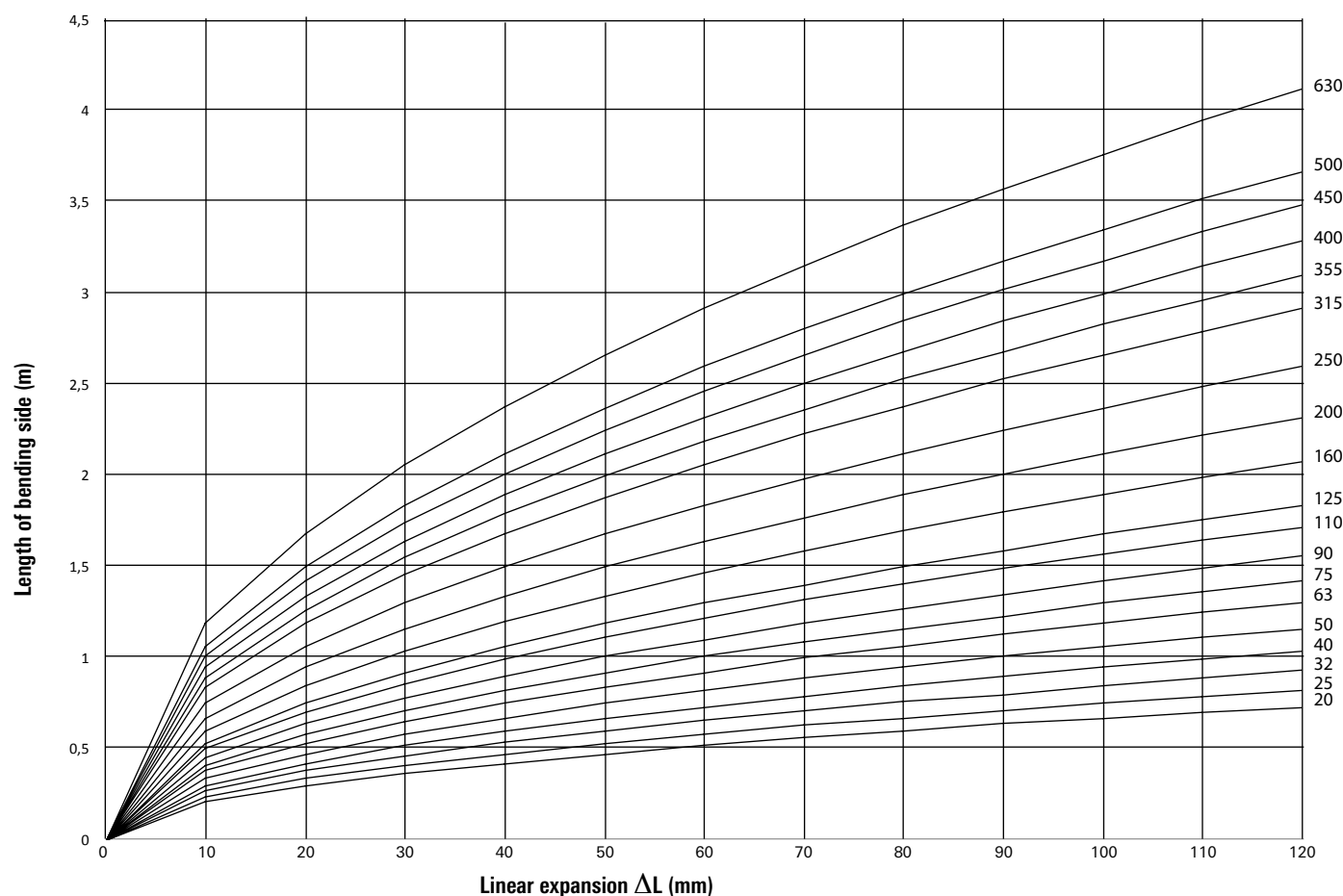

LENGTH OF BENDING SIDE WITH PRE-STRESS

For aquatherm PP-R pipes – the length of the bending side with pre-stress L_{BSV} can be taken from the tables and graphs in consideration of the applied pipe dimensions and determined linear expansion.

Pipe Dimension	Linear expansion (mm)											
	10	20	30	40	50	60	70	80	90	100	110	120
	Length of bending side (m)											
20 mm	0,15	0,21	0,26	0,30	0,34	0,37	0,40	0,42	0,45	0,47	0,50	0,52
25 mm	0,17	0,24	0,29	0,34	0,38	0,41	0,44	0,47	0,50	0,53	0,56	0,58
32 mm	0,19	0,27	0,33	0,38	0,42	0,46	0,50	0,54	0,57	0,60	0,63	0,66
40 mm	0,21	0,30	0,37	0,42	0,47	0,52	0,56	0,60	0,64	0,67	0,70	0,73
50 mm	0,24	0,34	0,41	0,47	0,53	0,58	0,63	0,67	0,71	0,75	0,79	0,82
63 mm	0,27	0,38	0,46	0,53	0,60	0,65	0,70	0,75	0,80	0,84	0,88	0,92
75 mm	0,29	0,41	0,50	0,58	0,65	0,71	0,77	0,82	0,87	0,92	0,96	1,01
90 mm	0,32	0,45	0,55	0,64	0,71	0,78	0,84	0,90	0,95	1,01	1,06	1,10
110 mm	0,35	0,50	0,61	0,70	0,79	0,86	0,93	0,99	1,06	1,11	1,17	1,22
125 mm	0,38	0,53	0,65	0,75	0,84	0,92	0,99	1,06	1,13	1,19	1,24	1,30
160 mm	0,42	0,60	0,73	0,85	0,95	1,04	1,12	1,20	1,27	1,34	1,41	1,47
200 mm	0,47	0,67	0,82	0,95	1,06	1,16	1,25	1,34	1,42	1,50	1,57	1,64
250 mm	0,53	0,75	0,92	1,06	1,19	1,30	1,40	1,50	1,59	1,68	1,76	1,84
315 mm	0,60	0,84	1,03	1,19	1,33	1,46	1,58	1,68	1,79	1,88	1,97	2,06
355 mm	0,63	0,89	1,09	1,26	1,41	1,55	1,67	1,79	1,90	2,00	2,10	2,19
400 mm	0,67	0,95	1,16	1,34	1,50	1,64	1,77	1,90	2,01	2,12	2,22	2,32
450 mm	0,71	1,01	1,23	1,42	1,59	1,74	1,88	2,01	2,13	2,25	2,36	2,46
500 mm	0,75	1,06	1,30	1,50	1,68	1,84	1,98	2,12	2,25	2,37	2,49	2,60
630 mm	0,84	1,19	1,46	1,68	1,88	2,06	2,23	2,38	2,53	2,66	2,79	2,92

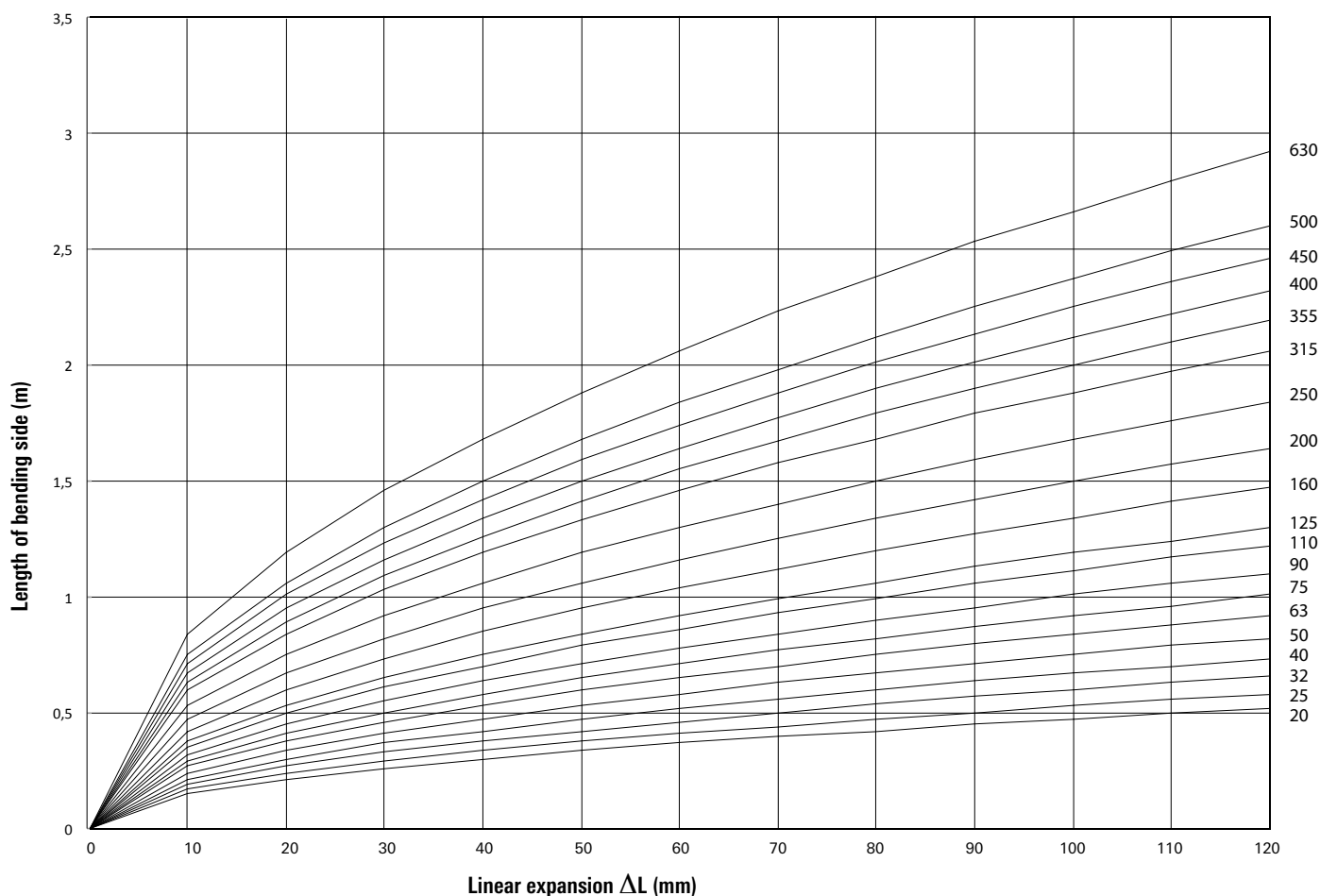

SUPPORT INTERVALS

aquatherm green pipe SDR 6 S

Table to determine support intervals in conjunction with temperature and outside diameter.

Difference in temperature ΔT [K]	Pipe diameter d (mm)									
	16	20	25	32	40	50	63	75	90	110
	Support intervals in cm									
0	70	85	105	125	140	165	190	205	220	250
20	50	60	75	90	100	120	140	150	160	180
30	50	60	75	90	100	120	140	150	160	180
40	50	60	70	80	90	110	130	140	150	170
50	50	60	70	80	90	110	130	140	150	170
60	50	55	65	75	85	100	115	125	140	160
70	50	50	60	75	80	95	105	115	125	140

aquatherm green pipe SDR 11 S

Table to determine support intervals in conjunction with temperature and outside diameter.

Pipe diameter d (mm)														
20	25	32	40	50	63	75	90	110	125	160	200	250	315	355
Support intervals in cm														
60	75	90	100	120	140	150	160	180	200	260	265	275	280	285

SUPPORT INTERVALS

aqualtherm green pipe SDR 7.4 MF (fibre composite pipes)

Table to determine support intervals in conjunction with temperature and outside diameter.

Difference in temperature ΔT [K]	Pipe diameter d (mm)		
	20	25	32
	Support intervals in cm		
0	120	140	160
20	90	105	120
30	90	105	120
40	85	95	110
50	85	95	110
60	80	90	105
70	70	80	95

Pipe clamp distances of vertically installed pipes can be increased by 20 % of the tabular values, e.g. to multiply the tabular value by 1.2.

aqualtherm green pipe SDR 9 MF RP (fibre composite pipe)

Table to determine support intervals in conjunction with temperature and outside diameter.

Difference in temperature ΔT [K]	Pipe diameter d (mm)												
	32	40	50	63	75	90	110	125	160	200	250	315	355
	Support intervals in cm												
0	155	175	200	225	240	255	285	300	310	315	325	335	340
20	115	130	150	170	180	190	210	225	225	240	245	250	255
30	115	130	150	170	180	190	200	210	215	225	230	240	245
40	105	120	140	160	170	180	190	200	205	215	225	225	230
50	105	120	140	160	170	180	180	185	195	205	215	220	220
60	100	115	130	150	160	170	170	175	185	195	200	205	210
70	90	105	125	140	155	155	160	165	175	185	190	200	205

Pipe clamp distances of vertically installed pipes can be increased by 20 % of the tabular values, e.g. to multiply the tabular value by 1.2.

THERMAL INSULATION OF HOT WATER PIPES

minimum insulation thickness in [mm] against condensation

Medium temperature 5°C – thermal conductivity value of insulation 0.040 W/(mK)												
Dimension	humidity	ambient temperature										
		20°C	22°C	24°C	26°C	28°C	30°C	32°C	34°C	36°C	38°C	40°C
75 mm	50 %		1	1	2	2	3	3	4	4	5	5
	60 %	2	3	3	4	5	5	6	7	7	8	8
	70 %	5	6	7	8	8	9	10	11	12	13	13
	80 %	9	11	12	14	15	17	18	19	20	21	22
110 mm	50 %				1	2	2	3	3	4	4	4
	60 %	1	2	3	3	4	5	5	6	7	7	8
	70 %	4	5	6	7	8	9	10	10	11	12	13
	80 %	9	11	12	14	15	17	18	19	20	21	22
160 mm	50 %						1	1	2	2	3	3
	60 %		1	1	2	3	4	4	5	5	6	7
	70 %	3	4	5	6	7	8	9	9	11	11	12
	80 %	8	10	11	13	14	16	17	19	20	21	22

The decree for energy saving thermal protection and energy saving installation engineering for buildings (EnEV energy saving regulation) regulates the thermal insulation of hot water supplies and fittings in Germany.

Central heating pipes, line 1–4 installed in heated rooms or building parts between heated rooms of the one user, where heat output can be controlled by open stop valves do not require a minimum thickness of the insulation.

This even applies to hot water pipes up to an inner diameter of 22 mm in flats, which are neither in the circulation nor have an additional electric heating.

Applying material with thermal conductivities different to 0.035 W/(mK) the minimum thickness of the insulation has to be converted correspondingly.

For the conversion and the thermal conductivity of the insulation the ways and values of calculation described in the technical regulations must be applied.

The minimum insulation according to the table for heating distributions and heating pipes can be reduced as far as the same limit of heat output even for further insulation requirements in consideration of the insulating effect of the pipe walls are guaranteed.

Cooling pipes must be provided with suitable insulation to prevent condensation. For further information please contact our service hotline +49 2722 950 200

EnEV 2009, § 14, addendum 5, chart 1

Line	Type of pipe/fitting	minimum thickness of insulation referred to thermal conductivity of 0.035 W/(mK)
1	inner diameter up to 22 mm	20 mm
2	inner diameter more than 22 mm up to 35 mm	30 mm
3	inner diameter more than 35 mm up to 100 mm	same as inner diameter
4	inner diameter more than 100 mm	100 mm
5	pipes and fittings after line 1–4 in wall- and ceiling openings, in crossing area of pipes, at pipe connections, at distributors	½ of the requirements of line 1 to 4
6	pipes of central heating after line 1–4, which have been installed after introduction of this decree between heated rooms of various users	½ of the requirements of line 1 to 4
7	pipes after line 6 in floor construction	6 mm
8	Cooling distribution and cold water pipes and fittings of air handling and air conditioning systems	6 mm

INSULATION THICKNESS ACCORDING TO ENERGY SAVING REGULATION

According to energy saving regulation (EnEV) aquatherm pipes and fittings have to be insulated against loss of heat. The insulation thickness depends on the respective installation.

The heat conductivity figure of fusiolen® PP-R is 0.15 W/(mK). aquatherm pipes and fittings offer a significantly higher degree of insulation compared to metal pipes.

Due to the high insulation values of fusiolen® the insulation thickness – compared to metal pipe systems – can be reduced.

Undermentioned are the recommendation based on EnEV 2009. Regional standards might vary and are to be considered.

Thermal insulation from heat distribution and hot water pipes, cooling distribution and cold water pipes according to EnEV 2009

Minimum thickness of insulation referred to thermal conductivity of 0.035 W/(mK)

pipe diameter	50 %	100 %
16 mm	10 mm	20 mm
20 mm	10 mm	20 mm
25 mm	10 mm	20 mm
32 mm	15 mm	30 mm
40 mm	15 mm	30 mm
50 mm	18 mm	35 mm
63 mm	23 mm	45 mm
75 mm	28 mm	55 mm
90 mm	33 mm	65 mm
110 mm	40 mm	80 mm
125 mm	45 mm	90 mm
160 mm	50 mm	100 mm
200 mm	50 mm	100 mm
250 mm	50 mm	100 mm
315 mm	50 mm	100 mm
355 mm	50 mm	100 mm
400 mm	50 mm	100 mm
450 mm	50 mm	100 mm
500 mm	50 mm	100 mm
630 mm	50 mm	100 mm

* The insulation thickness has to be calculated due to the thermal conductivity of polypropylene pipes acc. to test report no.: G.2 - 136/97 of FIW-Munich

PRESSURE TEST/TEST CONTROL/ MEASURING OF THE TEST PRESSURES/TEST RECORD

Pressure test/Test control

All aquatherm pipe systems shall be subjected to a hydraulic pressure test with a test pressure of 10 bar.

The material properties of the aquatherm pipe systems result in an expansion of the pipes during the pressure test. This affects the test result. Due to the thermal expansion coefficients of the aquatherm pipe systems the results are influenced additionally. The temperature differences between the pipe and the test medium lead to changes in pressure. Hereby a temperature change of 10 K corresponds to a pressure difference of 0.5 up to 1 bar.

Therefore pressure testing of the aquatherm pipe systems should be made with a constant temperature of the test medium. The hydraulic pressure test requires a preliminary, principal and final test.

In the preliminary test a pressure of **18 bar*** is applied 3 x 5 minutes for the expansion/release of the pipes. Between the cycles the pipe system must be depressurized.

Immediately after the preliminary test the principal test should be performed. The test duration is 15 min. Here, the test pressure (10 bar) may not fall more than 0.5 bar.

After completion of the preliminary and principle test finally the final test must be performed.

The test duration is 60 minutes. Here, the test pressure – read after the principle test – may not fall more than 0.5 bar.

Measuring of the test pressures

When measuring the system use a pressure measuring device that is able to read a pressure change of 0.1 bar. Place the measuring device at the lowest point (highest static pressure) of the installation.

Test record

A record of the hydraulic pressure test has to be prepared and signed by the client and contractor stating place and date (see page 79).

* Exception: aquatherm blue pipe SDR 17.6: 10 bar

LEAKAGE TEST/PRESSURE DIAGRAM

PRELIMINARY TEST

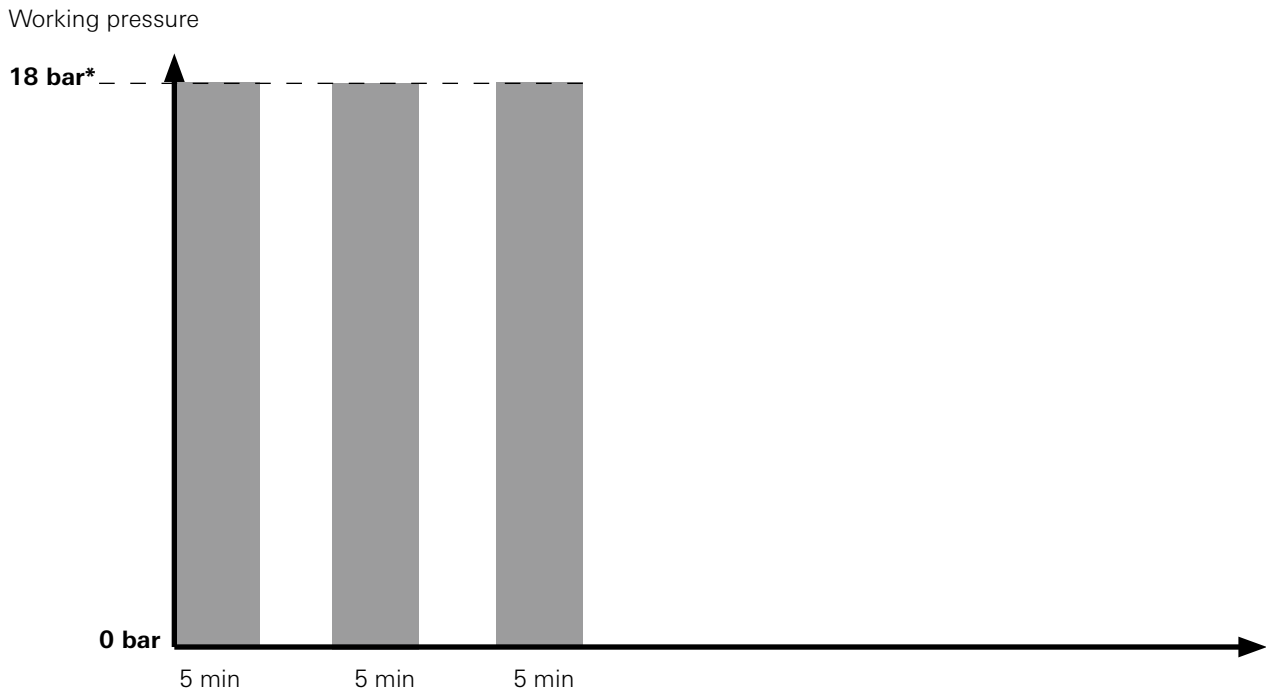

PRINCIPAL AND FINAL TEST

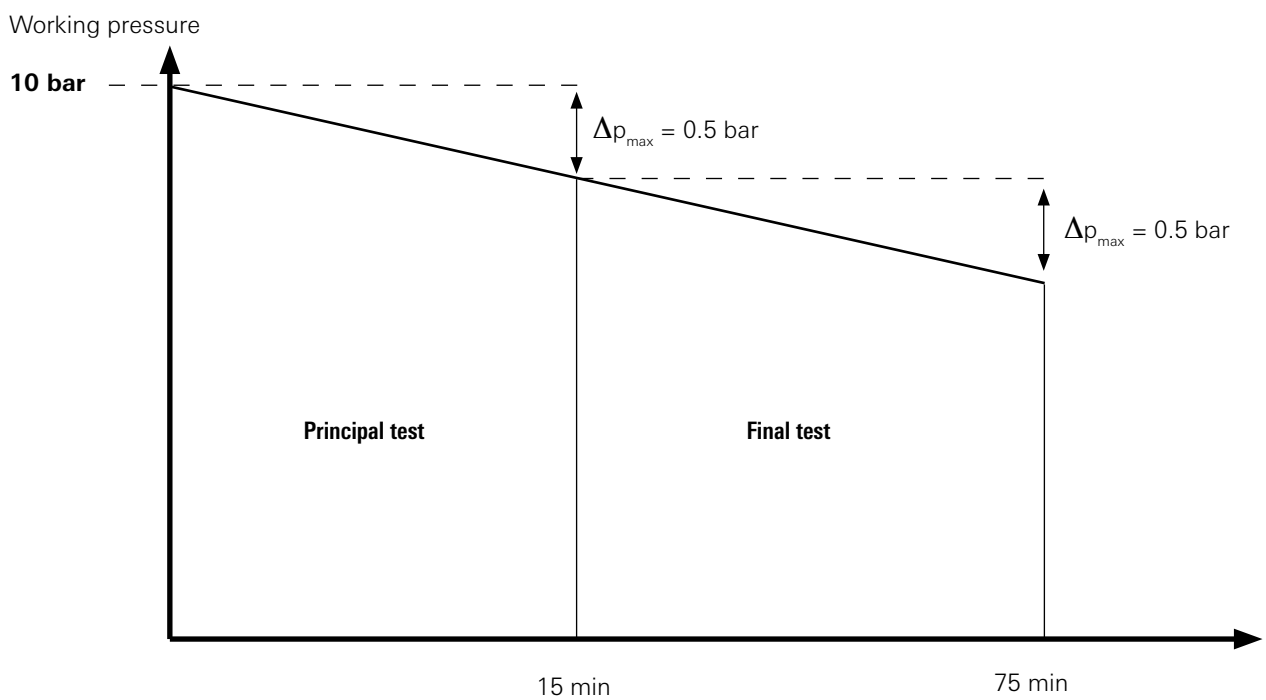

* Exception: aquatherm blue pipe SDR 17.6: 10 bar

TEST RECORD AQUATHERM SYSTEM INSTALLATION

Place: _____

Object: _____

Note before the test:

3 x 5 minutes system pressure of 18 bar or 10 bar for expansion/release of the pipes are required.

Preliminary test for SDR 6, SDR 7.4, SDR 9 and SDR 11

The pipe system must be unpressurized between each cycle.

18 bar 5 min realized: yes no

18 bar 5 min realized: yes no

18 bar 5 min realized: yes no

Preliminary test for SDR 17.6

The pipe system must be unpressurized between each cycle.

10 bar 5 min realized: yes no

10 bar 5 min realized: yes no

10 bar 5 min realized: yes no

Principal test

Test pressure: **10** bar

Pressure decline after 15 min: _____ bar **max. 0.5 bar**

Final test

(directly after the principal test, without changing the pressure)

Result principal test: _____ bar

Pressure decline after 60 min: _____ bar **max. 0.5 bar**

Notes: _____

 Place, Date

 Stamp/Signature

DESCRIPTION OF INSTALLATION

Place: _____

Object: _____

Pipe length:

Ø 20 mm	_____	m	Ø 160 mm	_____	m
Ø 25 mm	_____	m	Ø 200 mm	_____	m
Ø 32 mm	_____	m	Ø 250 mm	_____	m
Ø 40 mm	_____	m	Ø 315 mm	_____	m
Ø 50 mm	_____	m	Ø 355 mm	_____	m
Ø 63 mm	_____	m	Ø 400 mm	_____	m
Ø 75 mm	_____	m	Ø 450 mm	_____	m
Ø 90 mm	_____	m	Ø 500 mm	_____	m
Ø 110 mm	_____	m	Ø 560 mm	_____	m
Ø 125 mm	_____	m	Ø 630 mm	_____	m

Start of test: _____

End of test: _____

Test period: _____

Test medium: water water/glycol

Client: _____

Contractor: _____

Place, Date

Stamp/Signature

FLUSHING OF PIPES / EARTH WIRE / TRANSPORT AND STORAGE

Flushing of pipes

The technical rule for potable water installations (TRWI)

DIN 1988, Part 2

includes a paragraph about the flushing of pipes, which has to be carried out with an air-water-mixture under pressure.

Basically all potable water plants, independent of their material, have to be flushed thoroughly after their installation. The following requirements have to be complied with before the installation can be put into service:

- Protection of the potable water quality
- Avoidance of corrosion damage
- Avoidance of malfunctions of armatures and apparatus.
- Cleanliness of the inner surface of the pipe

These requirements are met by

- Flushing with water
- Flushing with air-water-mixture

On choosing the type of flushing required, the experiences of the installer, the requirements of the client and the instructions of the system manufacturer have to be observed.

For potable water installations according to DIN 1988, realized with the aquatherm green pipe only, flushing with water will be sufficient.

The aquatherm green pipe system complies with DIN 1988 for potable water installations. Thus, flushing with water is sufficient, according to procedure 1 stipulated therein.

Earth wire

DIN VDE 0100, Part 701 contains safety measures for rooms containing baths or showers. Among other aspects, this standard regulates the potential balance for such rooms.

The standard stipulates that all conductive components such as metal baths and shower trays, metal outlet valves, metal stench traps and metal pipe systems (e. g. potable water and heating pipe systems) must be connected to each other.

The connection to an earth conductor must be provided, at a central point, e.g. in the building's mini-distributors installation (power circuit distributors).

Information on renovating potable water pipe systems using aquatherm green pipes:

Where metal pipes are replaced by aquatherm green pipes, the potential balance cannot be created by the water pipes.

It should be ensured that the potential balance is checked out by a qualified electrician.

aquatherm polypropylene pipes may be stored outside at any temperature. A solid base for the pipe is very important to avoid a deformation of the pipes while in transport and storage.

At temperatures below 0 °C it is possible to damage the pipes through strong impacts. The material has to be treated with caution at low temperatures.

In spite of its high resistance aquatherm pipes should be treated with care.

UV-radiation has effects on all high polymer plastics. Do not store permanently outdoor.

The maximum permissible storage time outdoors is 6 months.



Transport and storage

WATER POINT CONNECTIONS

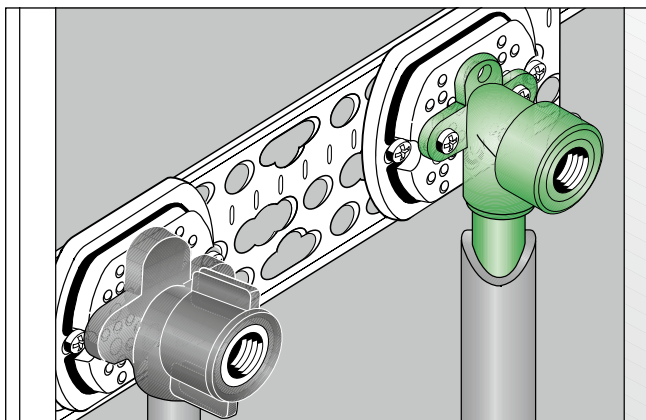

aquatherm green pipe back plate elbow for twin water point connections with galvanized mounting plate and sound insulation plate (Art. no. 7020000015) from the fixing program (gauge for bore holes 220-153-80 mm)

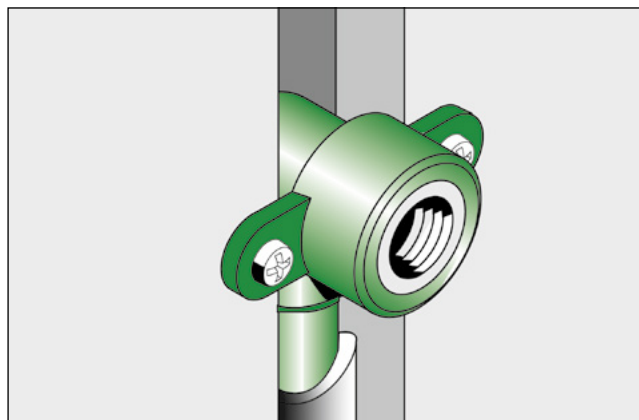

aquatherm green pipe back plate elbow for dry construction installed in a pipe chase

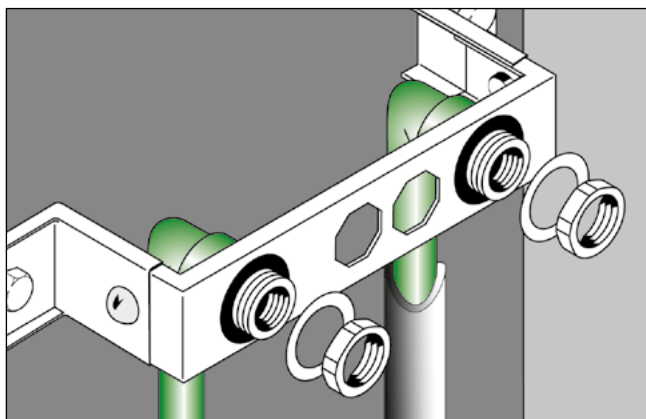

Mounting unit twin (gauge for bore holes 80-100-150 mm) incl. 2 aquatherm green pipe transition elbows female/male with counter nut, gasket and spring washer

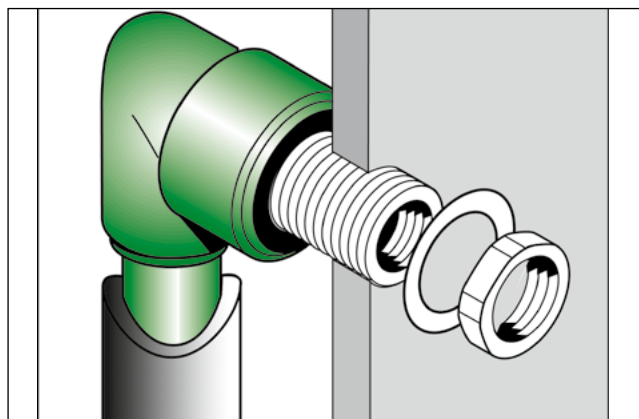

aquatherm green pipe transition elbow female/male for dry construction with 30 mm thread

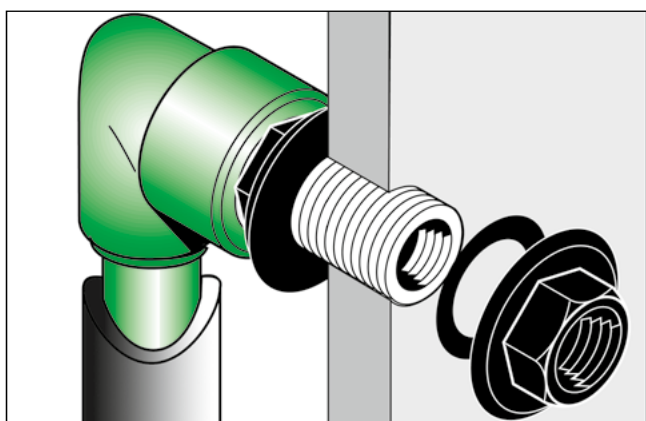

aquatherm green pipe dry construction wall fitting with transition elbow

The aquatherm green pipe transition elbow with female/male thread is suitable for flushing box connections. This transition elbow is also available with a single mounting unit.

**DISTRIBUTION BLOCK:
EXAMPLE OF APPLICATIONS**

Example of applications

The stamped numbers 1 and 2 indicate the proper connection of the aquatherm green pipe distribution block. They provide assistance with the installation.

In case of the "heating" connection variant (top A), the return is connected to the supply channel marked 1 and the flow to supply channel marked 2. The connections can also be used reverse.

In potable water connection variant (top C), supply channel 1 is intended for the cold water pipe and supply channel 2 for the hot water pipe connection. In as-delivered condition, the lower outlets are closed. The connection with supply channel 2 is made by drilling out (18 mm drill bit). Thus an additional pipe can be connected.

By turning the aquatherm green pipe distribution block a mirror-image connection can be made. These variants are presented in the illustrations B and D.

The flow and return connections of the aquatherm green pipe distribution block heating are installed with Ø 20 mm pipes. For radiator connections Ø 16 mm pipes have to be welded into the outflow sockets of the distribution block.

The aquatherm green pipe distribution block plumbing has to be connected with Ø 25 mm pipes. For pipe connections to the taps, Ø 20 mm pipes have to be welded into the outflow sockets of the distribution block.

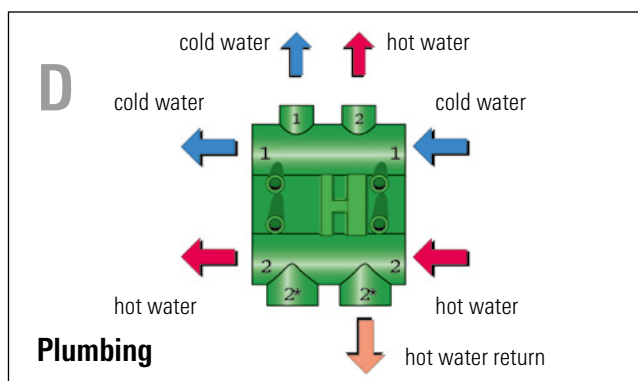
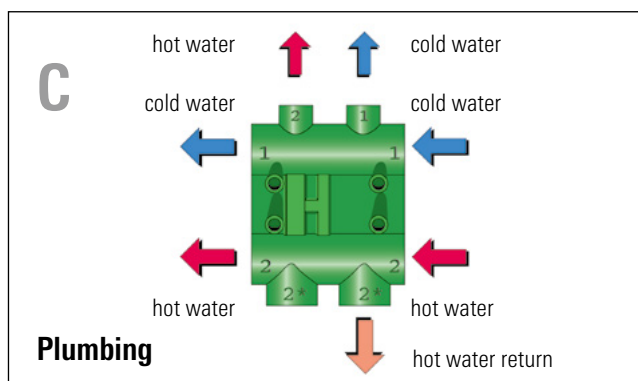
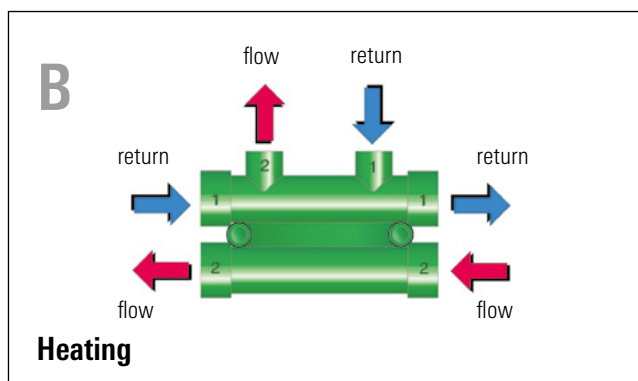
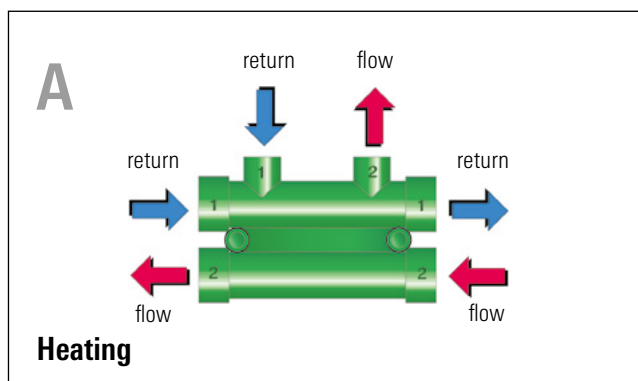

CHEMICAL RESISTANCE

Due to their special material properties aquatherm green pipe resp. aquatherm blue pipe and fittings are generally chemical resistant. However, aquatherm green pipe transition elements with thread inserts made of brass are not suitable for all media.

For industrial application of aquatherm green pipe and aquatherm blue pipe we recommend to use aquatherm green pipe flanges and/or coupling screws.

Note: On request, you will receive threaded inserts for aquatherm green pipe connecting pieces also in stainless steel. Prices on request.

INQUIRY FOR THE CHEMICAL RESISTANCE OF THE AQUATHERM GREEN PIPE AND AQUATHERM BLUE PIPE SYSTEM:

aquatherm GmbH

Technical department
Biggen 5 · D-57439 Attendorn
Phone: +49 2722 950 0
info@aquatherm.de · www.aquatherm.de

Installer:

Company

Contact

Street

PC/City

Phone

Fax

E-mail

Building project:

Address:

Street

PC/City

Place, Date/Signature

Field of application:

Flow medium

Operating temperature °C/°F

Working pressure bar/psi

Service life h/d

Concentration %

Ambient medium:

Ambient temperature °C/°F

Ambient pressure bar/psi

	Data sheets	enclosed	not enclosed
Fluid transported	<input type="checkbox"/>	<input type="checkbox"/>	<input type="checkbox"/>
Ambient medium	<input type="checkbox"/>	<input type="checkbox"/>	<input type="checkbox"/>



aquatherm

state of the pipe

EXPLANATORY COMMENTS ON THE AQUATHERM GMBH WARRANTY

1. Foreword

Thank you very much for making the decision to use a product from aquatherm GmbH, Germany (herein referred to as "aquatherm"). With more than 45 years of experience in the international plastic pipes market, and our trendsetting innovations, we have the expertise needed to offer you engineered piping solutions made in Germany.

The trust placed in the quality of our products has motivated us to offer all pipes and molded, fabricated, machined, and/or assembled parts with a 10-year warranty instead of the standard 2-year warranty required by German law. This extended time covered by warranty is backed by a comprehensive insurance policy from a leading insurance company for our line of business. The warranty period will begin with the date of delivery by aquatherm GmbH, but only becomes effective with the successful pressure test, which must be carried out and documented in accordance with the aquatherm specification.

2. Scope of warranty

The aquatherm warranty protects you from financial loss proven to be caused by material defects, manufacturing defects and/or aquatherm's consulting/engineering services. The warranty coverage shall apply for the following product groups:

- aquatherm green pipe (fusiotherm and aquatherm ISO)
- aquatherm blue pipe (climatherm and aquatherm ISO)
- aquatherm red pipe (firestop)
- aquatherm black system (climasystem)
- aquatherm lilac pipe (aquatherm lilac)
- aquatherm orange system (aquatherm heating systems)
- aquatherm grey pipe (aquatherm SHT system)
- assemblies fabricated by aquatherm from these product groups

2.1 What is covered by the aquatherm warranty?

The aquatherm warranty covers three aspects of damages: property damage, financial loss and personal injury.

2.1.1 What is property damage?

The damage to or destruction of a tangible item as a result of a defective product (e.g. classic water damages as a result of a leak). As a result of this, the suitability of the tangible item to fulfill its actual purpose is impaired. The term property damage is used if tangible items are damaged or destroyed. Considerable costs can be incurred as a result of property damage, such as renovation costs, repair costs or replacement costs.

2.1.2 What is meant by financial loss?

Financial loss may either be out-of-pocket loss or loss of business. Out-of-pocket financial loss is for example the costs of removing products and installing replacements after damage. Loss of business is the financial disadvantage suffered by an injured party as a result of a damaging event (e.g. lost income as a result of renovations following property damage).

2.1.3 What is meant by personal injury?

If a person suffers physical injury, this is known as personal injury. For the purposes of this document, the coverage of personal injury means the direct medical costs incurred as a result of the injury.

3. What is not covered?

Costs related to the damages incurred such as a result of:

- Non-compliance with the operating parameters defined and specified by aquatherm as found in aquatherm's technical documents. In cases of doubt, contact your local aquatherm manufacturer's rep. Exceptions must be provided for, in writing, by a member of aquatherm's engineering team.
- Non-compliance with the installation guidelines as set out in the aquatherm Catalogue, with emphasis to the required installation of aquatherm propriety clipping or other compatible with aquatherm piping.
- Non-compliance with respective National Plumbing Standards and Regulations.
- Joints which were not made in accordance with the aquatherm guidelines, including but not limited to: improper fusion technique, use of contaminated materials or tools, use of faulty or unsuitable tools, use of damaged materials or tools, or any connection made by an installer without sound knowledge of the aquatherm connection techniques and their processes.
- Improperly assembled connections to other pipeline systems and/or components (threads, flanges, stubs, mechanical joints not intended for use with aquatherm PP piping etc.).
- All sealing elements used in the product lines manufactured by aquatherm.
- Tools and accessories sold by aquatherm GmbH are covered for the warranty period by law under the statutory warranty provisions.
- Systems with defective pipeline sections or fittings that were not subjected to the aquatherm pressure test or alternative testing approved by aquatherm prior to start-up.
- Damage to our products caused by incorrect handling after the material has left aquatherm's possession.
- Damage caused or exacerbated by copper in the water resulting from erosion/corrosion or other degradation of copper components in a domestic hot water recirculating system.
- Time delay, caused by incorrect planning, delivery problems and/or incorrect orders.
- Damage caused by entrained air, cavitation and pressure fluctuations.

Note: This list only includes the most prominent examples. Other circumstances, which compromise the integrity of the products, may also jeopardize the coverage.



aquatherm

state of the pipe

EXPLANATORY COMMENTS ON THE AQUATHERM GMBH WARRANTY

4. How is the amount of compensation under the aquatherm warranty determined?

In the event of a material failure, samples of the damaged/faulty product are collected by the national aquatherm partner to forward them to aquatherm GmbH for examination and analysis. Working in collaboration with the injured party, aquatherm will identify the cause of the damage, and call in external bodies (test institutes, laboratories, assessors, etc.) as needed. If the damage has been caused by a material and/or manufacturing defect or by aquatherm's consulting/engineering services, the underwriter shall quantify the compensation claim for damages. All expenditures associated with the damages for this claim must be verified/recorded in detail and in a verifiable format as a required measure.

5. How much is the maximum coverage?

For the first 5 years of the warranty period, property damage, personal injury and financial loss is covered for the sum of €20 million per insurance claim. Total coverage for all claims made in a year is a maximum of €40 million. For years 6-10 of the warranty period, these coverage amounts are €7.5 and €15 million respectively.

6. Why is the coverage stated in Euro?

The insured manufacturer, aquatherm, as well as the insurer, are both based in the EU, so that their agreements are issued in Euros (€). Since exchange rates fluctuate, the exchange rate current on the date of compensation shall apply.

7. What is the channel of communication for notifying claims under warranty and making inquiries about them?

Warranty claims have to be made to aquatherm via the national aquatherm GmbH partners. Information about the progress of the claim will only be released by the aquatherm partner or aquatherm GmbH.

8. Legal note

If a discrepancy or conflict arises between this document and the underlying insurance policy, the latter shall in all cases prevail.

If a discrepancy or conflict arises between this translated document and the German document, the German document shall in all cases prevail.

9. Information about avoiding damage

I) **Manufacture under certified quality level**

As a trusted manufacturer, aquatherm works to a certified quality standard (ISO 9001); constant internal quality controls are part of the daily routine. In addition to this, all employees are integrated into a quality assurance program. As a result of this, products failing to comply with our high standards are quickly identified and removed from our product range.

II) **Preventing damage caused by incorrect handling**

Our products must be handled conscientiously and carefully when they are delivered from our production plants. Experience shows that most damage is caused in transit, storage and/or when working on site. At this point we would draw close attention to the fact that correct handling contributes to maintaining the product quality.

III) **Work is to be carried out by qualified installers**

Installation defects are easy to avoid. Our training courses teach the correct techniques in detail for working with our products. In doing so, particular importance is attached to work being carried out attentively and with care. The work of installers trained by us or our aquatherm partners is much more reliable and carried out much more efficiently.

For a safe connection, we recommend using only aquatherm PP products in a piping system. Mixing with other PP piping systems should be avoided.

June 2020
aquatherm GmbH, Biggen 5, 57439 Attendorn, Germany

PLANNING

DIN 1988 T3 / MAXIMUM FLOW RATE / PRINCIPLES OF CALCULATION / CAD AND BIM DATA

DIN EN 806 PART 3 AND DIN 1988 PART 300

DIN EN 806 part 3 and DIN 1988 part 300 (Technical Rules for Potable Water Installations) specifies the calculation principles for the determining of the pipe diameter.

The determining of the pipe diameter is based on the calculation of the pressure loss in pipes.

Beside the diameter the pressure loss depends on the length of the pipe, the pipe material and on the flow rate, dependent on the quantity and size of the water points to which the pipe is connected.

The basis for determining the maximum flow rate should be calculated on the desired flow rate of each water point. The simultaneous use resp. the peak pressure of flow of an installation part has to be determined by taking the calculation values from DIN 1988 T 3 as a basis.

Maximum flow rate

A further criterion for the selection of the pipe diameter is the maximum permissible flow rate. Because of sonic reasons and for the limitation of water hammer, the calculated flow rate may not exceed the values of the table below.

DIN EN 806-part 3

Collective supply pipes, riser pipes, storey pipes max. 2,0 m/s;
Individual supply pipes max. 4,0 m/s

NOTE: National regulations may require lower flow rates to avoid water hammers and noise.

DIN1988 part 300 table 5 – Maximum calculated flow rate in case of the related peak flow

Section of the installation	max. calculated flow rate at run (m/s)	
	< 15 min.	≥ 15 min.
Connecting pipes (Building connection)	2	2
Supply pipelines: Sections with resistance coefficients $\xi < 2,5$ for individual resistances ^a	5	2
Sections with resistance coefficients $\xi \geq 2,5$ for individual resistances ^b	2.5	2

^a i. e. piston valves acc. to DIN 3500. ball cock. inclined valves acc. to DIN 3502 (from DN 20)

^b i. e. screw-down stop globe valves acc. to DIN 3512

Principles of calculation

To determine the pipe diameter in potable water networks of buildings numerous principles of calculation are necessary. The revised version of DIN 1988 provides a simplified and differentiated method of calculation.

The simplified method is suitable for clearly arranged pipes i. e. in residential buildings. The differentiated method includes all pipes and local resistances and offers the highest accuracy as well as the most accurate approximation of real operating conditions. The determining of the pipe diameter requires the following data:

- Minimum gauge pressure of supply or pressure in flow direction behind pressure reducing or boosting valve
- Head variations
- Pressure loss due to apparatus i. e. watermeter, filter, softening installations etc.
- Minimum flow pressure of the water point applied
- Pipe friction factor of the used pipe material
- Coefficients of loss for fittings and pipe connections

CAD and BIM data

We provide data sets for the following calculation programmes:

- MagiCAD
- liNear

Further data set formats can also be downloaded from our homepage:

- RFA
- STP
- IPT
- DWG

For any questions, please contact our aquatherm information service:
+ 49 2722 950 0



MINIMUM FLOW PRESSURE

Minimum flow pressures and minimum values for the calculation flow of common potable water tapping points

Type of tapping point		DN	Minimum flow pressure p_{minFl} MPa	Calculation flow V_R l/s
Taps	without aerator ^a	15	0,05	0,3
		20	0,05	0,5
		25	0,05	1
	with aerator	10	0,1	0,15
		15	0,1	0,15
Mixing taps ^{b, c} for	Shower tub	15	0,1	0,15
	Bath tub	15	0,1	0,15
	Kitchen sink	15	0,1	0,07
	Washbasin	15	0,1	0,07
	Bidet	15	0,1	0,07
Toilet and urinal	Filling valve for flushing tank (acc. to DIN EN 14124)	15	0,05	0,13
	Flushing valve (manual) for urinal (acc. to DIN EN 12541)	15	0,1	0,3
	Flushing valve (electronic) for urinal (acc. to DIN EN 15091)	15	0,1	0,3
	Flushing valve for toilet	20	0,12	1

Important instructions:

The manufacturers must specify the minimum flow pressure and the calculation flows on the cold and hot water side (for mixer fittings). Basically, the information of the manufacturers must be taken into account for the dimensioning of the pipe diameter, which can sometimes differ considerably from the values given in this table. Proceed as follows:

If the manufacturer's specifications for the minimum flow pressure and the calculation flow are **below** the values given in the table, there are two options:

- If the potable water installation is dimensioned for the lower values for hygienic and economic reasons, this procedure must be agreed with the building owner and the design requirements for the tapping points (minimum flow pressure, calculation flow) must be included in the dimensioning.
- If the potable water installation is not designed for the lower values, the table values must be considered.

If the manufacturer's specifications are **above** the values given in the table, the potable water installation **must** be dimensioned using the manufacturer's values.

a Without connected equipment (e.g. lawn sprinkler)

b The specified calculation flow must be considered for the cold and hot water connections

c Corner valves for e.g. washbasin fittings and S-connections for e.g. shower- and bathtub fittings are to be considered as individual resistors or in the minimum flow pressure of the tap.

MIMINUM FLOW PRESSURES

Total flow

Contrary to the flow direction – starting at the most distant tapping point and normally ending at the domestic water meter – the calculation flows have to be added and the total flows obtained in this way have to be assigned to the corresponding sections.

Permanent flows are to be shown separately in the calculation and the calculation plan.

The respective section begins with the fitting on which the total flow or the diameter or the pipe material changes.

1.1 1.1 Peak flow

The simultaneity of water withdrawal depends on the type of use (e.g. in apartments, hotels, etc.). In general, it cannot be expected that all connected tapping points will be fully open at the same time.

For the building types listed in table 3, the peak flow is within the scope

$0,2 \leq \sum VR \leq 500$ calculated using equation (9)

$$V_s = a (\sum V_R)^b - c v_s = a$$

It is

v_s = the peak flow

V_R = the calculation flow according to table 2

a, b, c = the constants according to table 3

Table 3 – Constants for peak flow according to equation (9)

BUILDING TYPE	CONSTANT		
	a	b	c
Residential buildings	1,48	0,19	0,94
Hospital ward	0,75	0,44	0,18
Hotel	0,7	0,48	0,13
School	0,91	0,31	0,38
Administration building	0,91	0,31	0,38
Assisted living facility, retirement home	1,48	0,19	0,94
Nursing home	1,4	0,14	0,92

The following exceptions apply:

- **Usage units**

Experience has shown that the flows in the direction of flow towards the end of the branch line and in the floor distribution of usage units according to equation (9) are too high, because no more than two tapping points are open at the same time, e.g. in a bathroom. Therefore, the peak flow in each section of an usage unit is set to maximum of the total flow of the two largest tapping points installed on the section (also applies to cases in an usage units where equation (9) results in a smaller flow). If a second usage unit is connected to a section (e.g. in the riser), the peak flows of the two usage units add up, provided that the resulting peak flow is smaller than calculated according to equation (9). Otherwise the peak flow has to be determined according to equation (9).

- **Continuous consumer**

The flow with continuous consumption is added to the peak flow of the other tapping points. Water withdrawals with a duration of more than 15 minutes are regarded as continuous consumption, e.g. garden sprinkler valve.

- **Systems in series**

The basis for the calculation is the total flow. The simultaneity of water withdrawal must be determined with the operator. The peak flows of the system in series and other sections in the building should be added if they can occur at the same time.

MIMINUM FLOW PRESSURES

Determination of the peak flow rate V_S from the total flow $\sum V_R$ for residential buildings

according to DIN 1988 part 3











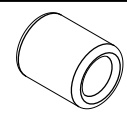



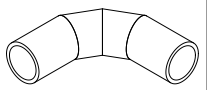

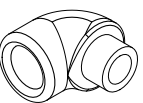

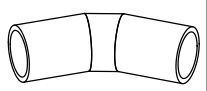

$$V_S = 1,7 \cdot (\sum V_R)^{0,21} - 0,7 \text{ [l/s]}$$

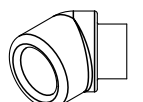
Special buildings, commercial and industrial plants

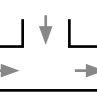
For special buildings (i.e. building types other than those listed in table 3) and potable water installations in commercial and industrial plants, special considerations must be made regarding the simultaneousness of water withdrawal.

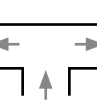

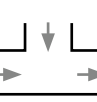
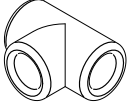
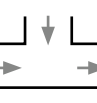
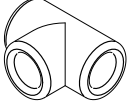
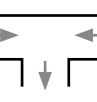

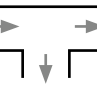
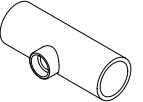
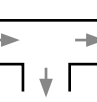
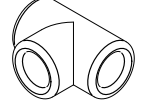
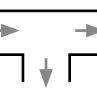









In industrial, agricultural, gardening, slaughterhouse, dairy, laundry companies, canteen kitchens, public baths, etc., the peak flow must be determined from the total flow in consultation with the operator of the system. This also applies to subareas of potable water installations, e.g. commercial companies in residential buildings. The peak flows of the subareas of the potable water installation are to be added if they coincide in time.

Coefficient of loss ζ aquatherm green pipe- & aquatherm blue pipe-fittings

Fitting	Drawing	Graphic illustration	ζ -Value																			
			16	20	25	32	40	50	63	75	90	110	125	160	200	250	315	355	400	450	500	630
Socket			0,8	0,5	0,5	0,7	0,9	0,2	0,2	0,2	0,2	0,2	0,2	0,2	0,2	0,2	0,2	0,2	0,2	0,2	0,2	0,2
Elbow 90°			2	1,3	1,2	2	1,9	0,5	0,5	0,7	0,7	0,7	0,7	0,7	0,7	0,7						
Segment Elbow 90°																0,8	0,8	0,8	0,8	0,8	0,8	0,8
Elbow 90° m.f.				1,3	1,2	2	1,9															
Elbow 45°				2	1,9	1,9	0,5	0,4	0,4	0,4	0,4	0,4	0,4	0,4	0,4	0,4						
Elbow 45°																0,4	0,4	0,4	0,4	0,4	0,4	0,4
Elbow 45° m.f.				2	1,9	1,9	0,5															
Tee			1,1	0,9	0,9	0,9	0,6	0,2	0,2	0,2	0,2	0,2	0,2	0,2	0,2	0,2	0,2	0,2	0,2	0,2	0,2	0,2
Tee			0	0,3	0,3	0,4	0,7	0,7	1,1	1,3	1,3	1,3	1,3	1,3	1,3	1,3	1,3	1,3	1,3	1,3	1,3	1,3
Tee			2	1,9	1,8	1,8	1,6	1,6	1,6	2	2	2	2	2	2	2	2	2	2	2	2	2
Tee			3,8	3,5	3,2	3,2	3	3,2	3,2	4	4	4	4	4	4	4	4	4	4	4	4	4
Tee			2,2	2,3	2,3	2	1,6	1,9	1,9	2,7	2,7	2,7	2,7	2,7	2,7	2,7	2,7	2,7	2,7	2,7	2,7	2,7
Tee			2,4	2,6	1,4	2,3	1,8	1,2	1,1	1,2	1,2	1,2	1,2	1,2	1,2	1,2	1,2	1,2	1,2	1,2	1,2	1,2
Reducing tee (saddle technology)			The zeta value results from the addition of the zeta values T-piece and red. piece																			
Reducing tee			The zeta value results from the addition of the zeta values T-piece and red. piece																			

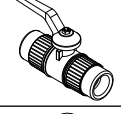
(→ = flow direction)

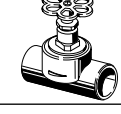
Coefficient of loss ζ aquatherm green pipe- & aquatherm blue pipe-fittings

Fitting	Drawing	Graphic illustration	ζ -Value																			
			16	20	25	32	40	50	63	75	90	110	125	160	200	250	315	355	400	450	500	630
Reducer			2,4	1,9	1,9	1,9	0,2	0,2	0,2	0,2	0,2	0,2	0,2	0,2	0,2	0,2	0,2	0,2	0,2	0,2	0,2	0,2
Back plate				3,7	3,7																	
Back plate				3,5	3,5																	
Back plate				2	2																	
Stop valve/ inclined valve				2	2	2	2															
Ball valve				0,3	0,3	0,3	0,3	0,3	0,3	0,3	0,3	0,3	0,3	0,3	0,3	0,3						
Screw-down stop globe valve				7	7	7	7															

(→ = flow direction)

Source: DIN 1988 Part 3

$$Z = \frac{\zeta v^2 \delta}{2}$$

Z = Pressure lost in [Pa]

v = Flow rate [m/s]

ζ = Coefficient of loss of fitting

δ = Density of medium [kg/m³]

K_v = volume flow [m³/h] of water [5–30 °C] at a pressure difference of 1 bar

Note: For the determination of pressure loss in (mbar) the result has to be divided by the factor 100 (100Pa = 1 mbar).

Notice on planning & design of compressed air applications

When planning and designing pipe systems for compressed air applications, the following working pressures are to be observed.

<p>aquatherm green pipe SDR 9</p>
<p>10 bar (145 psi)</p>

This chart is valid for temperatures from 10 °C to 40 °C. For temperatures and conditions other than those noted in the chart, please contact our technical service department.

Warning: Failure of a compressed gas (air or inert gas) system can be extremely violent and dangerous. In a compressed gaseous media piping system, energy is applied to compress the gaseous media in addition to pressurizing the system. If failure occurs, both energies can be suddenly released and can be extremely violent compared to failure during leak testing or system operation with an incompressible liquid testing media.

aquatherm recommends that thermoplastics piping intended for the transport of compressed air or other compressed gases should be buried, encasement in shatter-resistant material or other appropriate means, to prevent or minimize the possibility of mechanical damage. The piping must also be protected from other sources of degradation such as ultraviolet light (UV) exposure, chemical effects, temperature and oxidation.

Always make sure to eliminate risks for persons near compressed air systems, also observing the applicable national and international regulations of installation, accident prevention and safety for the installation of pipe systems, as well as the applicable laws, standards, guidelines and technical rules.

Coefficient of loss ζ aquatherm green pipe distribution block

Picture	Comment	Picture	Comment	ζ -Value	
Potable water installation Cold water Hot water 	Reduced 25 mm passage in case of separation of flow	Heating installation Return Flow 	Reduced 20 mm passage in case of separation of flow	1.00	
	25 mm passage in case of separation of flow		20 mm passage in case of separation of flow	0.25	
Potable water installation Cold water Hot water 	20 mm passage in case of separation of flow	Heating installation Return Flow 	16 mm branch in case of separation of flow	0.80	
	20 mm branch in case of conjunction of flow		16 mm branch in case of conjunction of flow	1.60	
	Reduced 20 mm passage in case of separation of flow		16 mm branch in case of separation of flow	2.20	
Potable water installation Cold water Hot water 		Heating installation Hot water Cold water Hot water return 		25 mm branch in case of separation of flow	1.20
				16 mm branch in case of conjunction of flow	0.80

TERMS AND CONDITIONS

Important note regarding our sales, warranty and delivery conditions:

Our sales and delivery conditions (issue: 2014) as well as the contact details of our technical sales department and our representatives can be found on our website www.aquatherm.de.

Errors, misprints and technical modifications reserved. With the appearance of this catalogue all previous issues become void.



Management
System
ISO 9001:2015
ISO 14001:2015
ISO 50001:2011
www.tuv.com
ID 0091005348

aquatherm GmbH

Biggen 5 | 57439 Attendorn | Tel.: +49 2722 950 0

info@aquatherm.de | www.aquatherm.de

Order-No.: 9800000049
Edition: 01.2022

aquatherm green pipe - Pipe system made of polypropylene For potable water supply